

Amplifier Built-in Type Laser sensor EX-L200 Series

MJE-EXL200 No.0042-03V

Thank you very much for purchasing Panasonic products. Please read this Instruction Manual carefully and thoroughly for the correct and optimum use of this product. Kindly keep this manual in a convenient place for quick reference.

WARNING

- Never use this product as a sensing device for personnel protection.
- In case of using sensing devices for personnel protection, use products which meet laws and standards, such as OSHA, ANSI or IEC etc., for personnel protection applicable in each region or country.
- This product is classified as a "Class 1 laser product" by IEC / JIS standard, GB standard and FDA.
- Do not look the laser directly. Lasers are potentially hazardous. Furthermore, do not view the laser which is reflected at a specular object.
- Never disassemble, repair or modify the product.
- In case of control or adjustment using procedures other than those specified in this instruction manual, hazardous laser radiation exposure can result.

1 FOR SAFE USE OF A LASER PRODUCT

- In order to prevent the accident by laser product and protect the users, JIS C 6802-2005 "Safety of laser products" was established based on the regulation of IEC (International Electrotechnical Commission). This regulation classifies laser products according to the level of hazard, and provides the safety measures for respective classes.

This product are classified as "Class 1 laser products" according to IEC 60825-1-2007 (JIS C 6802-2005) "Safety of laser products".

- This product complies with 21 CFR 1040.10 and 1040.11 based on Laser Notice No. 50, dated June 24, 2007, issued by CDRH (Center for Devices and Radiological Health) under FDA (Food and Drug Administration).
- For details, refer to the Laser Notice No. 50.

Laser hazardous class

Classification according to IEC 60825-1-2007 (JIS C 6802-2005)

Classification	Description
Class 1	Safe under reasonably foreseeable conditions.

Label

- Following labels are affixed on this product based on the IEC 60825-1 standard.

<Warning label>



Certification / Identification label

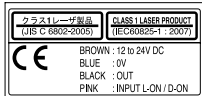

Warning label

<Label position>

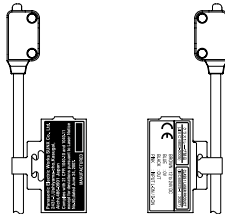

2 PART DESCRIPTION

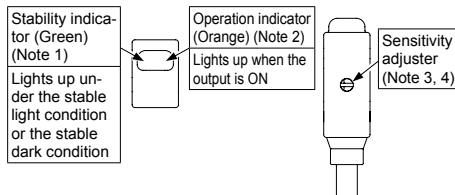

- Notes: 1) Not incorporated on the emitter of thru-beam type.
 2) It is the power indicator (Green: lights up when the power is ON) for the emitter of thru-beam type.
 3) It is not incorporated in emitter of EX-L211□. It is not incorporated in EX-L212□.

3 MOUNTING

- In case mounting this device, use a metal plate **MS-EXL2-□** (accessory).
- The tightening torque should be 0.5N·m or less with M3 screws.

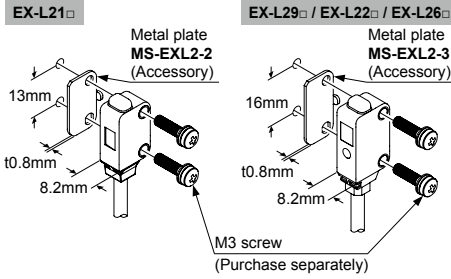

- In case using the dedicated sensor mounting bracket (optional) when mounting this device, the metal plate **MS-EXL2-□** (accessory) is required depending on the mounting direction. Mount as the diagram below indicates.

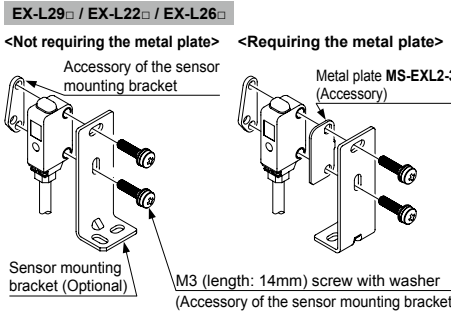
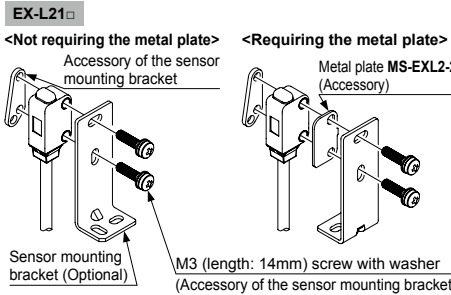

- In case not using the metal plate **MS-EXL2-□** (accessory) when mounting this product, work on the mounting hole as the diagram below indicates.

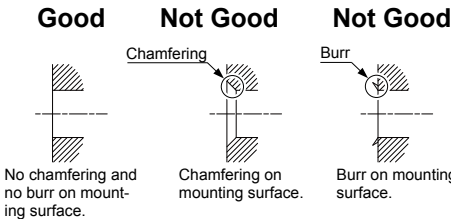
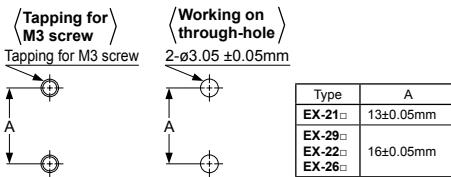

- After mounting the thru-beam type, be sure to adjust light axis of the emission spot to hit the center of the receiver.

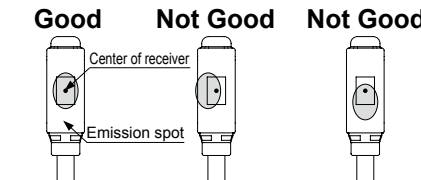

4 WIRING

- Make sure to use the cable with connector, **CN-24A-□-□** (optional), when connecting to the pig-tailed type.
- Tighten the fixing ring of the cable with connector completely by hand when mounting. (The tightening torque: 0.2N·m)
- If the fixing ring is tightened by a tool such as pliers, it may cause connector damage.
- If the tightening is not enough, the fixing ring may loosen due to vibration, etc.

Connecting method

- Insert the cable with connector into a connecting area of this product, and twist the fixing ring of the cable with connector to be fixed.

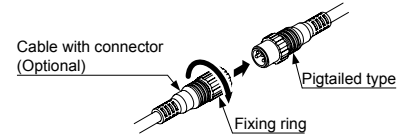

Disconnecting method

- Loosen the fixing ring and pull to separate the connector by holding the fixing ring.

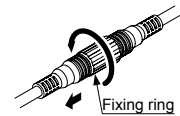

Note: Before disconnecting, be sure that the fixing ring is completely loosened. If the cable is pulled by excessive force (15N or more) when the fixing ring is tightened, the cable may break.

5 I/O CIRCUIT DIAGRAMS

• NPN output type

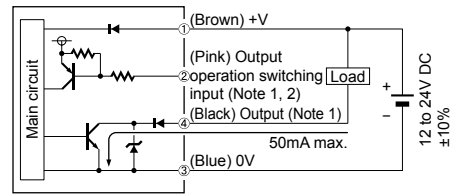

• PNP output type

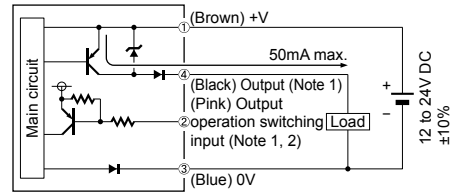

- Notes: 1) The emitter of thru-beam type dose not incorporate output (black) and output operation switching input (pink).
 2) Be able to select either Light-ON or Dark-ON by wiring the output operation switching input (pink) as a following table.

	Light-ON	Dark-ON
Thru-beam type	Wire to 0V	Wire to +V or Open
Mirror reflective type		
Spot reflective type	Wire to +V or Open	Wire to 0V
Fixed-focus reflective Type		

<Terminal arrangement>

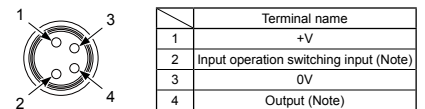

Note: The emitter of thru-beam type dose not incorporate output and output operation switching input.

6 SENSITIVITY ADJUSTMENT

Step

- Turn the sensitivity adjuster fully counter-clockwise to the minimum sensitivity position (MIN).
- In the light received condition, turn sensitivity adjuster slowly clockwise and confirm the point A where the sensor enters the "Light" state operation.
- In the dark condition, turn sensitivity adjuster further clockwise until the sensor enters the "Light" state operation and then bring it back to confirm point B where the sensor just returns to the "Dark" state operation.
(If the sensor does not enter the "Light" state operation even when the sensitivity adjuster is turned fully clockwise, this extreme position is point B.)
- The position at the middle of point A and B is the optimum sensing position.

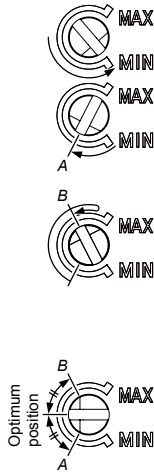

Note: Use the flathead screwdriver (please arrange separately) to turn the adjuster slowly. Turning with excessive strength will cause damage to adjuster.

7 AUTOMATIC INTERFERENCE PREVENTION FUNCTION

- Retroreflective type, Spot reflective type and convergent type sensor incorporate this function. Up to two sets of sensor can be mounted closely. (Thru-beam type sensor does not have this function.)

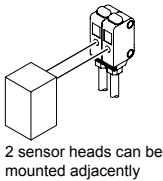

Note: If two spot reflective type sensor are mounted facing each other, they should be angled so as not to receive the beam from the opposing sensor or to detect its front face.

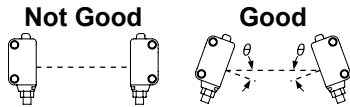

8 POLARIZING FILTER PF-EXL2-1 (Optional) (Only for mirror reflective type EX-L291□)

- By installing the polarizing filter PF-EXL2-1 (optional) to the mirror reflective type EX-L291□, mirror surface object and glossy object are not detected.
- Install the polarizing filter to EX-L291□ before mounting EX-L291□.

Mounting method

- Face up a large window of front side of the polarizing filter.
- Slide from sensing side and push until it clicks.

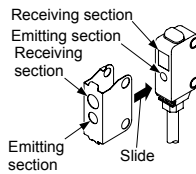

Removing method

- Open the side (tabs on the side) of the polarizing filter with flat-blade screwdriver and push the polarizing filter.

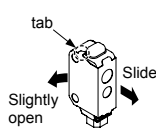

- Notes: 1) When removing the polarizing filter, opening widely makes the filter lose original form and it cannot be used again.
2) Be sure not open the polarizing filter by flinger, it may lead injury.
3) Be sure not contacting with water etc. when the polarizing filter is mounted.
4) Do not contaminate with fingerprints or skin oil on the polarizing filter.
5) In case mounting polarizing filter, make sure leave 400mm or more between this product and the reflective mirror RF-330 (optional).
6) In case installing the reflective mirror at close distance, the angular characteristic becomes narrow. Conduct fine adjustment of angle for this product or the reflective mirror.

- When using the polarizing filter (optional), need attention to mount reflective mirror shown below.

<Correct mounting method>

- Mount the reflective mirror horizontally or vertically toward EX-L291□.

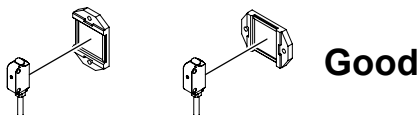

<Correct mounting method>

- The reflective mirror must not be tilt toward the EX-L291□.



9 SPECIFICATIONS

• Individual Specification

Type	Thru-beam type			Retroreflective type
	Long distance			
Model No. (Note 1, 2)	2m cable Pigtailed	EX-L211(-P) EX-L211(-P)-J	EX-L212(-P) EX-L212(-P)-J	EX-L291(-P) EX-L291(-P)-J
Sensing range	1m	3m	4m [with reflective mirror RF-330 (accessory)] (Note 3)	
Emission spot size (typical)	Approx. 6 × 4mm (vertical × horizontal) (at 1m sensing range) (Note 4)	Approx. 8 × 5.5mm (vertical × horizontal) (at 1m sensing range) (Note 4, 5)	Approx. 6 × 4mm (vertical × horizontal) (at 1m sensing range) (Note 6)	
Sensing object	ø2mm or more of opaque object	ø3mm or more of opaque object	ø25mm or more of opaque or translucent object	
Minimum sensing object (typical) (Note 7)	ø0.3mm of opaque object (at 1m sensing range)	—	—	
Current consumption	Emitter: less than 10mA, Receiver: less than 10mA		15mA or less	
Hysteresis (typical)	—		20% of operation distance (Note 8)	
Interference prevention function	—		Incorporated (2 heads are possible to mount adjacently)	
Weight	2m cable Pigtailed	Emitter: Approx. 40g, Receiver: Approx. 40g Emitter: Approx. 10g, Receiver: Approx. 10g	Approx. 45g Approx. 10g	
Accessory	MS-EXL2-2 (Metal plate): 2 pcs.			RF-330 (Reflector): 1 pc. MS-EXL2-3 (Metal plate): 1 pc.

Type	Spot reflective type	Convergent type		
		Line spot		
Model No. (Note 1, 2)	2m cable Pigtailed	EX-L221(-P) EX-L221(-P)-J	EX-L261(-P) EX-L261(-P)-J	EX-L262(-P) EX-L262(-P)-J
Sensing range	45 to 300mm (Note 8)	20 to 50mm (Center 22mm) (Note 8)	20 to 70mm (Center 22mm) (Note 8)	
Emission spot size (typical)	Less than ø1mm (at 300mm sensing range) (Note 6)	Less than ø1mm (at 50mm sensing range) (Note 6)	Approx. 5 × 1mm (vertical × horizontal) (at 50mm sensing range) (Note 6)	
Sensing object	Opaque, translucent or transparent object			
Minimum sensing object (typical) (Note 7)	ø0.01mm of gold wire			
Current consumption	15mA or less			
Hysteresis (typical)	20% of operation distance (Note 8)			
Interference prevention function	Incorporated (2 heads are possible to mount adjacently)			
Weight	2m cable Pigtailed	Approx. 45g Approx. 10g		
Accessory	MS-EXL2-3 (Metal plate): 1 pc.			

• Common Specification

Supply voltage	12 to 24V DC ±10% Ripple P-P 10% or less
Output	<p><NPN output type> NPN open-collector transistor • Maximum sink current: 50mA • Applied voltage: 26.4V DC or less (between output and 0V) • Residual voltage: 2V or less (at 50mA sink current) 1V or less (at 16mA sink current)</p> <p><PNP output type> PNP open-collector transistor • Maximum source current: 50mA • Applied voltage: 26.4V DC or less (between output and +V) • Residual voltage: 2V or less (at 50mA source current) 1V or less (at 16mA source current)</p>
Output operation	Light-ON / Dark-ON Select by the output operation switching input
Short-circuit protection	Incorporated
Response time	0.5ms or less
Protection	IP67(IEC)
Ambient temperature	-10 to +55°C (No dew condensation or no icing condition) Storage: -30 to +70°C
Ambient humidity	35 to 85% RH, Storage: 35 to 85% RH
Emitting element	Red semiconductor laser class 1 (IEC / JIS / GB / FDA) Peak emission wavelength: 655nm, Maximum output: 0.39mW for EX-L21□, 0.5mW for EX-L291□ 2mW for EX-L221□, 1mW for EX-L261□ 1.3mW for EX-L262□
Material	Enclosure: PBT, Front cover / Light-receiving lens: Acrylic Light-emitting lens: Glass, Indicator: Polyarylate
Cable	2m cable 0.15mm ² 4-core (emitter: 2-core) cabtyre cable, 2m long Pigtailed 0.15mm ² 4-core (emitter: 2-core) cabtyre cable, 0.2m long

- Notes: 1) The model No. with suffix "E" shown on the label affixed is the emitter, "D" shown on the label is the receiver.
Emitter: EX-L221E, Receiver: EX-L211D
- 2) The model No. with suffix "-P" is PNP output model.
<Example> PNP output model of EX-L211 is "EX-L211-P."
The model No. with suffix "-CS" is 5m cable model.
<Example> 5m cable model of EX-L211-P is "EX-L211-P-CS."
The model No. with suffix "-Y" is no reflector type.
<Example> No reflector type of EX-L291-P is "EX-L291-P-Y."
- 3) Make sure leave 200mm or more between this product and the reflective mirror RF-330 (accessory).
4) The beam of emitter may enter receiver even if it is out of the range of the emission spot. In case using this devices as cascaded, we recommend to mount emitters and receivers alternately. In case mounting this devices in another method, be sure to check the operation with this device.
5) In case the sensing distance is 3m, the emission spot size is 17 × 11mm (vertical × horizontal) (visual reference value.)
6) In case high reflective object is existing between this product and the sensing object, this product may detect it.
7) Make sure to confirm detection with an actual sensor before use.
8) The sensing distance and the hysteresis of spot reflective type and fixed-focus reflective type is value for non-gloss white paper (100 × 100mm).
9) Make sure to use the flowing cables when connecting the pigtailed type.
<Straight Cable>
CN-24A-C2 (Cable length: 2m), CN-24A-C5 (Cable length: 5m)
<Elbow cable>
CN-24AL-C2 (Cable length: 2m), CN-24AL-C5 (Cable length: 5m)

10 CAUTIONS

- This product has been developed / produced for industrial use only.
- Make sure to carry out wiring in the power supply OFF condition.
- Take care that if a voltage exceeding the rated range is applied, or if an AC power supply is directly connected, the product may get burnt or damaged.
- Take care that short circuit of the load or wrong wiring may burn or damage the product.
- Do not run the wires together with high-voltage lines or power lines, or put them in the same raceway. This can cause malfunction due to induction.
- Verify that the supply voltage variation is within the rating.
- If power is supplied from a commercial switching regulator, ensure that the frame ground (F.G.) terminal of the power supply is connected to an actual ground.
- In case equipment generating noise (switching regulator, inverter motor, etc.) is used in the vicinity of this product, connect the frame ground (F.G.) terminal of the equipment to an actual ground.
- Do not use during the initial transient time (approx. 50ms) after the power supply is switched ON.
- In case the load and this sensor are connected to different power supplies, be sure to turn ON the power from the sensor.
- Extension up to total 100m or less, is possible with more than 0.3mm² of electric conductor cross-sectional area cable. However, in order to reduce noise, make the wiring as short as possible.
- Make sure that stress by forcible bend or pulling is not applied to the sensor cable joint.
- The cable may break by applying excess stress in low temperature.
- Take care that the sensor is not directly exposed to fluorescent lamp from a rapid-starter lamp, a high frequency lighting device or sunlight etc., as it may affect the sensing performance.
- In case of mounting the fixed-focus reflective type, the sensing may be influenced from reflective object in the back ground of the sensing object such as conveyor. In case of sensing the reflective object, mount the sensor with some angles or keep distance from the reflective object when mounting the sensor.
- This product is suitable for indoor use only.
- Do not allow any water, oil fingerprints, etc., which may refract light, or dust, dirt, etc., which may block light, to stick to the emitting / receiving surfaces of the sensor head. In case they are present, wipe them with a clean, soft cloth or lens paper.
- Do not use this sensor in places having excessive vapor, dust, etc., or where it may come in contact with corrosive gas, etc.
- Take care that the sensor does not come in contact with oil, grease, organic solvents such as thinner, etc., strong acid, or alkaline.
- Make sure that the power is OFF while cleaning the emitting / receiving windows of the sensor head.
- This device is using a laser which has high directional quality. Therefore the beam possibly be out of alignment by the mounting condition of this device or distortion of housing etc. Make sure to adjust the beam axis alignment before use.
- Since vibration, impact and ambient temperature affect the sensitivity, the insulation and the sensitivity adjustment must have some margins.

11 CE MARKED PRODUCT

- The model listed under "9 SPECIFICATIONS" comes with CE Marking. As for all other models, please contact our sales office.



- Contact for CE**
Panasonic Marketing Europe GmbH Panasonic Testing Center
Winsbergring 15, 22525 Hamburg, Germany

Panasonic Industrial Devices SUNX Co., Ltd.
http://panasonic.net/id/pids/global

Overseas Sales Division (Head Office)
2431-1 Ushiyama-cho, Kasugai-shi, Aichi, 486-0901, Japan
Phone: +81-568-33-7861 FAX: +81-568-33-8591

About our sales network, please visit our website.

© Panasonic Industrial Devices SUNX Co., Ltd. 2013
PRINTED IN JAPAN