

HRF-HD Series

Heavy Duty Foot Switches

- Suitable for industrial machinery, medical etc.
- Aluminum die-casting body
- Various safety features



Specifications

	HD3	HD3N	HD3NX	HD3LX	HD3NS	HD5NX	HD5NS	HD202P
Contact	1NO 1NC				1NO 1NC x 2ea			
Regular Current	15A 125/250VAC							
Built-in Switch	Z type Micro Switch (UL, cUL, CE certified)							
Body Material	Aluminum Die-casting							
Function	Momentary							
Degree of Protection	IP65				IP54			
Cable	1/2 In. Tap, the flexible cable can be attached (Zinc connector 10 - 16)							

Contact Diagram

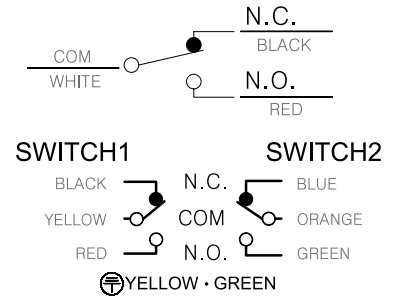

Dimensions

(Unit: mm)



HRF-HD3
201.0 X 115.9 X 141.0

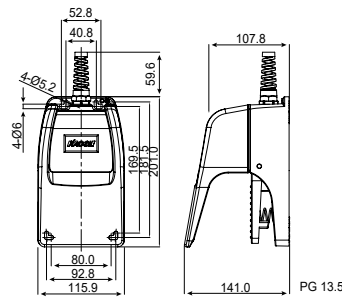

HRF-HD3NS
300.7 X 156.1 X 187.4
(W/Front Cover)

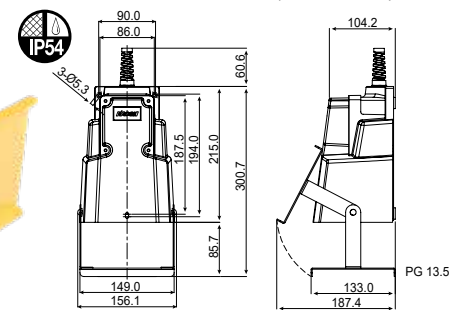

HRF-HD3N
212.0 X 114.8 X 131.5

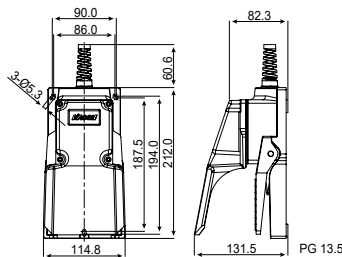

HRF-HD3LX
215.0 X 150.0 X 130.0
Safety Lock Type

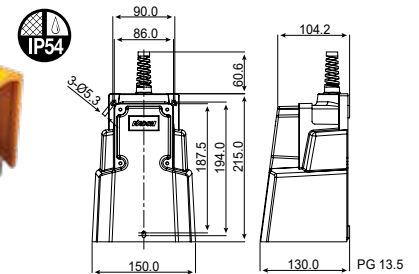

HRF-HD3NX
215.0 X 150.0 X 130.0

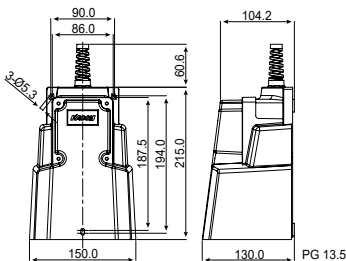

HRF-HD5NX
240.7 X 238.5 X 145.8

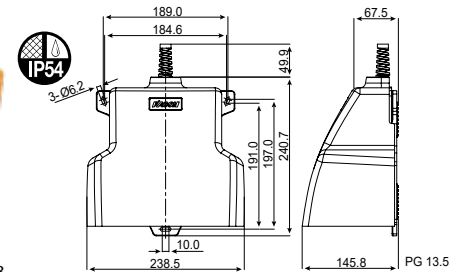

HRF-HD202P
216.0 X 306.0 X 141.3
(CE Only)

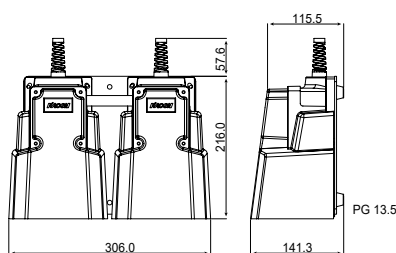

HRF-HD5NS
308.2 X 242.1 X 160.8
(W/Front Cover)

