

# Ring Light

red light, 50 mm

## ZVZF101

Part Number



- Can be mounted together with Smart Camera or Machine Vision Camera
- Continuous mode or strobe mode synchronized with the camera
- Homogeneous and very bright illumination without shadows

wenglor ring lights are ideally suited for uniform illumination. Thanks to 360° annular floodlighting, shadows can be reduced and image quality can thus be improved. They can be operated in continuous mode, or synchronized to the camera in flash mode. The rugged housing with IP67 protection and standardized mounting together with Smart Cameras or Machine Vision Cameras simplify integration into existing systems and generate lots of space for new system concepts.

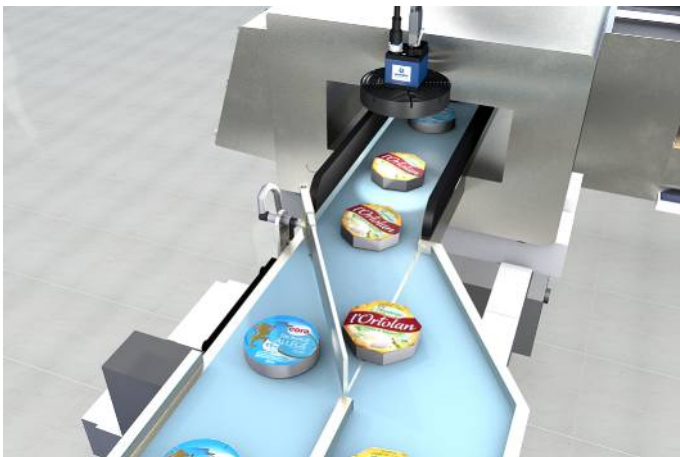

### Technical Data

Optical Data	
Light Source	Red Light
Wavelength	634 nm
Service Life (T = +25 °C)	100000 h
Opening Angle	33 °
Electrical Data	
Supply Voltage	18...30 V DC
Current Consumption Continuous Mode (U <sub>b</sub> = 24 V)	< 760 mA
Current consumption strobe mode (U <sub>b</sub> = 24 V)	< 4100 mA
Flash Duration	17...30000 μs
Duty Cycle	< 0,2
Temperature Range	-30...50 °C
Storage temperature	-30...60 °C
Short Circuit Protection	yes
Reverse Polarity Protection	yes
Overload Protection	yes
Protection Class	III
Mechanical Data	
Housing Material	Aluminum, anodised
Degree of Protection	IP67
Optic Cover	PMMA
Connection	M12 × 1; 4/5-pin
Weight	< 500 g
Safety-relevant Data	
MTTFd (EN ISO 13849-1)	1557,35 a
Connection Diagram No.	181
Connection Table No.	60
Suitable Connection Equipment No.	37
Suitable Mounting Technology No.	470   480

### Complementary Products

Connection cable ZDCG005
ZC4G002 connection cable
ZDCG004 connection cable

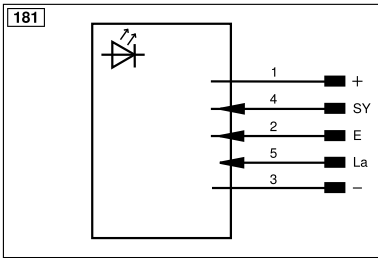
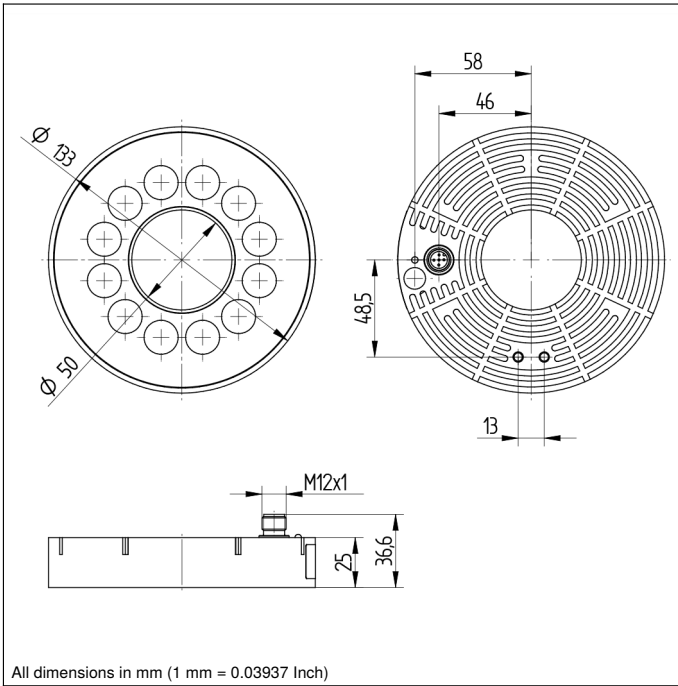



Legend			
+	Supply Voltage +	nc	Not connected
-	Supply Voltage 0 V	U	Test Input
~	Supply Voltage (AC Voltage)	Ü	Test Input inverted
A	Switching Output (NO)	W	Trigger Input
Ā	Switching Output (NC)	W-	Ground for the Trigger Input
V	Contamination/Error Output (NO)	O	Analog Output
ȳ	Contamination/Error Output (NC)	O-	Ground for the Analog Output
E	Input (analog or digital)	BZ	Block Discharge
T	Teach Input	Amv	Valve Output
Z	Time Delay (activation)	a	Valve Control Output +
S	Shielding	b	Valve Control Output 0 V
RxD	Interface Receive Path	SY	Synchronization
TxD	Interface Send Path	SY-	Ground for the Synchronization
RDY	Ready	E+	Receiver-Line
GND	Ground	S+	Emitter-Line
CL	Clock	±	Grounding
E/A	Output/Input programmable	SnR	Switching Distance Reduction
IO-Link	IO-Link	Rx+/-	Ethernet Receive Path
PoE	Power over Ethernet	Tx+/-	Ethernet Send Path
IN	Safety Input	Bus	Interfaces-Bus A(+)/B(-)
OSSD	Safety Output	La	Emitted Light disengageable
Signal	Signal Output	Mag	Magnet activation
BI_D+/-	Ethernet Gigabit bidirect. data line (A-D)	RES	Input confirmation
ENo RS422	Encoder 0-pulse 0/0 (TTL)	EDM	Contact Monitoring
PT	Platinum measuring resistor	ENARs422	Encoder A/Ā (TTL)
		ENBRs422	Encoder B/B̄ (TTL)
		ENA	Encoder A
		ENb	Encoder B
		AMIN	Digital output MIN
		AMAX	Digital output MAX
		Aok	Digital output OK
		SY In	Synchronization In
		SY OUT	Synchronization OUT
		OLT	Brightness output
		M	Maintenance
		rsv	Reserved
		Wire Colors according to DIN IEC 60757	
		BK	Black
		BN	Brown
		RD	Red
		OG	Orange
		YE	Yellow
		GN	Green
		BU	Blue
		VT	Violet
		GY	Grey
		WH	White
		PK	Pink
		GNYE	Green/Yellow

### Light distribution diagram

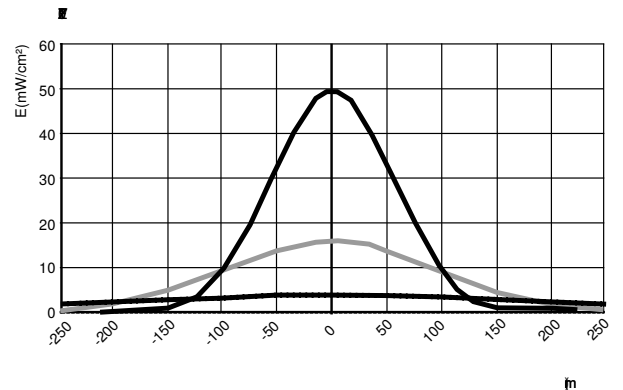
Flash mode, referring to different working distances

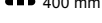

r = Distance to Center Line  
 E = Illuminance

 100 mm  
 200 mm  
 400 mm

