

Protection Column with Protective Screen

Z2SS001

Part Number



- **Effective protection against mechanical damage**
- **Flexible installation: install on the ground or walls**
- **Integrated slot for muting sets**
- **Simple alignment via innovative mounting feature**

The protection column with protective screen provides safety light curtains and multi-light arrays with reliable protection against bumps, collisions and machines. A freestanding setup is possible using the floor mounting of type ZMBSZ0001. The type ZMBSZ0002 wall mounting is suitable for horizontal setups. Axial or vertical alignment is possible with just a few turns of your hand thanks to the intelligent mounting technology and integrated level. One slot on the protection column simplifies installation and alignment of the various muting sets.

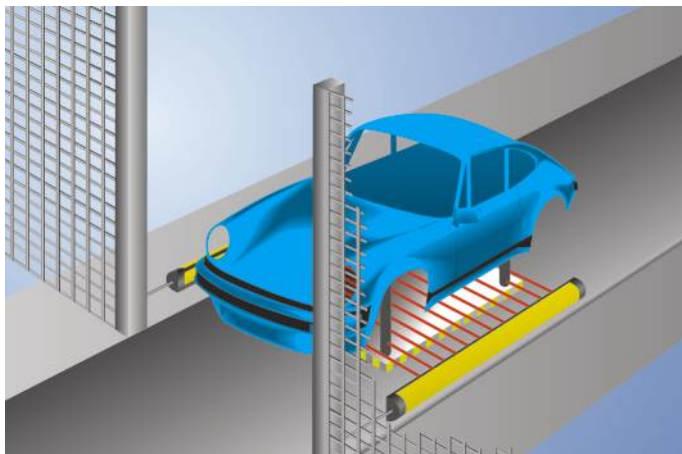

Technical Data

Optical Data

Safety Field Height (SFH) 930 mm

Mechanical Data

Housing Material Aluminum

Disc Material Polycarbonate

Cable Outlet bottom/top

Mounting Space (EBR) 1252 mm

Suitable Mounting Technology No. **710 770 780**

Mounting Bracket, Floor or Wall Mounting are required for mounting (not included in delivery)

Complementary Products

Floor Mounting ZMBSZ0001

Mounting Bracket BEF-SET-36

Mounting Bracket ZEMX002

Wall Mounting ZMBSZ0002

