

Safety Light Curtain

Finger Protection

SEMG532



- Easy configuration via wiring
- Protection field over the entire length of the housing for an installation without protrusion
- Quick alignment through visible red light
- Slim design for easy integration

These safety light curtains complete all basic tasks with ease. The basic functions of safety operating mode, restart inhibit and contactor monitoring are integrated as standard and can be easily configured. Without protrusion, the safety field always extends to the end of the housing. This makes it easy to secure even in confined installation conditions.

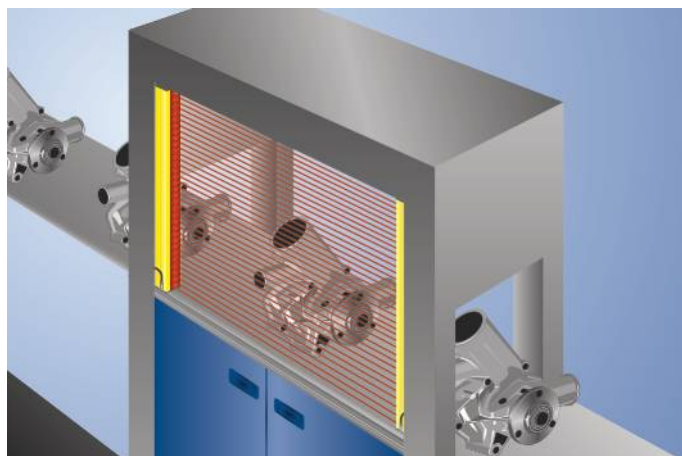

Optical Data	
Range	0,25...6 m
Housing Length (L)	309 mm
Safety Field Height (SFH)	310 mm
Resolution	14 mm
Light Source	Red Light
Wavelength	630 nm
Opening Angle	± 2,5 °

Electrical Data	
Sensor Type	Emitter
Supply Voltage	19,2...28,8 V DC
Current Consumption (U _b = 24 V)	75 mA
Temperature Range	-25...55 °C
Storage temperature	-25...60 °C
Reverse Polarity Protection	yes
Protection Class	III

Mechanical Data	
Housing Material	Aluminum
Disc Material	Polycarbonate
Degree of Protection	IP65/IP67
Connection	M12 × 1; 4/5-pin
Cable Length	300 mm

Safety-relevant Data	
ESPE Type (EN 61496)	4
Performance Level (EN ISO 13849-1)	Cat. 4 PL e
Mission Time TM (EN ISO 13849-1)	20 a
Safety Integrity Level (EN 61508)	SIL3
Safety Integrity Level (EN 62061)	SILCL3

Function	
Finger Protection	yes
Scope of functions	Basic function

Connection Diagram No.	362
Control Panel No.	SR4
Suitable Connection Equipment No.	2 35
Suitable Mounting Technology No.	701 790 810 820

Suitable Receiver

SEMG632

Complementary Products

Path-Folding Mirror Z2UG002
Protection Column with Path-Folding Mirror SZ000EU125NN01
Protection Column with Protective Screen SZ000EG125NN01
Protection column with protective screen Z2SS001
Protection column with Z2SU001 deflection mirror
Software

Ctrl. Panel

SR4

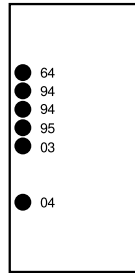
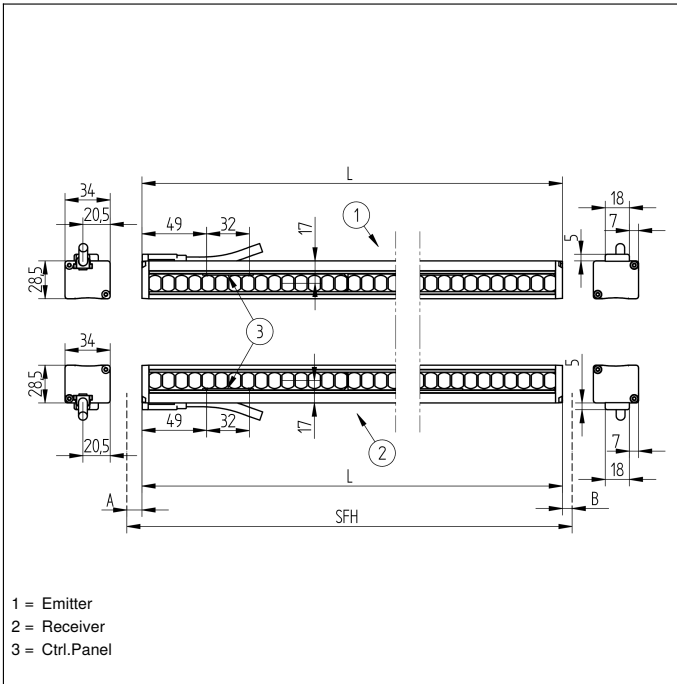

03 = Error Indicator
 04 = Function Indicator
 64 = Diagnosis/Test
 94 = Diagnosis
 95 = Diagnosis/Large Detection Range

