

2D/3D Profile Sensor

MLWL225

LASER

weCat3D

Part Number

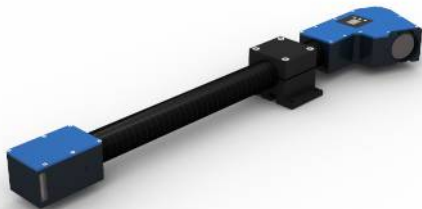

- Optimized profile quality thanks to HDR function
- Precise measuring range resolution X (> 2000 measuring points)
- Up to 12 million measuring points per second

2D/3D Profile Sensors project a laser line onto the object to be detected and generate an accurate, linearized height profile with an internal camera which is set up at a triangulation angle. Thanks to its uniform, open interface, the weCat3D series can be incorporated by means of the DLL program library or the GigE Vision standard without an additional control unit. Alternatively, wenglor offers its own software packages for implementing your application.

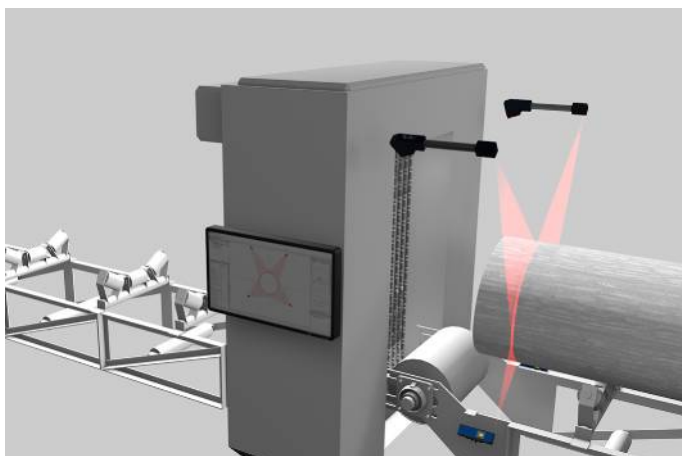

Technical Data

Optical Data	
Working range Z	1000...2500 mm
Measuring range Z	1500 mm
Measuring range X	850...1300 mm
Linearity Deviation	375 µm
Resolution Z	92...439 µm
Resolution X	505...1095 µm
Light Source	Laser (red)
Wavelength	660 nm
Laser Class (EN 60825-1)	2M

Environmental conditions	
Ambient temperature	0...45 °C
Storage temperature	-20...70 °C
Max. Ambient Light	5000 Lux
EMC	DIN EN 61000-6-2; 61000-6-4
Shock resistance per DIN IEC 68-2-27	30 g / 11 ms
Vibration resistance per DIN IEC 60068-2-6	6 g (10...55 Hz)

Electrical Data	
Supply Voltage	18...30 V DC
Current Consumption (U _b = 24 V)	300 mA
Measuring Rate	175...6000 /s
Subsampling	350...6000 /s
Inputs/Outputs	4
Switching Output Voltage Drop	< 1,5 V
Switching Output/Switching Current	100 mA
Short Circuit Protection	yes
Reverse Polarity Protection	yes
Overload Protection	yes
Interface	Ethernet TCP/IP
Baud Rate	100/1000 Mbit/s
Protection Class	III
FDA Accession Number	1710274-000

Mechanical Data	
Housing Material	Aluminum
Degree of Protection	IP67
Connection	M12 × 1; 12-pin
Type of Connection Ethernet	M12 × 1; 8-pin, X-cod.
Optic Cover	Glass
Weight	2620 g

Web server	yes
------------	-----

Push-Pull	<input checked="" type="checkbox"/>
-----------	-------------------------------------

Connection Diagram No.	1022	1034
------------------------	------	------

Control Panel No.	X2	A22
-------------------	----	-----

Suitable Connection Equipment No.	50	87
-----------------------------------	----	----

Complementary Products

Connection cables
Control Unit
Cooling Unit ZLWK003
Protective Screen Retainer ZLWS003
Software
Switch EHSS001

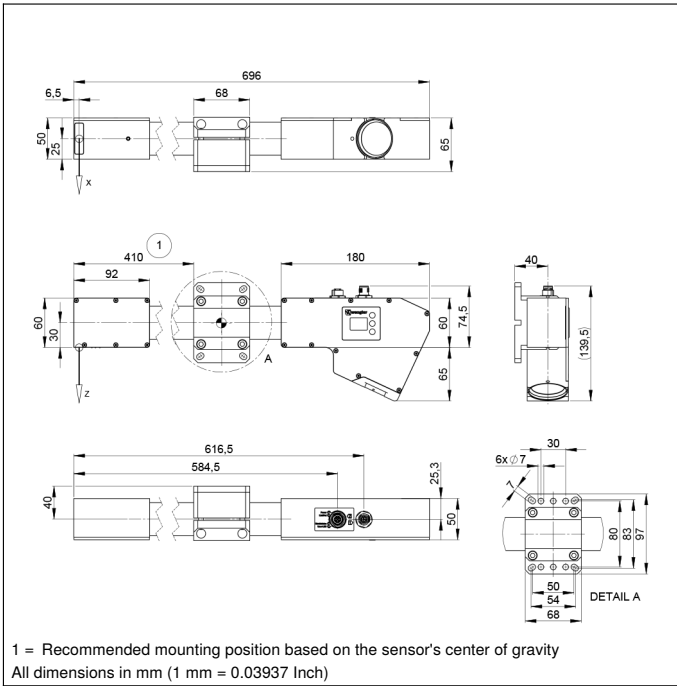

Ctrl. Panel

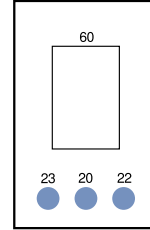
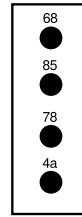
A22
X2

- 20 = Enter key
- 22 = Up key
- 23 = Down key
- 4a = User LED
- 60 = display
- 68 = supply voltage indicator
- 78 = Module status
- 85 = Link/Act LED

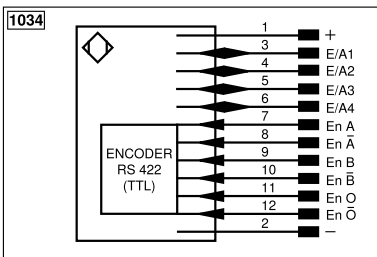
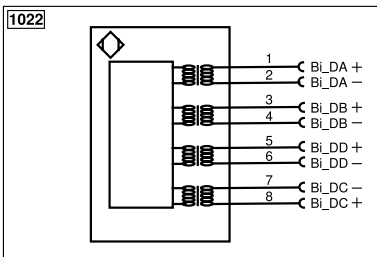

Legend					
+	Supply Voltage +	nc	Not connected	EN _{BRS422}	Encoder B/B̄ (TTL)
-	Supply Voltage 0 V	U	Test Input	ENA	Encoder A
~	Supply Voltage (AC Voltage)	Ü	Test Input inverted	ENb	Encoder B
A	Switching Output (NO)	W	Trigger Input	AMIN	Digital output MIN
Ā	Switching Output (NC)	W-	Ground for the Trigger Input	AMAX	Digital output MAX
V	Contamination/Error Output (NO)	O	Analog Output	Aok	Digital output OK
V̄	Contamination/Error Output (NC)	O-	Ground for the Analog Output	SY In	Synchronization In
E	Input (analog or digital)	BZ	Block Discharge	SY OUT	Synchronization OUT
T	Teach Input	Amv	Valve Output	OLT	Brightness output
Z	Time Delay (activation)	a	Valve Control Output +	M	Maintenance
S	Shielding	b	Valve Control Output 0 V	rsv	Reserved
RxD	Interface Receive Path	SY	Synchronization	Wire Colors according to DIN IEC 60757	
TxD	Interface Send Path	SY-	Ground for the Synchronization	BK	Black
RDY	Ready	E+	Receiver-Line	BN	Brown
GND	Ground	S+	Emitter-Line	RD	Red
CL	Clock	±	Grounding	OG	Orange
E/A	Output/Input programmable	SnR	Switching Distance Reduction	YE	Yellow
⚡	IO-Link	Rx+/-	Ethernet Receive Path	GN	Green
PoE	Power over Ethernet	Tx+/-	Ethernet Send Path	BU	Blue
IN	Safety Input	Bus	Interfaces-Bus A(+)/B(-)	VT	Violet
OSSD	Safety Output	La	Emitted Light disengageable	GY	Grey
Signal	Signal Output	Mag	Magnet activation	WH	White
BI_D+/-	Ethernet Gigabit bidirect. data line (A-D)	RES	Input confirmation	PK	Pink
EN _o RS422	Encoder 0-pulse 0/0̄ (TTL)	EDM	Contact Monitoring	GNYE	Green/Yellow
PT	Platinum measuring resistor	EN _{A_{RS422}}	Encoder A/Ā (TTL)		

Measuring field X, Z

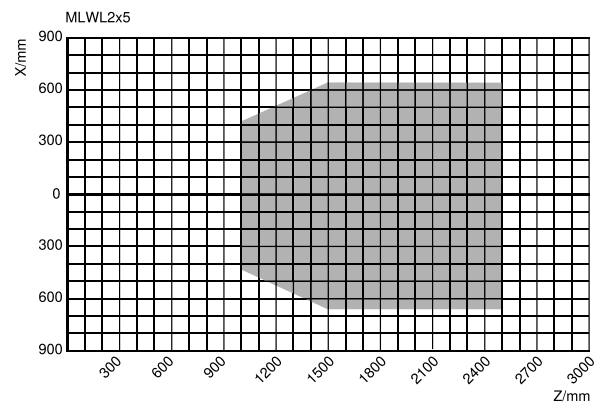

Z = Working distance
 X = Measuring Range

