

Barcode Raster Scanner

FIS-0830-1102 LASER

Part Number

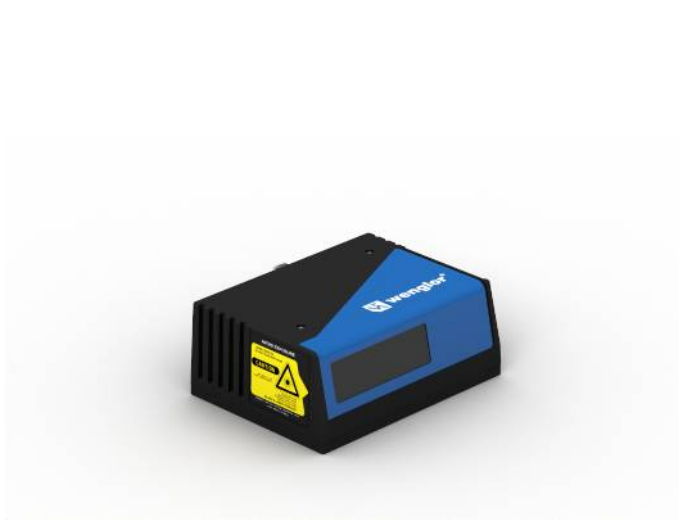

- Adaptable 90° mirror
- Adjustable scanning width
- Diagnosis functions
- Ethernet TCP/IP and EtherNet/IP™
- Integrated code reconstruction

This barcode scanner is suitable for reading very high density barcodes. The adjustable scanning width allows for ideal adaptation to your application. The following code types can be processed: Code39, Code93, Interleaved 2 of 5, Code128, Codabar, UPC, PDF417, Micro PDF417, UCC/EAN-128, AIAG, GS1 Databar, Pharmacode.

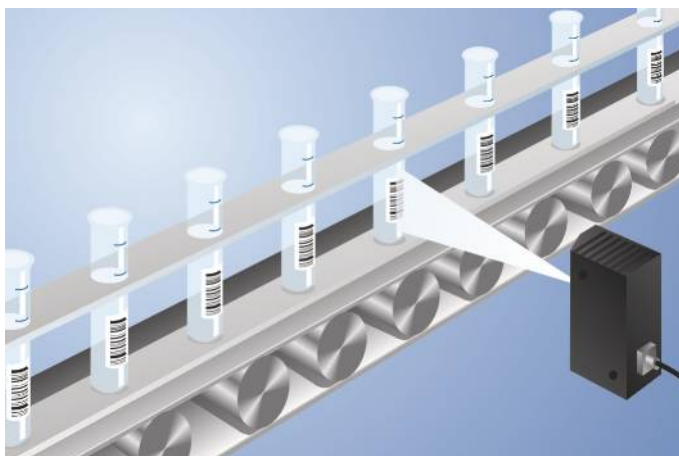

Technical Data

Optical Data	
Barcode Density	High density
Deflection Angle	2 °
Number of Raster Scan Lines	10
Read Range	82...228 mm
Light Source	Laser (red)
Wavelength	655 nm
Service Life (T = +25 °C)	50000 h
Laser Class (EN 60825-1)	2
Max. Ambient Light	4840 Lux
Opening Angle	60 °
Adjustable Scan Width	yes
Barcode Printing Contrast	> 25 %
Electrical Data	
Supply Voltage	10...28 V DC
Power Consumption	4320 mW
Scan Rate	300...1400 scans/sec
On-/Off-Delay (RS-232)	0...2,55 s
Temperature Range	0...50 °C
Switching Output	Optoisolator
Number of Switching Outputs	3
Switching Output/Switching Current	100 mA
Reverse Polarity Protection	yes
Network Possibilities	Daisy Chain, Multidrop
Interface	RS-232
Baud Rate	< 100 MBd
Trigger Input	Optoisolator
Signal Input	Optoisolator
Number of Signal Inputs	2
Acoustic signal	yes
Protection Class	III
FDA Accession Number	8310057-012
Mechanical Data	
Housing Material	Aluminum
Optic Cover	Glass
Weight	212 g
Degree of Protection	IP54
Connection	M12 × 1; 12-pin
Type of Connection Ethernet	M12 × 1; 8-pin
PNP NO/NC switchable	●
NPN NO/NC switchable	●
RS-232 Interface	●
Ethernet	●
EtherNet/IP™	●
Connection Table No.	39
Control Panel No.	F12
Suitable Connection Equipment No.	12 13
Suitable Mounting Technology No.	440 330

Complementary Products

Connection Box ZAA12NN01
Connection Cable ZAV88Rx01
Fieldbus Gateway ZAGxxxN01, EPGG001
Path-Folding Mirror LA19
Power Supply Unit NT10
Software

Ctrl. Panel

Fi2

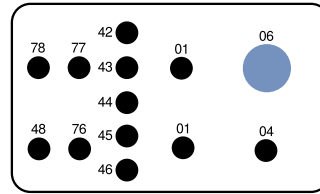

- 01 = Switching Status Indicator
- 04 = Function Indicator
- 06 = Teach Button
- 42 = Reading Performance 100 %/Good Read
- 43 = Reading Performance 80 %/Status/Trigger
- 44 = Reading Performance 60 %
- 45 = Reading Performance 40 %
- 46 = Reading Performance 20 %
- 48 = Network Status
- 76 = Network Tx enabled
- 77 = Network Rx enabled
- 78 = Module status

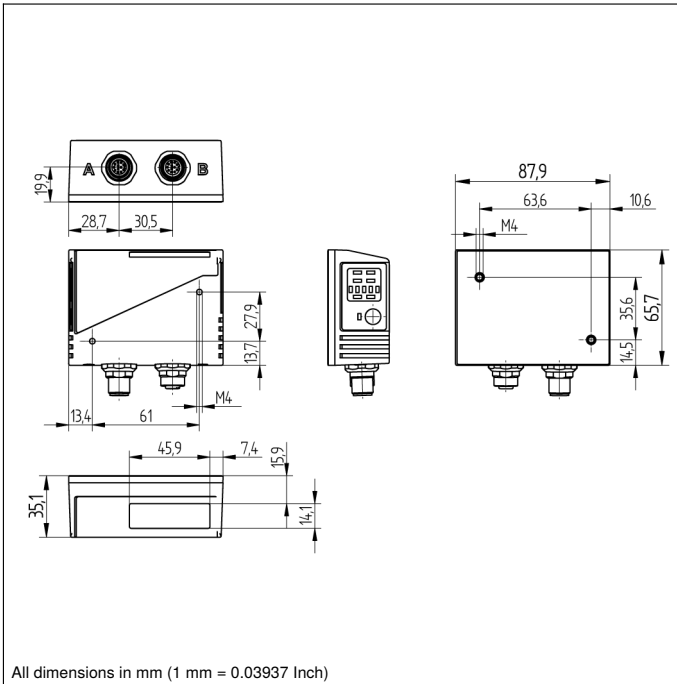

All dimensions in mm (1 mm = 0.03937 Inch)

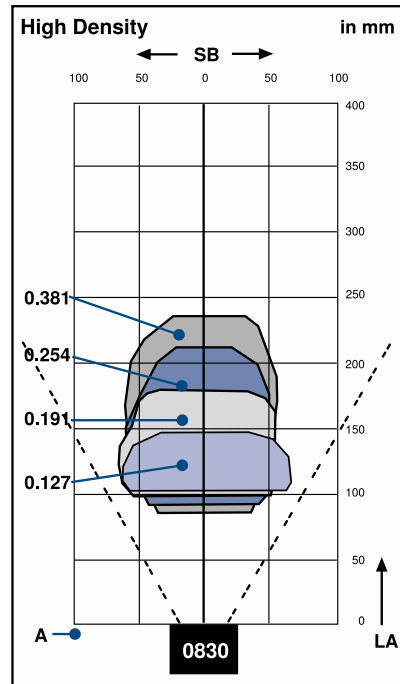
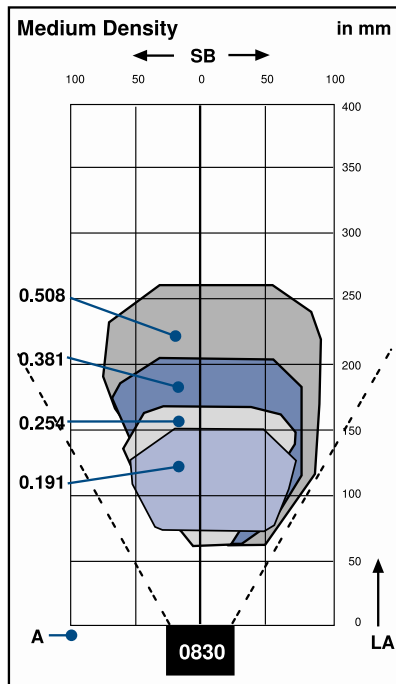
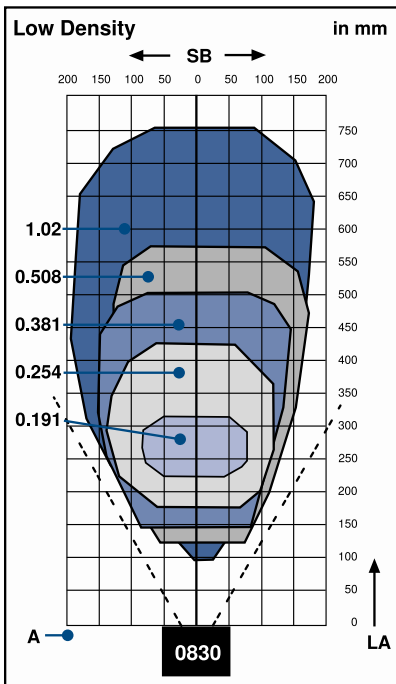

A = Resolution LA = Read Range SB = Scan Width

