

1D/2D Code Scanner

C5PC100

Part Number

IndustrialEthernet



- Auto-button function
- Integrated code reconstruction
- Integrated LED illumination
- PROFINET and EtherNet/IP™
- Web link

These 2D code scanners are suitable for omnidirectional scanning of 1D and 2D codes.

The following code types can be processed:

1D codes: Code39, Code93, Code128, UPC/EAN, BC412, Interleaved 2 of 5, Codabar, Postal Codes, Pharmacode

2D codes: DataMatrix ECC 0...200, PDF417, Micro PDF417, QR-Code, Micro QR-Code, Aztec Code, GS1 Databar, Dot code

Additional code types upon request.

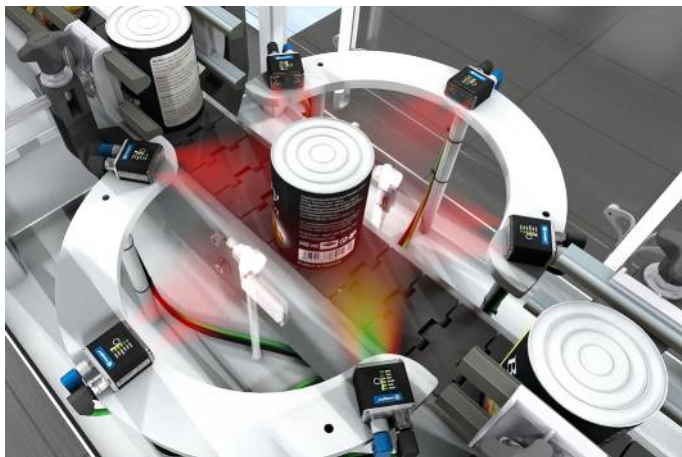

Technical Data

Optical Data	
Barcode Density	Standard density
Read Range	50 mm
Resolution	752 × 480 Pixel
Light Source	Red Light
Wavelength	617 nm
Focus	Fix
X-Dimension	49 mm
Y-Dimension	32 mm
min. Resolution	> 0,191 mm
Electrical Data	
Supply Voltage	5...30 V DC
Current Consumption (U _b = 24 V)	180 mA
Scan Rate	60 scans/sec
Temperature Range	0...45 °C
Switching Output	Optoisolator
Number of Switching Outputs	3
Switching Output/Switching Current	< 100 mA
Reverse Polarity Protection	yes
Interface	RS-232/Ethernet
Trigger Input	Optoisolator
Signal Input	Optoisolator
Number of Signal Inputs	3
Mechanical Data	
Setting Method	Ethernet
Housing Material	Metal
Weight	68 g
Degree of Protection	IP65/IP67
Connection	M12 × 1; 12-pin
Type of Connection Ethernet	M12 × 1; 8-pin
PNP NO/NC switchable	●
NPN NO/NC switchable	●
Ethernet	●
PROFINET-I/O, CC-B	●
EtherNet/IP™	●
Connection Table No.	39
Control Panel No.	A24
Suitable Connection Equipment No.	87
Suitable Mounting Technology No.	430

Complementary Products

Connection Cable ZCYV00x
Connection cable ZDCG005
Path-Folding Mirror ZNNG028
Protective Housing ZSV-0x-01
Software
ZC4G002 connection cable
ZC4G003 connection cable
ZNNG053 Replacement disc
ZNNG054 Optical diffuser
ZNNG055 Polarization filter
ZNNG056 ESD protective screen
ZNNG057 YAG filter

Ctrl. Panel

A24

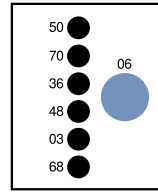

- 03 = Error Indicator
- 06 = Teach Button
- 36 = Mode Indicator
- 48 = Network Status
- 50 = Good Read
- 68 = supply voltage indicator
- 70 = Run/Trigger

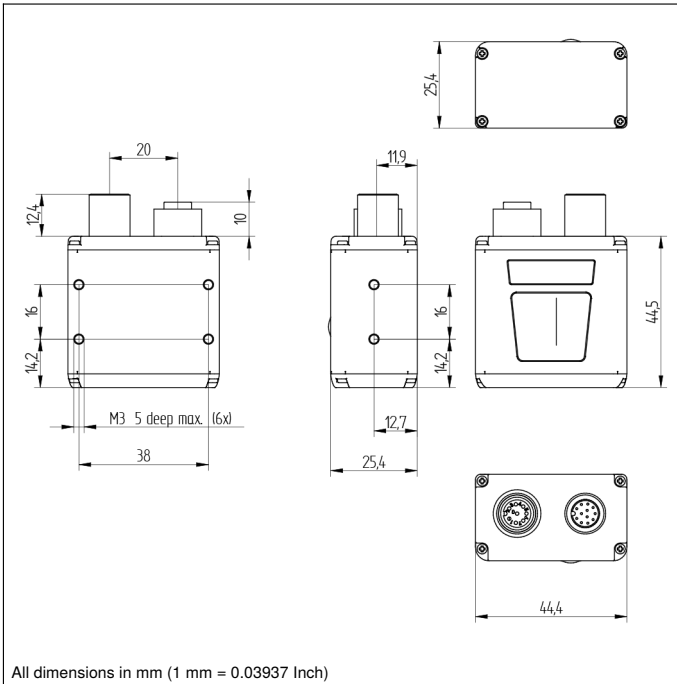

All dimensions in mm (1 mm = 0.03937 Inch)

