



SMART SENSORS

MEASURE MONITOR CONFIGURE PREDICT



✓ Multi-Mode High-Resolution Measurement



✓ Embedded Predictive-Maintenance Features

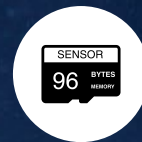

✓ User-Defined Memory



✓ User-Configurable Outputs



✓ Direct Device-to-Device Communication



✓ Dual Channel

SMART SENSORS

UNLOCK NEW SENSING POTENTIAL

Contrinex Smart Sensors, designed with the needs of OEMs and system integrators in mind, have all the answers when it comes to reducing complexity and cost. By implementing multiple sensing modes in a single sensor, Contrinex has given designers the freedom they've always dreamed about, offering exceptional versatility and simplified integration. Let Contrinex Smart Sensors supercharge your IoT strategy; enjoy all the advantages of the industry-standard IO-Link SSP 3.3 interface, plus the option of high-speed sensor-based decision-making using SIO. The only limit is your imagination...



PRODUCT ADVANTAGES

- ✓ Multiple sensing modes in a single sensor:
 - Direct measurement: distance measurement, lateral position measurement (constant distance), feature detection
 - Indirect measurement: angular measurement, lateral position measurement (inclined plane), force measurement, vibration measurement, step counting
- ✓ Exceptional versatility optimizes spares inventory
- ✓ Condition-based self-monitoring minimizes maintenance costs
- ✓ Localized D2D process logic enables sensor-based decision-making
- ✓ Unique embedded sensor ID eliminates installation errors
- ✓ IO-Link smart profile simplifies control-system integration



INDUSTRIES

- Automation
- Packaging
- Robotics
- Automotive
- Green Energy
- Environment
- Logistics
- Machine Tools
- Electronic Assembly
- Food & Beverage
- Textiles
- Materials Handling

SMART FEATURES



MULTI-MODE HIGH-RESOLUTION MEASUREMENT

- ✓ **Multiple sensing modes in a single sensor**

DIRECT AND INDIRECT MEASUREMENT

By adopting both direct and indirect measurement techniques, Contrinex has implemented multiple sensing modes in a single Smart Sensor. Depending on the user-defined mode of operation, measurements may be output as either process data (routine, cyclical parametric values) or event data (exceptions generated on the occurrence of a critical event).

Using the Smart Sensor's underlying capability for high-resolution distance measurement, direct measurements include axial distance (1) and lateral position (2). The sensor's exceptional sensitivity also allows it to detect non-uniform features (for example, holes) present in a target (4).

Other physical properties whose application can be translated into a displacement are also suitable for Smart Sensing. Non-contact examples include: continuous angular measurement using a cam mounted on a rotating shaft (3), lateral position measurements of larger targets using an inclined plane surface on the target (5), force measurement using a transfer element that deforms elastically (6), as well as vibration measurement (amplitude and frequency) in the axial direction (7).

Step counting – either linear or rotational (8) – is another proven application for Smart Sensors. The sensitivity of these devices allows them to replace traditional encoders, which are often bulkier and more costly.

1. Distance measurement

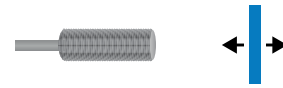

2. Lateral position measurement (constant distance)

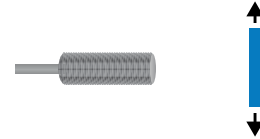

3. Angular measurement

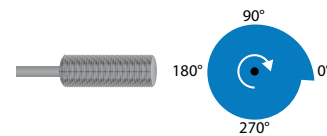

4. Feature detection

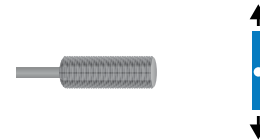

5. Lateral position measurement (inclined plane)

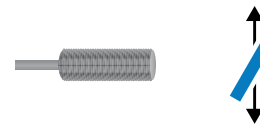

6. Force measurement

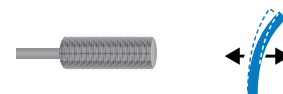

7. Vibration measurement

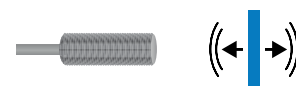

8. Step counting

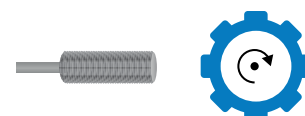



USER CONFIGURABLE OUTPUTS

✓ Exceptional versatility optimizes spares inventory

SWITCHING SIGNAL CHANNELS (SSC)

The Smart Sensor's internal signals are referred to as Switching Signal Channels (SSC); the external input and output signals that result from an SSC are designated Output Switching Signals (OSS). By default, a Smart Sensor has a single-point threshold SSC enabled on Pin 4 (OSS1) of its connector, which operates in either IO-Link mode or Standard-IO (SIO) mode. On power-up, a Smart Sensor defaults to SIO mode; once the sensor is connected to an IO-Link master, a "wake-up" pulse from the master switches it to IO-Link mode. Thereafter, bidirectional communication operates between the master and the sensor.

PIN ASSIGNMENT

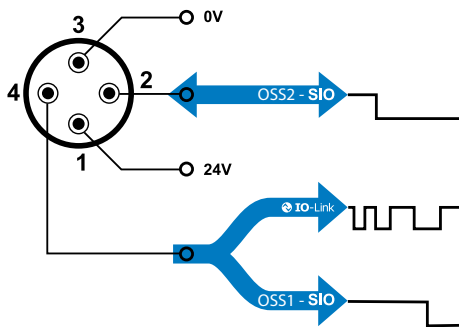

A second SSC may optionally be configured on Pin 2 (OSS2) of the Smart Sensor connector. If enabled, SSC2 operates solely in SIO mode and may be designated as an input or an output channel. The presence of a second IO channel gives integrators access to powerful additional features of the Smart Sensor, including Device-to-Device communication, Teach functions and Built-in Test functions.

DYNAMIC SWITCHING LOGIC

When specifying Contrinex Smart Sensors, designers assign their chosen switching logic to any of the available sensing modes – either as a one-time choice at the time of installation, or dynamically as the equipment operating sequence dictates. A single sensor provides all the options needed to monitor multiple parameters, with the flexibility to make real-time changes over IO-Link or via the built-in Teach function.

SINGLE-POINT MODE

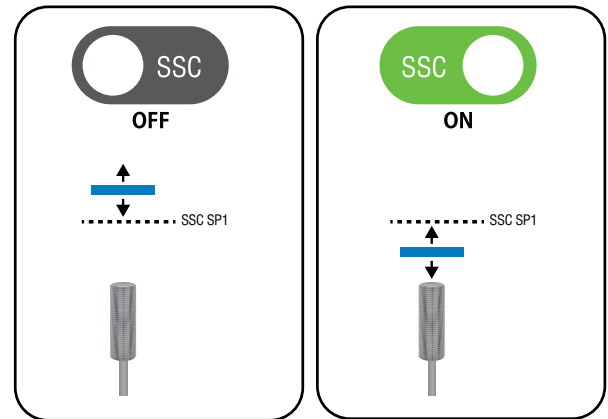

With single-point mode selected, Smart Sensors behave as conventional two-state devices. The default logic (which may be inverted if the application requires it) sets the switching signal to "high" (SSC ON), if a threshold level or setpoint (target sensing distance, for example) has been reached. Either side of the switching point, the signal simply switches between "high" and "low" accordingly.

WINDOW MODE

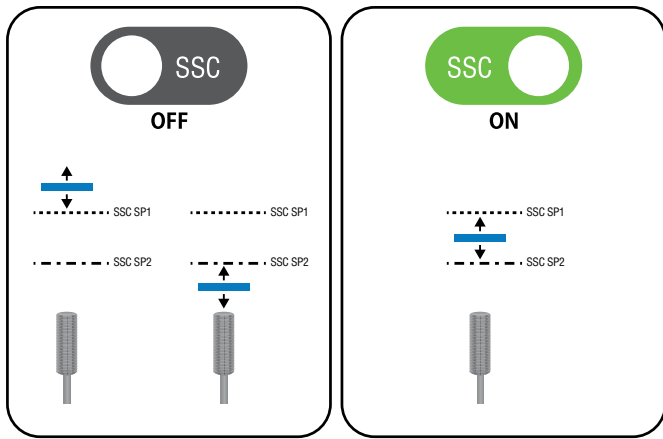

Window mode allows designers to monitor a range of values, which may be defined by two discrete switching setpoints. As the example shows, the default logic sets the switching signal to “high” (SSC ON) if the measured value lies between the two setpoints. In all other cases, once the measured value moves outside the defined range, the switching signal is set to “low”.

TWO-POINT (HYSTERESIS) MODE

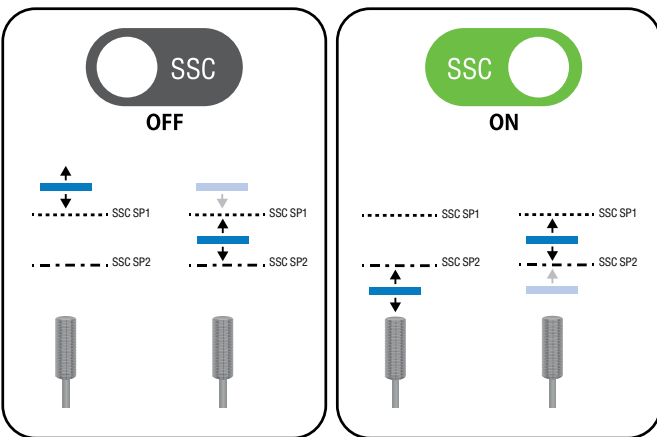

Two-point (hysteresis) mode showcases the Smart Sensor’s ability to respond to setpoints or threshold values that trigger a change in the SSC only when the measured value is moving in a specified direction (rising or falling). In the example shown, as the measured value falls and passes SP1, the SSC remains set to “low” (SSC OFF). Only when the measured value reaches SP2 is the SSC set to “high”. As the measured value rises again, passing SP2 has no effect on the SSC, which is only set to “low” once the measured value reaches SP1 again.

TIMING MODES

Modifying the timing of a change in the SSC allows designers to nullify the effect of common process events that give rise to false triggers. Such events include (i) momentary changes in measurement value for non-process-related reasons and (ii) momentary loss of signal for known reasons.

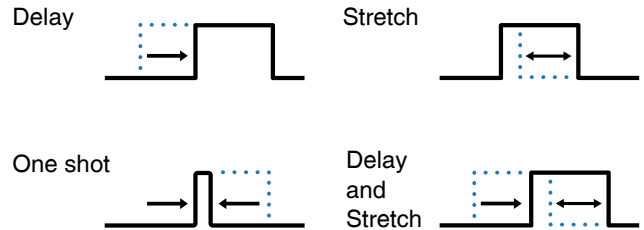

DELAY

Introducing a specified delay before changing the status of the OSS in either direction prevents the sensor responding to a short-duration change in measurement value for reasons that include localized variability in the environment. Adopting a switching delay also helps prevent signal “bounce”, where the transition from one state to another may not be clearly defined. Delay may optionally be combined with stretch (see below).

STRETCH

Stretching the OSS output pulse ensures that the signal has a minimum duration – often desirable for control purposes or to compensate for a measurement value that varies non-linearly over time. For example, communication with a “slow” PLC may require a minimum-duration pulse to ensure proper synchronization. Similarly, in the absence of a minimum-duration pulse, a measurement value that is not clearly defined during the transition from one state to another might otherwise give rise to multiple false triggers.

ONE-SHOT MODE

Smart Sensors also have the capability to generate a “one-shot” pulse on either the leading edge or the trailing edge of a change in the measurement value. One-shot pulses, also known as “differential up” and “differential down” may be required for secondary control functions that are implemented in a connected PLC.

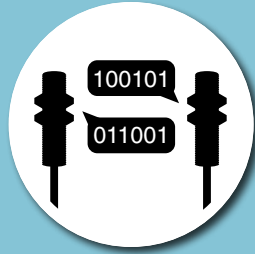

DIRECT DEVICE-TO-DEVICE COMMUNICATION

✓ Localized D2D process logic enables sensor-based decision-making

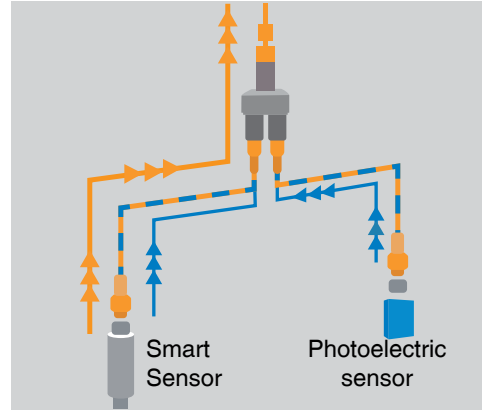
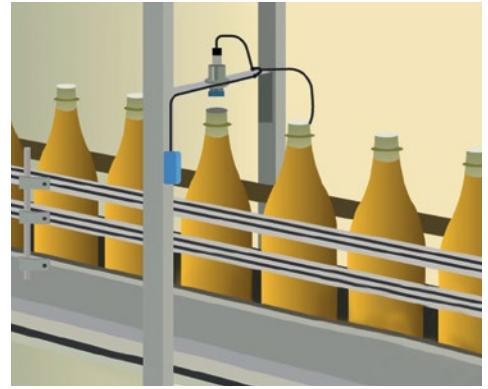

BOOLEAN LOGIC

Designating a second SSC as an input channel allows designers to implement Boolean logic by combining an internal switching signal of the Smart Sensor (SSC1) together with that of a second two-state sensor (OSS2) operating in SIO mode. In the example shown, the Smart Sensor monitors the presence of an aluminum-foil closure on a bottle, while the secondary photoelectric sensor checks the fill level.

BOOLEAN AND (sensor enable/disable on pin 2)

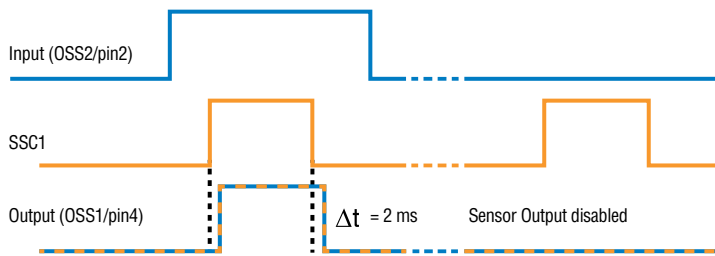

BOOLEAN "AND"

Operating in Boolean "AND" mode, the signal from the secondary sensor is used to enable or disable the Smart Sensor, resulting in the Smart Sensor output (OSS1) being set to "high" only when both sensors are triggered. The output signal on OSS1 is delayed by two milliseconds.

BOOLEAN OR (sensor bypass on pin 2)

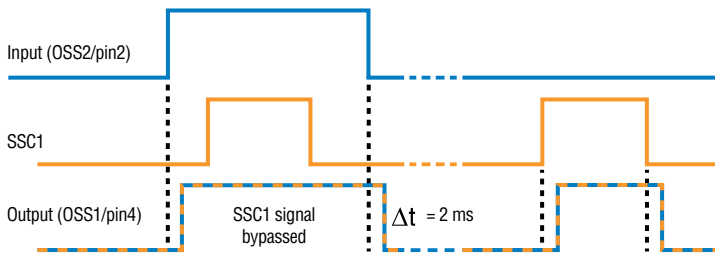

BOOLEAN "OR"

Alternatively, when a Boolean "OR" function is required, a "high" signal from the secondary sensor is set to bypass the Smart Sensor signal, overwriting the SSC1 output. The Smart Sensor otherwise continues to operate normally, and consequently, its output (OSS1) is set to "high" when either sensor is triggered. Again, a two-millisecond delay is introduced.

BUILT-IN TEST (BITE) FUNCTION

The SSC2 input channel serves an additional purpose when a self-test function is required. A BITE signal on SSC2 from a connected PLC or microcontroller is used (i) to determine whether the Smart Sensor is functioning correctly and (ii) to establish the presence or absence of a target.

A BITE handshake pulse returned by the sensor confirms its working state, while the polarity of the pulse indicates the presence or absence of a target. Failure by the sensor to return a handshake pulse signifies a defective device.

BOOLEAN XOR (BITE function on pin 2)

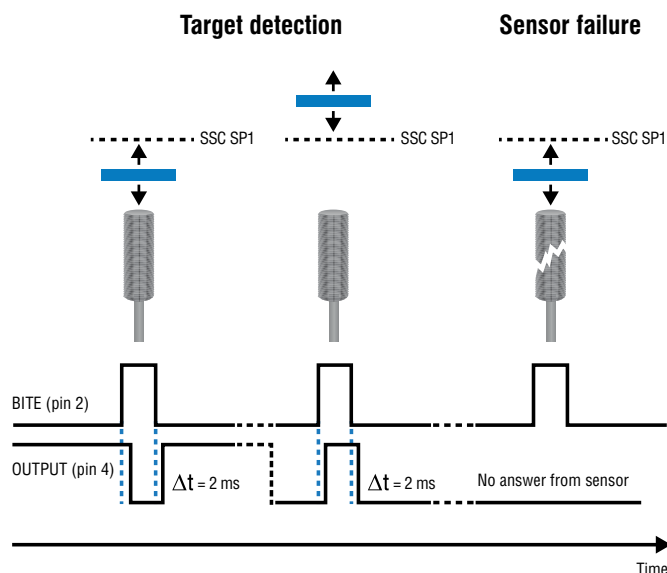

TEACH FUNCTION

Teaching the sensor externally to recognize one or more setpoints is another D2D function. Smart Sensors are supplied with default (factory-set) values for SP1 and SP2; during commissioning, engineers use either a locally connected teach device or a remote PLC to communicate with the Smart Sensor via OSS2.

EXTERNAL TEACH (high/low signal on pin 2)

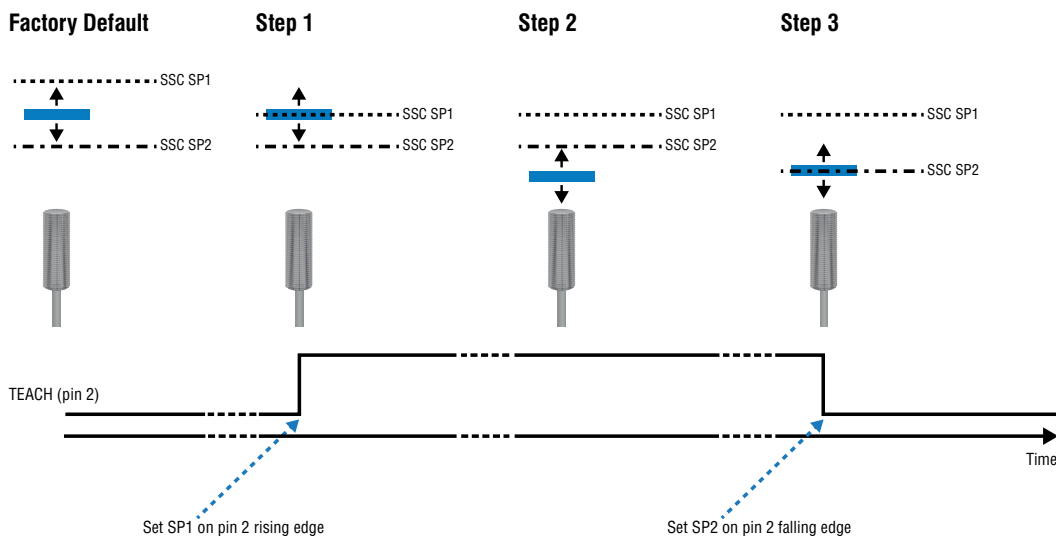

Positioning the target at the first setpoint and triggering the teach pulse sets SP1 on the rising edge of the pulse. Repositioning the target to the second setpoint and removing the teach pulse then sets SP2 on the falling edge of the pulse.

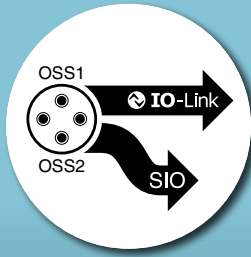

DUAL CHANNEL

- ✓ IO-Link smart profile simplifies control-system integration
- ✓ High-speed sensor-based decision-making using SIO

LOCALIZED HIGH-SPEED CONTROL

Enabling OSS2 on Pin 2 of the Smart Sensor connector gives system integrators access to localized high-speed control options; as already noted, OSS2 operates solely in SIO mode and may be designated as an input or an output channel. In addition to D2D communication, two specific advantages stand out.

REPORTING TIME-CRITICAL EVENTS

Should a remote sensor identify an out-of-range parameter that requires immediate intervention, (for example, overheating), an event-based output signal is generated to notify the central control system – in the example shown, a PLC – that a system-wide shut-down is essential. In this instance, the IO-Link output (OSS1) may not respond quickly enough to prevent the problem escalating.

Using the SIO output on OSS2, the sensor delivers a high-speed notification directly to the PLC, bypassing the IO-Link channel and initiating the shut-down sequence immediately. The Smart Sensor’s dual-channel capability ensures that further, costly damage is avoided and that subsequent process down-time is minimized.

DECENTRALIZED CONTROL

Smart Sensors are also ideally suited to non-critical, decentralized process tasks under local control. In the example shown, a local SIO input signal on OSS2 enables or inhibits the operation of the sensor without the need to route the command via the PLC. This configuration consumes little or no system-wide resource, requiring only a confirmatory IO-Link signal on OSS1 to update the sensor status in due course.

With OSS2 signal alternatively configured in output mode, the Smart Sensor may, for example, control the operation of a local sub-system, again without the need to route the command via the PLC. Using the signal to switch a simple two-state device allows the sensor to control the operation of any associated non-intelligent equipment, for example an actuator or an electrical circuit.

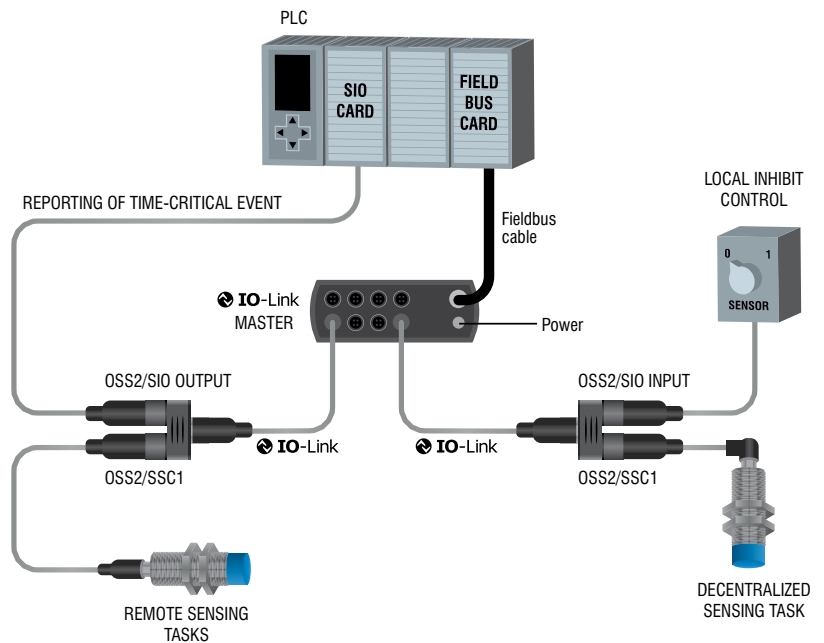



PREDICTIVE MAINTENANCE FEATURES

- ✓ **Condition-based self-monitoring minimizes maintenance costs**
- ✓ **Plug-and-play sensor replacement**

SAVING TIME BY DESIGN

In a fast-moving process-manufacturing environment, down-time is a major cost factor. While some interruptions to production are inevitable, minimizing lost time is a priority, and Smart Sensors offer big benefits here, saving time by design.

PLUG-AND-PLAY REPLACEMENT

Once initial commissioning is completed, each sensor's configuration is stored automatically on the local IO-Link Master; this allows plug-and-play replacement of sensors should the need arise, without any loss of functionality and without any need for recalibration. Down-time and the associated maintenance cost is kept to a minimum.

CYCLICAL AND EVENT-BASED REPORTING

The Smart Sensor's predictive-maintenance capabilities rely on its ability to collect both process data and event data, as well as making use of its on-board cumulative-data stores. Not only can maintenance engineers monitor long-term equipment behavior, they also have confidence in the sensor's ability to flag any one-off threshold exceptions that require attention.

THRESHOLD EXCEPTIONS

The sensor's records cumulative data for distance, cycle count and temperature, with alarm thresholds set for each. Cumulative cycle-count limits for the expected life of the equipment being monitored are programmed into the sensor memory, and a threshold alarm is triggered when the set value is exceeded, typically via IO-Link, although a high-speed SIO output may be used instead.

In the case of distance and temperature, a single, ultimate limit for each parameter is set, and any measurement that exceeds either limit is sufficient to trigger an alarm; in this instance, a high-speed SIO signal is almost certainly the preferred option. Cumulative temperature measurements may also trigger a parametric-shift alarm, as explained below.

Distance

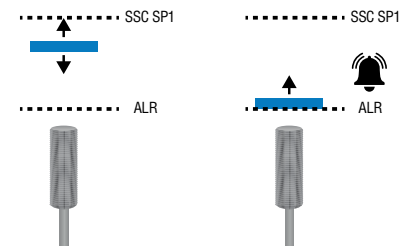

Counter



Temperature

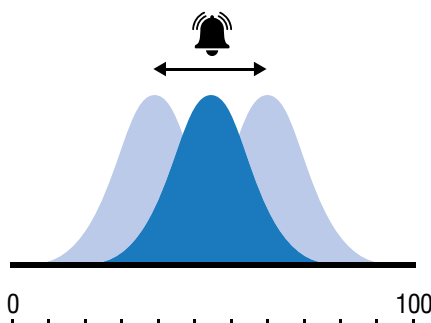

PARAMETRIC SHIFT

Stored measurements from a prolonged period of operation provide maintenance engineers with a pattern of data over time; typically, the data will form a normal distribution centered around the expected mean value for the parameter in question. Examples include, but are not limited to, equipment temperature (as above) and amplitude of vibrations.

The comprehensive data patterns allow engineers to recognize any parametric shifts that occur over time. These may include a shift in the mean value, where, for example, a sustained rise in temperature occurs at a level that isn't high enough to trigger a threshold alarm. Alternatively, an increase in the standard deviation of measurements, for example, when vibrations become unstable, may result. In either case, a parametric-shift alarm is triggered, allowing engineers to take remedial action.

USER-DEFINED MEMORY

✓ **Unique embedded sensor ID eliminates installation errors**

EMBRACING THE INTERNET OF THINGS

The advent of the Internet of Things (IoT) has changed the way engineers look at integrated processes in manufacturing and logistics. No longer do system designers consider production lines and distribution centers to be made up of discrete components – conveyors, actuators, motors, sensors, controllers and other similar hardware – but instead they consider more complex Functional Units.

Working with a functional unit, the need to identify individual components remains as important as ever; installing the wrong sensor could have far-reaching consequences. Contrinex Smart Sensors make it simple to get the right device in the right place, eliminating errors and avoiding costly interventions.

CUSTOMIZED SENSOR-DATA TAGS

Within each Smart Sensor, three read-write data tags are reserved for user-defined information. Designated the function tag, the location tag and the application-specific tag, respectively, they link individual sensors to specific applications or tasks, allowing process engineers to locate a discrete device quickly and easily. This simplifies installation and maintenance when more than one sensor is used in a single functional unit.

TAG NAME	SIZE [BYTE]	EXAMPLES
Function Tag	32	“Drive”, “Feed”, “Forward”
Location Tag	32	“A03.1”, “S45-2”
Application-Specific Tag	32	“end of motion”, “piston #1”, “fwd stroke”

SENSOR & ACCESSORIES OVERVIEW

SENSORS



PART REFERENCE	ART. NO.	HOUSING SIZE	SENSING RANGE	OUTPUT	CONNECTION
IDWE-M12MP-NMS-A0	330-020-479	M12	0...6 mm	PNP	M12 4-pin
IDWN-M12MP-NMS-A0	330-020-480	M12	0...10 mm	PNP	M12 4-pin
IDWE-M18MP-NMS-A0	330-020-481	M18	0...10 mm	PNP	M12 4-pin
IDWN-M18MP-NMS-A0	330-020-482	M18	0...20 mm	PNP	M12 4-pin

CONNECTING CABLES WITH OPEN ENDED WIRES*



PART REFERENCE	SOCKET			CABLE	
	Size	Pins	Config.	Material	Length
S12-4FVG-050	M12	4-pole	straight	PVC	5 m
S12-4FVW-050	M12	4-pole	right angle	PVC	5 m
S12-4FUG-050	M12	4-pole	straight	PUR	5 m
S12-4FUW-050	M12	4-pole	right angle	PUR	5 m

CONNECTING CABLES*



PART REFERENCE	SOCKET			CABLE		PLUG	
	Size	Pins	Config.	Material	Length	Size	Config.
S12-4FVG-050-12MG	M12	4	straight	PVC	5 m	M12	straight
S12-4FUG-050-12MG	M12	4	straight	PUR	5 m	M12	straight

MOUNTING BRACKETS



PART REFERENCE	TYPE	HOUSING SIZE COMPATIBILITY
ASU-0001-120	without limit stop	∅ 12 mm
ASU-0002-120	with limit stop	∅ 12 mm
ASU-0001-180	without limit stop	∅ 18 mm
ASU-0002-180	with limit stop	∅ 18 mm

T-CONNECTOR



PART REFERENCE	CONNECTION 1		CONNECTION 2		CONNECTION 3	
	Size	Pins	Size	Pins	Size	Pins
V12-5TPD-000-NN1	M12 plug	5	M12 socket	5	M12 plug	5

*Other cable lengths available: 2 m, 10 m, customized lengths possible

PNEUMATICS

MULTI-MODE MEASUREMENT OF PISTON DISPLACEMENT AND SPEED

Industrial equipment designers continually seek ways to reduce cycle times without compromising safety or performance, and require a monitoring capability for pneumatic cylinders that identifies deviations from the optimal deceleration profile without increasing complexity or cost. Rugged, multi-mode Smart Sensors from Contrinex, embedded in each cylinder, identify adverse trends in the deceleration profile, providing a cost-effective, unobtrusive fit-and-forget solution.

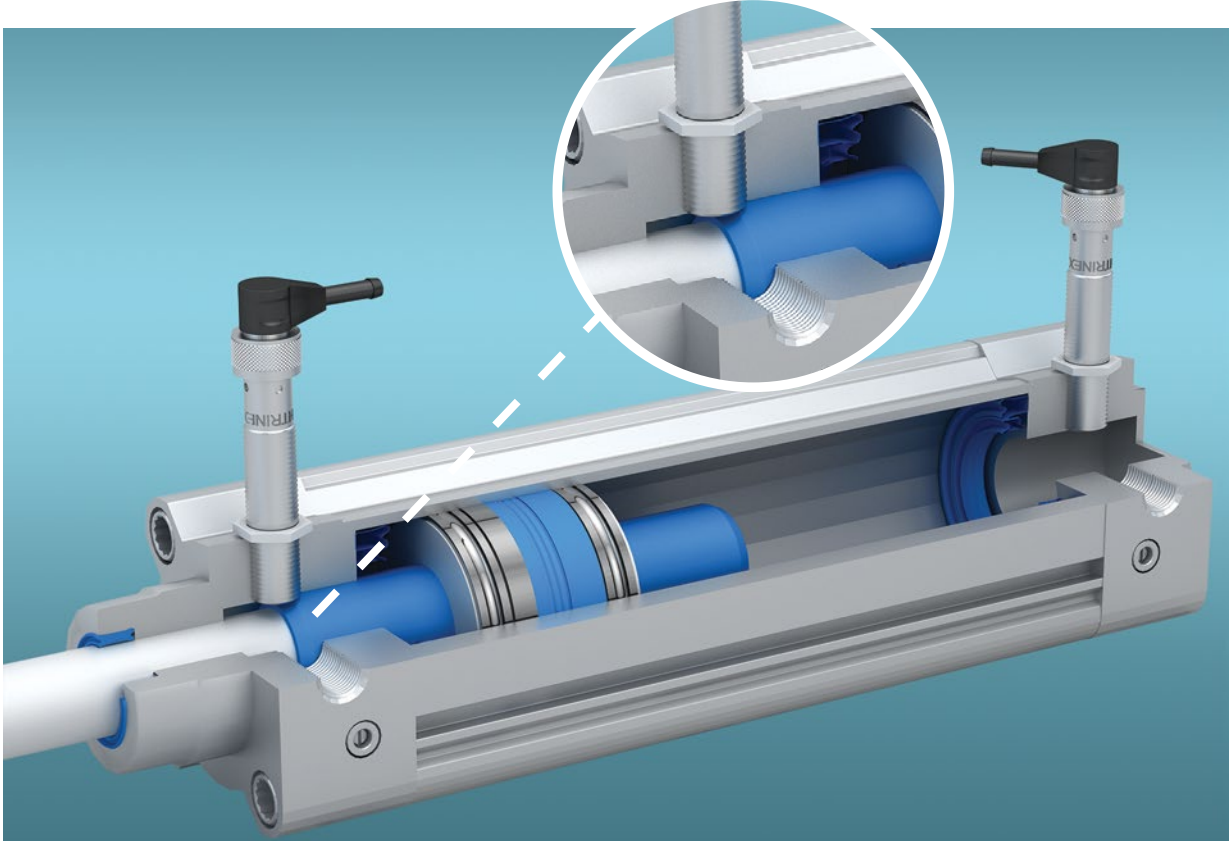

SMART TASKS



- High-resolution measurement of lateral piston displacement
- Repeated high-speed displacement measurement at timed intervals



- Monitor temperature, vibration and process cycle count for maintenance purposes
- Local storage of sensor configurations, allowing plug-and-play replacement when needed



- Generation of velocity gradient using on-board cumulative data store



- High-speed communication with central control system for time-critical events

CUSTOMER BENEFITS

- ✓ Embeddable inductive Smart Sensors offer multiple sensing modes in a single device, eliminating increased complexity and cost
- ✓ One-shot timer feature allows process engineers to identify deviations from the optimal deceleration profile, minimizing maintenance expense
- ✓ Dual-channel capability enables a local alarm to be triggered by an event-based exception, avoiding a plant-wide shut-down
- ✓ Industry-standard IO-Link connectivity provides a single interface to the machine control system
- ✓ Cumulative operating data for predictive maintenance, including temperature and operating-cycle count, is recorded in on-board data storage
- ✓ Sensor configurations are stored locally, allowing plug-and-play replacement of sensors when needed
- ✓ Proven technology ensures highly reliable fit-and-forget operation with no manual intervention

LINEAR GUIDE

PERFECT LOCATION AND POSITIONING OF LINEAR STAGE

Automation engineers designing high-speed assembly equipment with multiple linear transfers between workstations need to maximize speed and accuracy while keeping cost down. They require a single-sensor positional-control solution that delivers a high-speed approach to the critical areas and a slower, high-precision final positioning. An inductive Smart Sensor from Contrinex with IO-Link connectivity and multiple user-configurable outputs performs both the required tasks in a highly cost-effective manner.

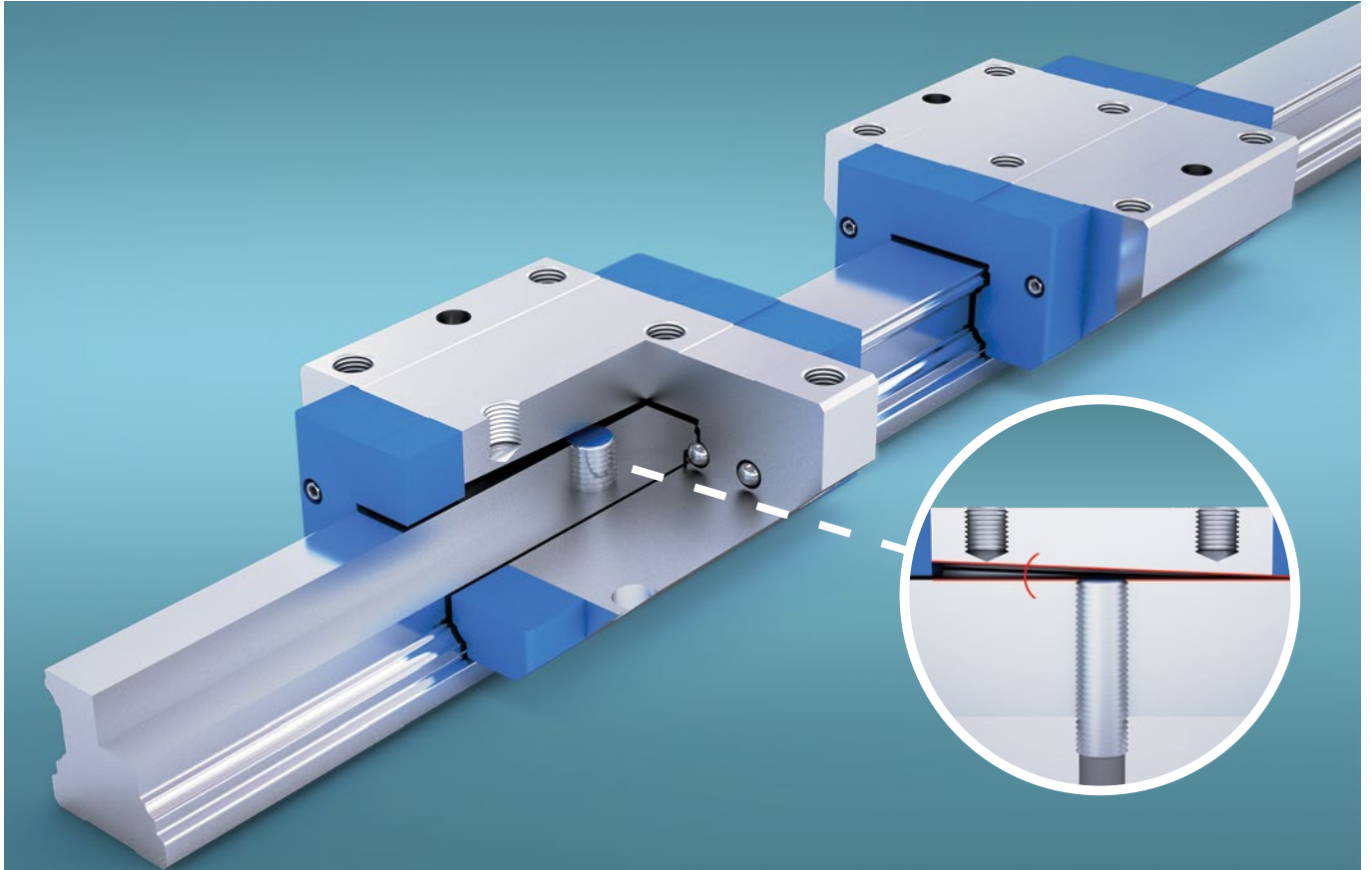

SMART TASKS



- ✦ Reliable position sensing on high-speed approach
- ✦ High-accuracy lateral position measurement during final stage positioning



- ✦ User-configured setpoints ensure precise window-mode positioning



- ✦ IO-Link smart profile simplifies control-system integration



- ✦ Sensor configuration is backed-up automatically on the local IO-Link Master

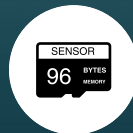

- ✦ Unique embedded sensor ID eliminates installation errors

CUSTOMER BENEFITS







- ✓ Rugged inductive Smart Sensors ensure accurate positioning of linear stages without compromising operational speed
- ✓ Single-sensor positional-control system is non-complex and highly affordable
- ✓ Compact embeddable M12 sensors fit unobtrusively and easily into off-the-shelf linear guide rails
- ✓ Industry-standard IO-Link connectivity provides a single interface to the machine control system
- ✓ Sensor configurations are stored locally, allowing plug-and-play replacement of sensors when needed
- ✓ Proven technology ensures highly reliable fit-and-forget operation with no manual intervention

SPINDLE

CHECKING TOOL PRESENCE AND POSITION IN A CONFINED SPACE

Modern CNC machining centers cope with ranges of materials, workpieces and cutting speeds that require different tool characteristics; spindles with automatic tool-changing are key to optimizing throughput. If a new tool fails to engage completely, damage to the tool, the workpiece or the spindle results. Smart Sensors from Contrinex, embedded in the body of the spindle, monitor the position of the tool during changes; any non-compliant measurements stop the process, triggering an alarm.

SMART TASKS

-  Precision real-time measurement of drawbar position
-  User-configured setpoints ensure accurate end-of-travel position sensing
-  Threshold alarms identify over-temperature and end of service life
-  Sensor configuration is backed-up automatically on the local IO-Link Master
-  Self-test function guards against sensor failure
-  High-speed notification of time-critical events

CUSTOMER BENEFITS

- ✓ Embeddable inductive Smart Sensor monitors drawbar position, detecting incomplete tool engagement and inhibiting further motion before damage occurs
- ✓ Single-sensor positional-control system is non-complex and highly affordable
- ✓ Embeddable M12 sensor fits snugly in the limited space available
- ✓ Industry-standard IO-Link connectivity provides a single interface to the machine control system
- ✓ Cumulative operating data for predictive maintenance, including temperature and operating-cycle count, is recorded in on-board data storage
- ✓ Sensor configurations are stored locally, allowing plug-and-play replacement of sensors when needed
- ✓ Proven technology ensures highly reliable fit-and-forget operation with no manual intervention.

RECYCLING

RELIABLE DETECTION OF DIFFERENT METALLIC MATERIALS

The global recycling industry continually seeks to reduce the cost of sorting and separating mixed-metal scrap. With the introduction of induction sorting, designers require sensors that operate accurately and at high speed to identify and separate fast-moving streams of ferrous and non-ferrous material in a single pass. Rugged inductive Smart Sensors from Contrinex, embedded immediately below the delivery belt, provide continuous high-speed detection across the full width of a conveyor.



SMART TASKS

-  Multi-mode target recognition at constant target distance
-  Unique embedded sensor ID eliminates installation error
-  High-speed localized communication with air-knife actuators
-  Cumulative cycle/target counting in each of two modes
- Threshold alarms identify over-temperature and end of service life
- Sensor configuration is backed-up automatically on the local IO-Link Master

CUSTOMER BENEFITS

- ✓ Embeddable inductive Smart Sensors detect ferrous and non-ferrous metal and trigger separation accurately and reliably
- ✓ A single array of sensors provides continuous detection across the full width of a conveyor
- ✓ Smart Sensors are easily able to identify material on fast-moving conveyors
- ✓ Industry-standard IO-Link connectivity provides a single interface to the machine control system
- ✓ Cumulative operating data for predictive maintenance, including temperature and operating-cycle count, is recorded in on-board data storage
- ✓ Sensor configurations are stored locally, allowing plug-and-play replacement of sensors when needed
- ✓ Proven technology ensures highly reliable fit-and-forget operation with no manual intervention

INTEGRATE SMART SENSORS IN YOUR IoT STRATEGY

CLOUD ANALYTICS



IO-Link SENSORS



SMART COMMUNICATION WITH CONTRINEX SENSORS

- Continuous monitoring of process data
- Continuous diagnosis of sensor status
- Plug & play solutions compatible with greenfield and brownfield applications

IO-LINK FUNCTIONALITY WITH INDUCTIVE SENSORS (PNP TYPES)



MULTI-MODE
HIGH-RESOLUTION
MEASUREMENT



EMBEDDED PREDICTIVE-
MAINTENANCE FEATURES

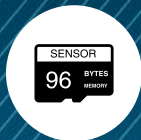

USER-DEFINED
MEMORY



USER-CONFIGURABLE
OUTPUTS



DIRECT DEVICE-TO-DEVICE
COMMUNICATION



DUAL CHANNEL

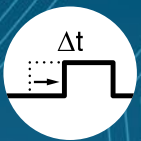

DELAY



STRETCH



ONE SHOT



TEMPERATURE



BITE



DETECTION
COUNTER

Terms of delivery and right to change design reserved.

HEADQUARTERS

CONTRINEX AG Industrial Electronics
Route du Pâqui 5 – PO Box – CH 1720 Corminboeuf
Switzerland
Tel: +41 26 460 46 46 – Fax: +41 26 460 46 40
Internet: www.contrinex.com – E-mail: info@contrinex.com

www.contrinex.com

© CONTRINEX AG 2020
999-414-002 – 10.20 – 500