

Auto Door Sensor

■ Features

- Adjustable hold time switch (2, 7, 15 seconds)
- 4-step detection angle adjustment (7.5°, 14.5°, 21.5°, 28.5°)
- Adjustable detection area (left/right area elimination)
- Max. detection area: 2460 mm x 86 mm (height 2.7 m)
- Wide range power supply:
24-240 VAC / 24-240 VDC (universal AC/DC type),
12-24 VAC / 12-24 VDC (universal AC/DC type)
- Built-in microprocessor



⚠ Please read "Caution for your safety" in operation manual before using.

■ Specifications

Model	ADS-AF	ADS-AE
Cover color	Silver	
Power supply	24-240VAC~ ±10% 50/60Hz, 24-240VDC= ±10% (ripple P-P: max. 10%)	12-24VAC~ ±10% 50/60Hz, 12-24VDC= ±10% (ripple P-P: max. 10%)
Power consumption	Max. 4VA (at 240VAC~)	Max. 2VA (at 24VAC~)
Control output	Contact type	1a
	Contact capacity※1	50VDC= 0.1A (resistive load)
Relay life cycle	Mechanical: Min. 20,000,000 times, Electrical: Min. 50,000 times	
Mounting height	2.0m to 2.7m (max. sensing distance: 3.0m)	
Sensing method	Infrared reflection method	
Sensing area	9 Point (refer to the below chart)	
Output holding time	Time delay approx. 0.5sec	
Stationary sensing time	Selectable 2sec, 7sec, 15sec (selectable by holding time setting switch)	
Interference prevention	H, L (selectable by interference prevention switch)	
Front sensing area	7.5°, 14.5°, 21.5°, 28.5°: 4 steps variable (adjusting by angle adjuster)	
Adjustable sensing area	(1, 2, 3 area), (7, 8, 9 area) Eliminate each by each : Adjusting with eliminating right/left sensing area lever	
Light source	Infrared emitting diode (modulated)	
Indicator	Operation indicator: Orange LED, Green LED, Red LED (refer to C-8 for the display status in operation)	
Connection method	Connector wire connection	
Insulation resistance	Over 20MΩ (at 500VDC megger)	
Noise immunity	±2,000V the square wave noise (pulse width: 1μs) by the noise simulator	
Dielectric strength	1,000VAC 50/60Hz for 1 minute	
Vibration	1.5mm amplitude at frequency of 10 to 55Hz in each X, Y, Z direction for 2 hours	
Shock	100m/s ² (approx. 10G) in each X, Y, Z direction for 3 times	
Environment	Ambient illumination	Sunlight: Max. 3,000lx, Incandescent lamp: Max. 3,000lx (receiver illumination)
	Ambient temperature	-20°C to 50°C, storage: -20 to 70°C
	Ambient humidity	35 to 85%RH, storage: 35 to 85%RH
Accessory	Cable: 2.5m, Mounting screw: 2, Mounting template	
Protection structure	IP50 (IEC standard)	
Material	Case: Acrylonitrile butadiene styrene, Lens: Acryl, Lens cover: Acryl	
Unit weight	Approx. 320g	

※1: Do not use Load which is beyond the rated capacity of contact point of Relay.

It can cause bad insulation, contact fusion, bad contact, relay breakdown, and fire etc.

※The temperature or humidity mentioned in Environment indicates a non freezing or condensation environment.

(A) Photoelectric Sensors

(B) Fiber Optic Sensors

(C) Door/Area Sensors

(D) Proximity Sensors

(E) Pressure Sensors

(F) Rotary Encoders

(G) Connectors/ Connector Cables/ Sensor Distribution Boxes/ Sockets

(H) Temperature Controllers

(I) SSRs / Power Controllers

(J) Counters

(K) Timers

(L) Panel Meters

(M) Tacho / Speed / Pulse Meters

(N) Display Units

(O) Sensor Controllers

(P) Switching Mode Power Supplies

(Q) Stepper Motors & Drivers & Controllers

(R) Graphic/ Logic Panels

(S) Field Network Devices

(T) Software

Unit Description

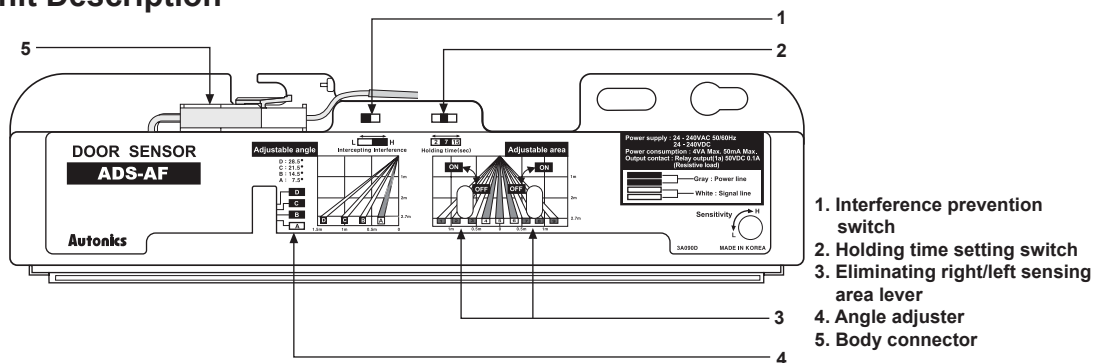

Dimensions

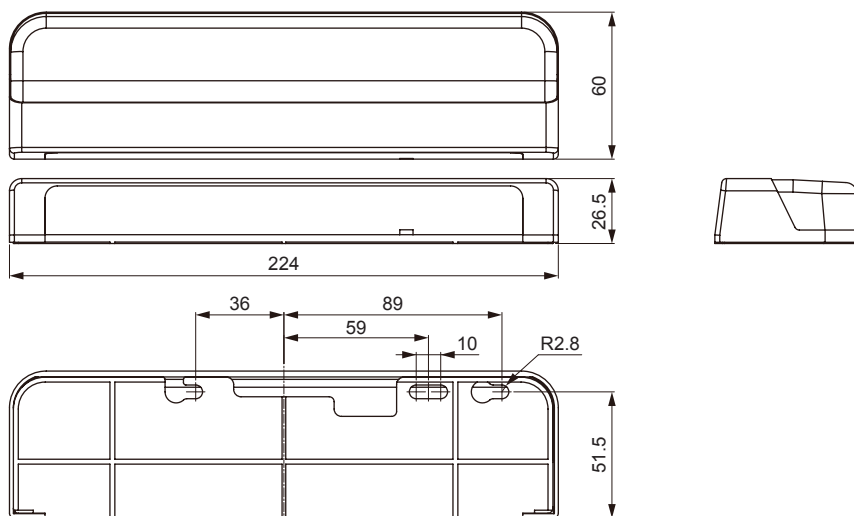

Mounting Method

Installation order

1. Attach mounting template at mounting position
(mounting height: 2.0m to 2.7m)
 - Drill Ø3.4mm hole based on mounting template.
 - In case of wiring the cable on the wall to hide the cable, drill Ø9mm hole.
 - Install the unit after removing the mounting template.

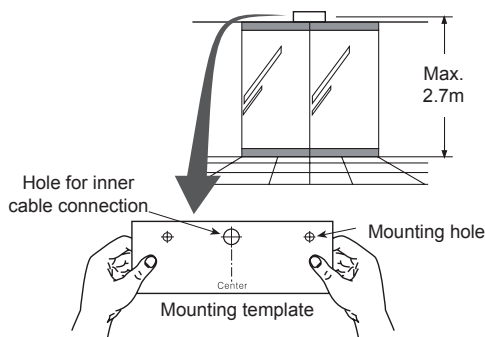

⚠ Caution

⚠ Warning It may cause electric shock.

- When this unit is used with cable outlet removed from cover, it must be installed indoors.
(Electric shock or damage can occur if water flows through cable outlet.)

⚠ Caution People can be jammed in the door.

- If this unit is installed higher than 2.7m in height, it may not detect short children.
- If this unit is installed lower than 2.0m in height, it may not work properly.

■ Installation

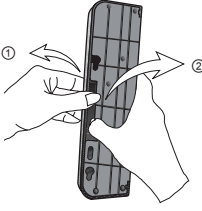
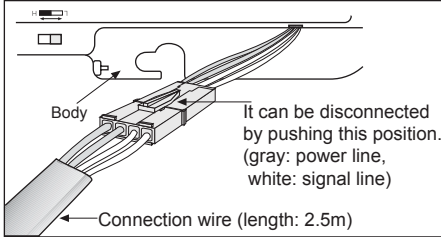
Installation order	⚠ Caution
<p>2. Please fix the unit with screws bolt after removing protection cover off.</p> 	<div style="background-color: #e0e0e0; padding: 5px; margin-bottom: 10px;"> <p>⚠ Caution Mounting the unit</p> </div> <ul style="list-style-type: none"> Do not put excessive tightening torque on screw bolt when mounting this unit. It may result in mounting hole damage. <p><How to remove protection cover></p> <ul style="list-style-type: none"> Pulling left thumb toward ①, key lock will be released and pull right thumb toward ②, protection cover and body will be detached.
<p>3. Connect the code part of the extension cable to main control part.</p> <ul style="list-style-type: none"> Please install the connector in order to connect with the body. 	
<p>4. Connect the connector of the body and the connector of the extension cable.</p> 	<div style="background-color: #e0e0e0; padding: 5px; margin-bottom: 10px;"> <p>⚠ Caution Connection of the connector</p> </div> <ul style="list-style-type: none"> Plug in the connector of the extension cable and the connector of the unit. The unit may not work normally by inferior contact.

■ Adjustment

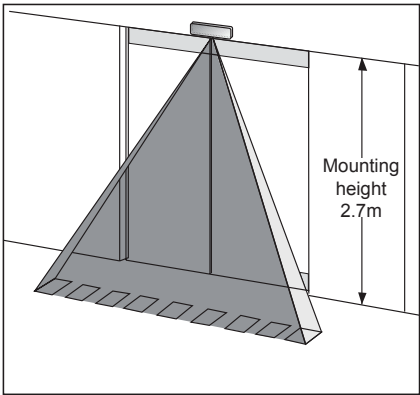
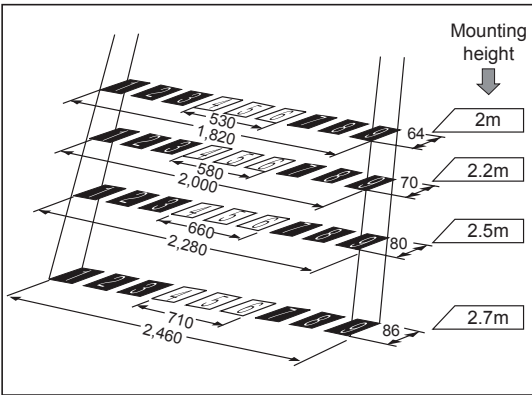
Please turn ON the power.													
<p>1. Check of the sensing area</p> <p>This unit has characteristic of the sensing area as below chart and figure.</p> 	<p style="text-align: right;">(unit: mm)</p>  <table border="1" style="margin-left: auto; margin-right: auto;"> <thead> <tr> <th>Mounting height</th> <th>Sensing area width at base (mm)</th> </tr> </thead> <tbody> <tr> <td>2m</td> <td>530</td> </tr> <tr> <td>2.2m</td> <td>1,820</td> </tr> <tr> <td>2.5m</td> <td>580 / 2,000</td> </tr> <tr> <td>2.7m</td> <td>660 / 2,280</td> </tr> <tr> <td></td> <td>710 / 2,460</td> </tr> </tbody> </table>	Mounting height	Sensing area width at base (mm)	2m	530	2.2m	1,820	2.5m	580 / 2,000	2.7m	660 / 2,280		710 / 2,460
Mounting height	Sensing area width at base (mm)												
2m	530												
2.2m	1,820												
2.5m	580 / 2,000												
2.7m	660 / 2,280												
	710 / 2,460												

- (A) Photoelectric Sensors
- (B) Fiber Optic Sensors
- (C) Door/Area Sensors
- (D) Proximity Sensors
- (E) Pressure Sensors
- (F) Rotary Encoders
- (G) Connectors/ Connector Cables/ Sensor Distribution Boxes/ Sockets
- (H) Temperature Controllers
- (I) SSRs / Power Controllers
- (J) Counters
- (K) Timers
- (L) Panel Meters
- (M) Tacho / Speed / Pulse Meters
- (N) Display Units
- (O) Sensor Controllers
- (P) Switching Mode Power Supplies
- (Q) Stepper Motors & Drivers & Controllers
- (R) Graphic/ Logic Panels
- (S) Field Network Devices
- (T) Software

Adjustment

2. Adjustable sensing area

Adjustable 7° in each step.
(sensing area angle step: 7.5° to 28.5°)

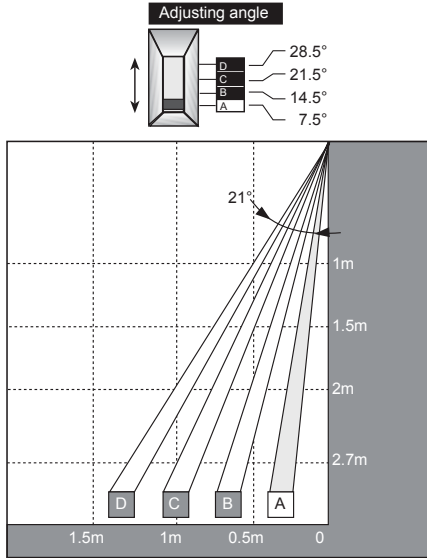

Caution People can be jammed in the door.

- The unit is not safety sensor. Install the fail-safe device before using the unit.

3. Adjustment of Left, Right sensing area width

Sensing area width [1], [2], [3] can be eliminated by left lever, 789 by right lever.

- Use the unit as removing non-sensing area by the lever adjusting width at narrow sensing area.
- Turn the adjuster till it stops it toward arrow direction by a (-)driver.

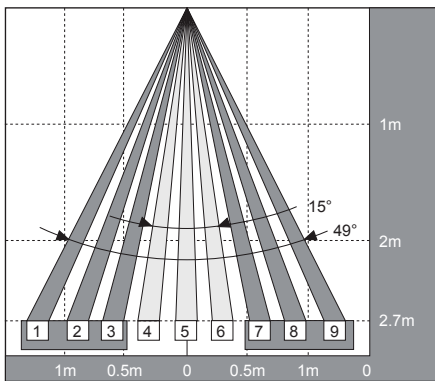
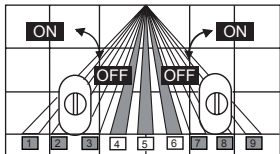

Caution Doors may malfunction.

- When eliminating the right/left sensing range, be sure to install the unit at place where a person approaches at the front of the door.
- In case of eliminating sensing area width: If a person approaches at the side of the door, they may not be detected and the door will not open.
- The sensing range for position of eliminating lever is as below.
- It can eliminate [1], [2], [3] by left lever and [7], [8], [9] by right lever at the once.

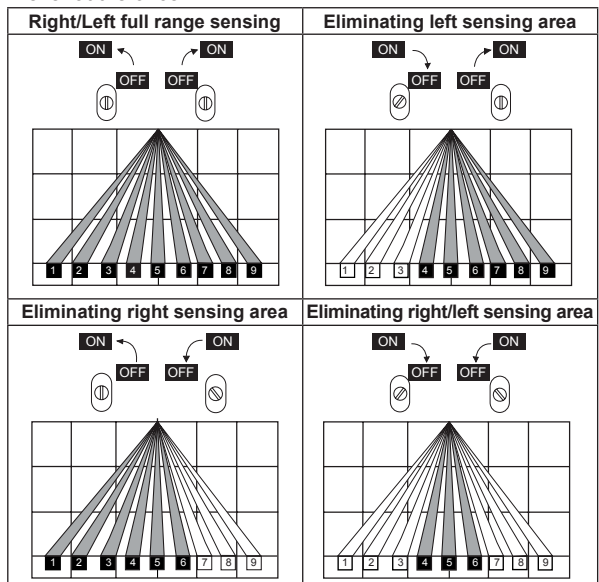

It is not able to eliminate individual areas like elimination of area [1] or [7].

■ Adjustment

4. How to set the switch for interference prevention

In case of using several door sensors adjacently, please set the interference prevention switches of the sensors differently.

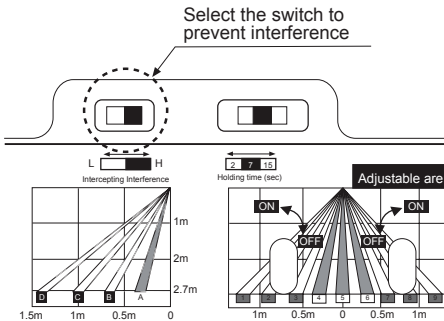

⚠ Caution Doors may malfunction.

When several door sensors are installed simultaneously without considering any interference prevention, it may cause malfunction by another door sensor even though there is no moving object.

< Interference prevention >

If sensing area of the door sensors is overlapped, set each switch in difference or install the unit on non-overlapped sensing area.

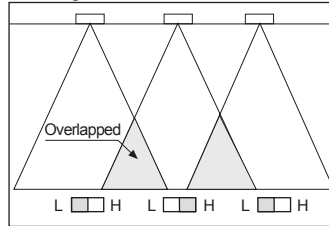

5. Holding time switch setting

It is able to set the holding time by the holding time switch. (selectable 2sec, 7sec, 15sec)

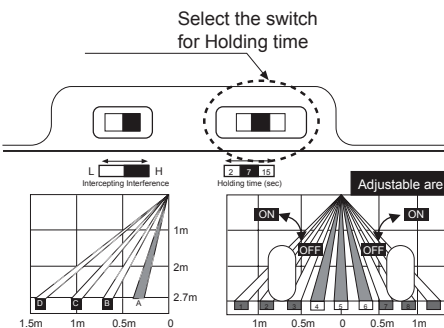

⚠ Caution People can be jammed in the door.

- The unit is not safety sensor. Install the fail-safe device before using the unit.
- The door will close after the time set by the holding time switch.

<Stationary sensing>

- When an object stays in the sensing area, output is kept in ON status during set holding time after output holding time.
- After set holding time, output turns OFF and the door closes.

6. Sensitivity Setting

- Even though people in the sensing area, if the sensor does not operate, turning the adjuster up to H. The sensitivity will be increased.



- Even though people in the sensing area, if the sensor operated, turning the adjuster up to L. The sensitivity will be decreased.

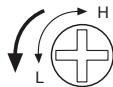

⚠ Caution Door can be opened and closed.

Please check the normal operation by turning the power ON/OFF after finishing the sensitivity setting. It may not operate normally after wrong sensitivity setting.

7. Unit cover and stripping

- Mount the cover on the unit.
- In case of using outlet to wire exposed cable, remove the cable outlet as below.

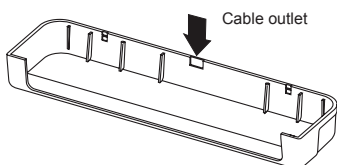

- Wrench and strip the protection cover putting a flathead screwdriver.

⚠ Warning It may cause electric shock.

- Use this unit with unit cover.
- Be sure that this unit does not come in direct touch with water. It may cause a damage to the equipment or cause electric shock.
- In case of without the cable outlet, the unit must be installed at inner position of door.
- Be sure that cable outlet does not come in direct touch with water. It may cause a damage to the equipment or cause electric shock.

(A) Photoelectric Sensors

(B) Fiber Optic Sensors

(C) Door/Area Sensors

(D) Proximity Sensors

(E) Pressure Sensors

(F) Rotary Encoders

(G) Connectors/ Connector Cables/ Sensor Distribution Boxes/ Sockets

(H) Temperature Controllers

(I) SSRs / Power Controllers

(J) Counters

(K) Timers

(L) Panel Meters

(M) Tacho / Speed / Pulse Meters

(N) Display Units

(O) Sensor Controllers

(P) Switching Mode Power Supplies











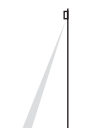
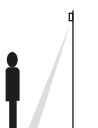
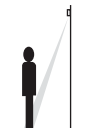
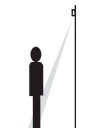
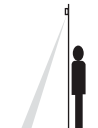









(Q) Stepper Motors & Drivers & Controllers

(R) Graphic/ Logic Panels

(S) Field Network Devices

(T) Software

■ Adjustment

8. Sensing standby status						
Right after turning on the power, the product is in the sensing standby status.		• After the sensing standby status is finished, sensing is stable.				
9. Check of sensing operation						
Check sensing operation as the below table.						
Entry activation						
		Turning on the power	Turning on the power	Enter the sensing area	Holding sensing	Out of sensing area
Operation indicator	Orange	LED ON 	LED OFF 	LED OFF 	LED OFF 	LED OFF 
	Green	LED OFF 	LED ON 	LED OFF 	LED ON 	LED ON 
	Red	LED OFF 	LED OFF 	LED ON 	LED OFF 	LED OFF 
Output contact					After holding time, OFF 	After 0.5sec, OFF 
10. Maintenance		<div style="border: 1px solid black; padding: 5px; display: inline-block;"> ⚠ Warning It may cause electric shock. </div>				
<ul style="list-style-type: none"> • If the sensing lens is unclean, the unit may cause malfunction. • In this case, please clean it with dry tissue and natural detergent. • Do not use an organic materials such as benzene, etc. It may cause malfunction of sensing part. 		<ul style="list-style-type: none"> • Do not wash the unit with water. • Do not repair or disassemble the unit. 				

■ Troubleshooting

Malfunction	Cause	Troubleshooting
It does not work.	Power voltage	Check the power cable and adjust power voltage.
	Cable cut, disconnection	Check connector and wiring.
Sometimes it does not work.	The sensing lens are unclean	Clean the lens with dry tissue and natural detergent.
The door is opened even if people do not enter in sensing area.	There are moving objects.	Check surrounding environment for installation.
	By occurring sudden change of sensing area.	Check surrounding environment for installation.
	Sensing area is overlapped.	Install the unit to avoid overlap for sensing area. Set the switch intercepting interference.
	There is the equipment such as motor, neon lamp, generator, or high voltage line causing strong electric wave, noise.	Do not install the equipment causing strong electric wave, noise near the sensor.
	A drop of water is placed at the lens.	Remove a drop of water.

■ Installation Environment

1. This product is not qualified for waterproof.
Please install without being directly contacted with rain or snow, etc.
It may cause breakdown and short circuit.

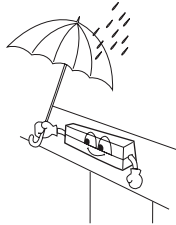

2. Do not install in the place where having reflecting light like sunshine directly reaches.
It may does not operate normally.

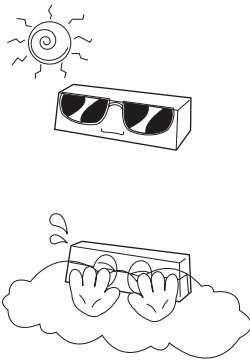

4. If you place a movable object in the sensing area, it may cause malfunction by sensing the object because of natural phenomenon like wind, etc.



5. The sensing lens must be installed face to the door's threshold. If it faces the wall or roof, it may not operate normally.

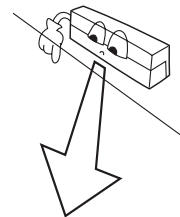

■ Caution for Using

1. Follow instructions in 'Caution for Using'.
Otherwise, It may cause unexpected accidents.
2. 12-24VDC, 12-24VAC power supply should be insulated and limited voltage/current or Class 2, SELV power supply device.
3. Use the product, 3 sec after supplying power.
When using separate power supply for the sensor and load, supply power to sensor first.
4. When using switching mode power supply to supply the power, ground F.G. terminal and connect a condenser between 0V and F.G. terminal to remove noise.
5. When connecting a DC relay or other inductive load, remove surge by using diodes or varistors.
6. Wire as short as possible and keep away from high voltage lines or power lines, to prevent surge and inductive noise.
7. This unit may be used in the following environments.
 - ①Indoors (in the environment condition rated in 'Specifications')
 - ②Altitude max. 2,000m
 - ③Pollution degree 3
 - ④Installation category II

(A) Photoelectric Sensors

(B) Fiber Optic Sensors

(C) Door/Area Sensors

(D) Proximity Sensors

(E) Pressure Sensors

(F) Rotary Encoders

(G) Connectors/ Connector Cables/ Sensor Distribution Boxes/ Sockets

(H) Temperature Controllers

(I) SSRs / Power Controllers

(J) Counters

(K) Timers

(L) Panel Meters

(M) Tacho / Speed / Pulse Meters

(N) Display Units

(O) Sensor Controllers

(P) Switching Mode Power Supplies

(Q) Stepper Motors & Drivers & Controllers

(R) Graphic/ Logic Panels

(S) Field Network Devices

(T) Software