

Type 8922

Software of f(x) configuration
Software der f(x)-Konfiguration
Logiciel de f(x) configuration

Operating Instructions - Software

Bedienungsanleitung - Software



Manuel d'utilisation - Logiciel

We reserve the right to make technical changes without notice.
Technische Änderungen vorbehalten.
Sous réserve de modifications techniques.

© Bürkert Werke GmbH & Co. KG, 2017

Operating Instructions 1705/€_ÖWÖP_008Féí Fí / Original DE

CONTENT

1	THE OPERATING INSTRUCTIONS	5
1.1	Symbols.....	5
1.2	Definitions of terms.....	5
2	AUTHORIZED USE	6
3	GENERAL INFORMATION	6
3.1	Contact addresses.....	6
3.2	Information on the Internet.....	6
4	PRODUCT DESCRIPTION	7
4.1	Basic principles.....	7
5	USER INTERFACE	8
5.1	Areas of the user interface.....	8
5.2	Tool bar of the f(x) configuration.....	9
5.2.1	büS-Map.....	9
5.2.2	Fx-Log.....	9
5.2.3	System Monitor.....	10
5.2.4	New function f(x).....	10
5.3	Configured f(x) functions.....	11
5.3.1	Function status.....	11
6	OPERATION AND FUNCTION	12
6.1	Starting Bürkert-Communicator 	12
6.2	Add interface 	12
6.3	Creating a graphical f(x) function.....	13
6.4	Making base settings.....	14
6.5	Selecting inputs and outputs or parameters.....	15
6.6	Applying configuration.....	16
6.7	Concluding configuration of values.....	16
6.8	Program editor.....	17

6.8.1	Example: Characteristic adjustment	18
6.8.2	Important information.....	20
6.9	büS network configuration	22
6.10	Adjusting parameters	23
7	ERROR MESSAGES	24
7.1	Display of the device status.....	24
8	ADDITIONAL INFORMATION	25
8.1	Licenses.....	25

1 THE OPERATING INSTRUCTIONS

The operating instructions describe the basic operation of the f(x) configuration. Keep these instructions in a location which is easily accessible to every user and make these instructions available to every new owner of the product.

Important safety information.

Failure to observe these instructions may result in hazardous situations.

- ▶ The operating instructions must be read and understood.

1.1 Symbols

DANGER!

Warns of an immediate danger!

- ▶ Failure to observe the warning will result in fatal or serious injuries.

WARNING!

Warns of a potentially dangerous situation!

- ▶ Failure to observe the warning may result in serious injuries or death.

CAUTION!

Warns of a potential danger!

- ▶ Failure to observe the warning may result in moderate or minor injuries.

NOTE!

Warns of damage!

- Failure to observe the warning may result in damage to the device or other equipment.

 Indicates important additional information, tips and recommendations.

 Refers to information in these operating instructions or in other documentation.

▶ designates instructions for risk prevention.

→ designates a procedure which you must carry out.

✓ Indicates a result.

1.2 Definitions of terms

The term "product" used in these instructions always refers to Type 8922.

2 AUTHORIZED USE

Non-authorized use of Type 8922 may be dangerous to people, nearby equipment and the environment.

The f(x) configuration is designed for the dynamic function extension of Bürkert devices.

- ▶ Use according to the authorized data, operating conditions, and conditions of use specified in the contract documents and operating instructions.
- ▶ Software only in conjunction with third-party devices and components recommended and authorized by Bürkert.
- ▶ Correct installation and careful use and maintenance are essential for reliable and faultless operation.
- ▶ Use the software only for its intended purpose.

3 GENERAL INFORMATION

3.1 Contact addresses

Germany

Bürkert Fluid Control Systems
Sales Center
Christian-Bürkert-Str. 13-17
D-74653 Ingelfingen
Tel. + 49 (0) 7940 - 10-91 111
Fax + 49 (0) 7940 - 10-91 448
Email: info@de.buerkert.com

International

You can find the contact addresses on the Internet at: www.burkert.com

3.2 Information on the Internet

The operating instructions and data sheets for Type 8922 can be found on the Internet at:

www.burkert.com

4 PRODUCT DESCRIPTION

The f(x) configuration is designed for the dynamic function extension of Bürkert devices. It allows a convenient configuration and implementation of additional functions.

Possible applications of f(x):

- Assignment of switching commands for Bürkert devices.
- Measurement data is relayed to external actuators or via bÜS to Bürkert devices.
- Saving and displaying recorded measure values.
- Implementation of control algorithms, as well as additional program logic.
- Provision of signal sources (e.g. ramp).
- Modification of signals (e.g. filter).

4.1 Basic principles

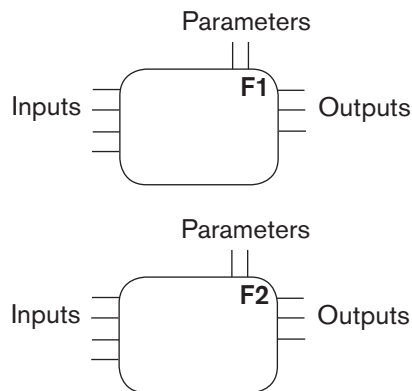

The f(x) configuration can be used to expand the device by one or more functions. Examples of functions are e.g. a timer, a graphical program or a controller.

Each function is run independently of the other.

The sequence consists of:

- Read in inputs
 - Calculation 1 cycle of the function
 - Read out outputs
 - Wait until the next cycle time
- } Cycle time, e.g. 1 s

Source and destination of the inputs and outputs can be specified in the bÜS-Map. The procedure is described in the chapter [“6.9 bÜS network configuration”](#).

5 USER INTERFACE

This chapter describes the user interface of the graphical programming and refers to the symbols and terms of the Bürkert-Communicator.



The operating instructions for Bürkert-Communicator can be found on the Bürkert homepage at www.burkert.com.

5.1 Areas of the user interface

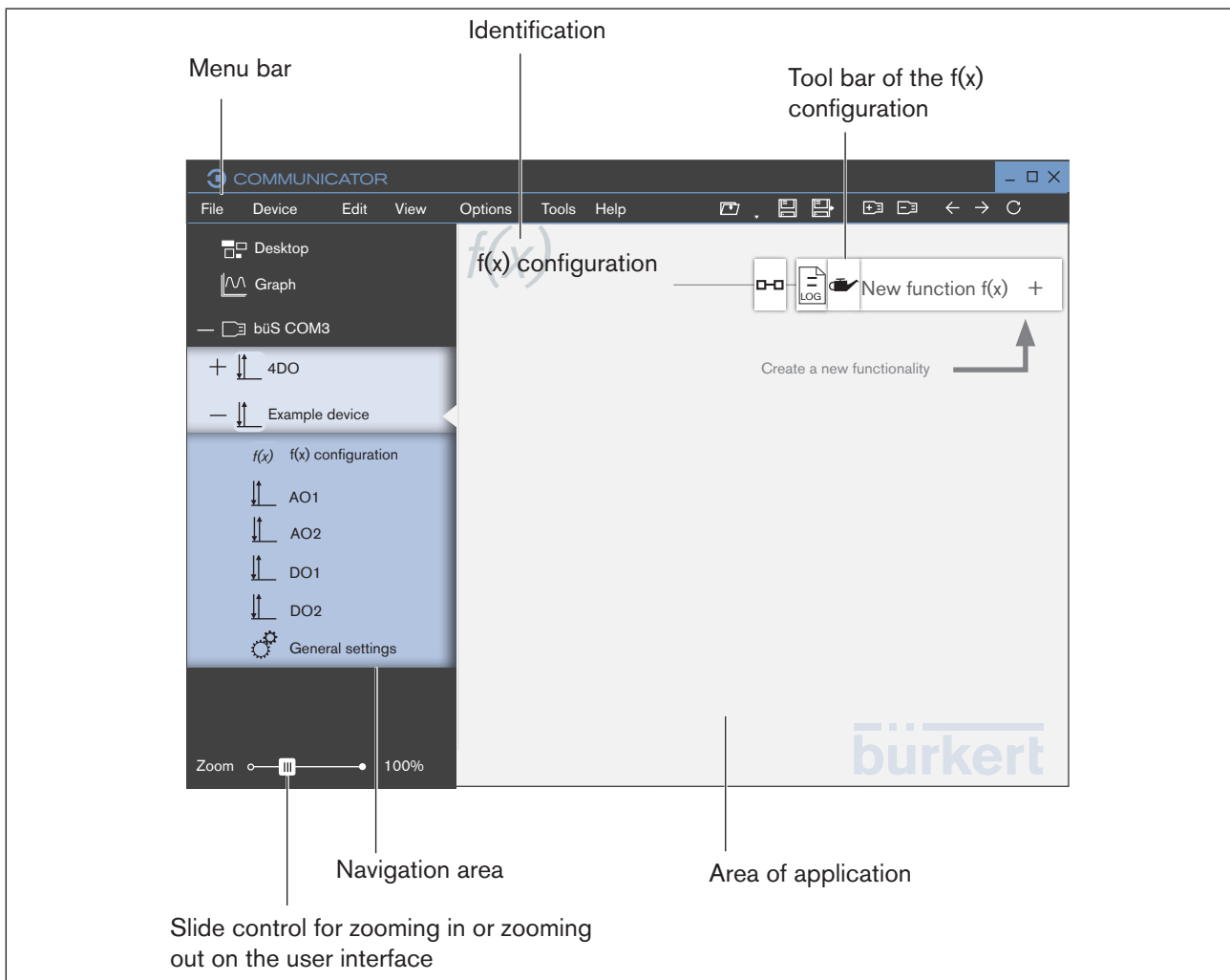

Figure 1: Overview of user interface of the $f(x)$ configuration



The symbols have tool tips (quick guide) which describe the commands.
Required user interactions are identified by orange operating elements.

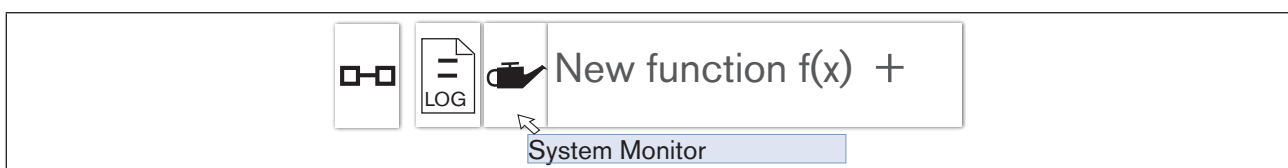





Figure 2: Tool tips

5.2 Tool bar of the f(x) configuration



Functions of the f(x) configuration on the tool bar:

Icon	Command or description
 büS-Map	Navigate to the büS-Map.
 Fx-Log	Opens the Fx-Log.
 System Monitor	Opens the System Monitor.
 Create a new functionality	Creates a new functionality.

5.2.1 büS-Map

büS-Map is a representation of the currently connected büS network. büS-Map shows all devices and products connected to the interface with the respective inputs and outputs. The user can edit the büS network configuration here.

The configuration is described in chapter [“6.9 büS network configuration”](#).

5.2.2 Fx-Log

The Fx-Log is an internal log of the created f(x) functions. All messages are displayed since this view was last opened or since the device was last started.

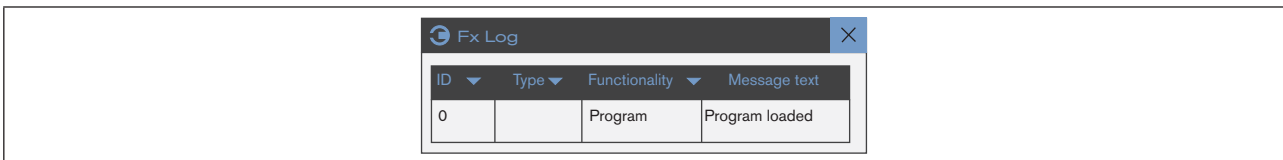

Figure 3: Fx-Log

5.2.3 System Monitor

The System Monitor provides an overview of the current utilization of the device. The processor load (CPU) is represented as a guide value. Also the minimum, maximum and the latest runtime is displayed for the cycle time and runtime analysis of each f(x) function.

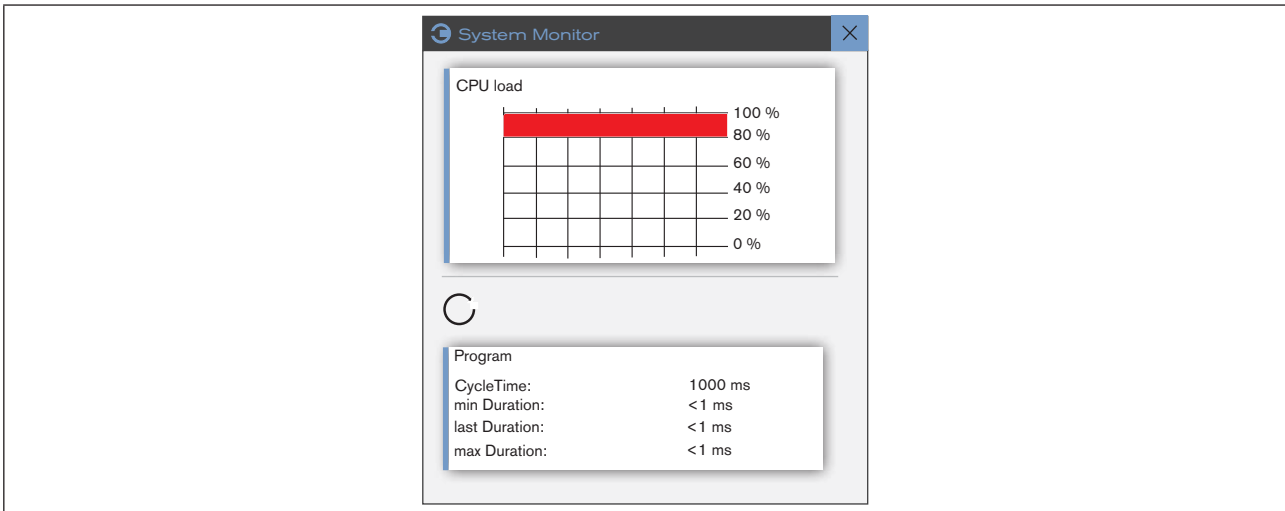

Figure 4: System Monitor

5.2.4 New function f(x)

This button allows the creation of a new f(x) function. The user can select either the graphical programming or a different functionality using a drop-down list.

The user can compile his own functions for graphical programming. An exact description follows in chapter ["6.3 Creating a graphical f\(x\) function"](#).

The other functionalities cannot be changed by the user. They are functions, which have been preprogrammed by the manufacturer and are available on the device, but must be created and can be parametrized by the user.

- Select **New function f(x)**.
- Select required functionality.

5.3 Configured f(x) functions

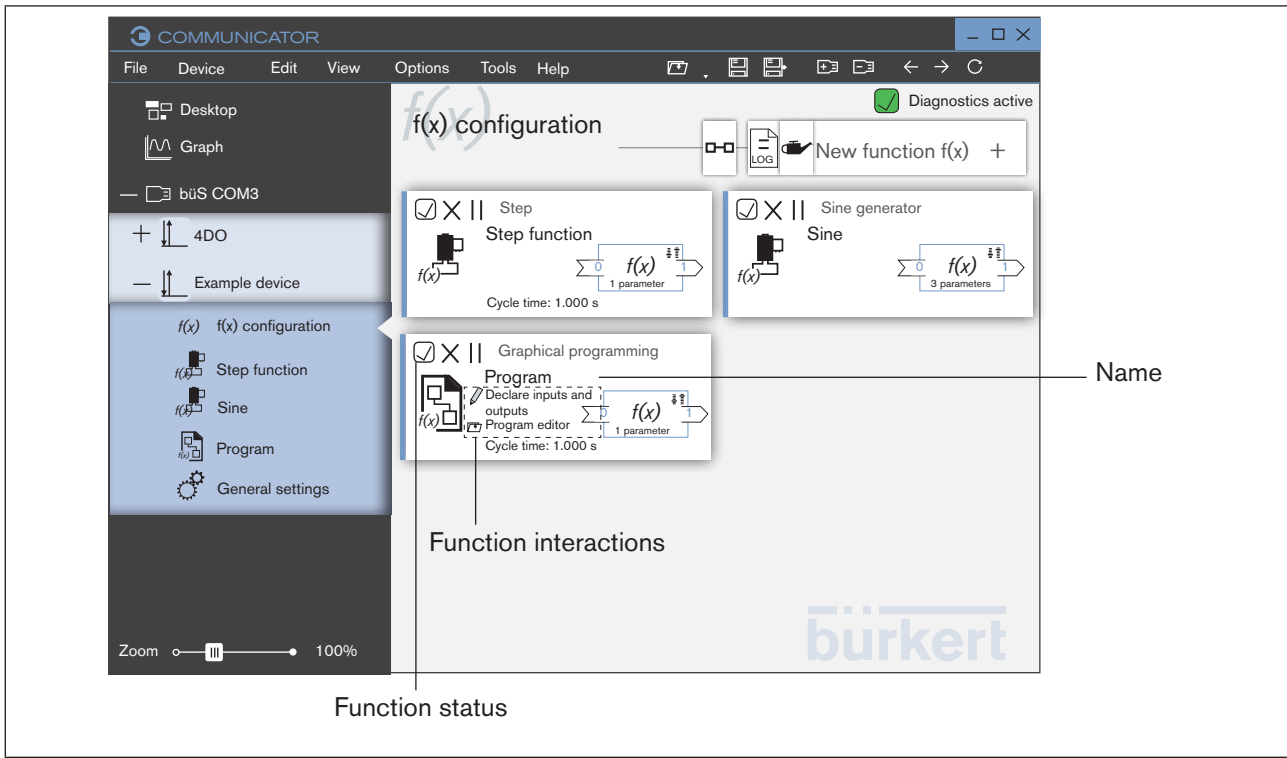





Figure 5: Example with three configured f(x) functions

5.3.1 Function status

Icon	Status	Description
	Error	Function has an error, user action required (restart / new configuration).
	Function is waiting	When all inputs consume their own values, the function starts independently, no user action required (when all inputs have been linked in the büS network configuration, see chapter "6.9").
	Function is running	

6 OPERATION AND FUNCTION

This chapter describes how to create and configure the graphical programming. The description of the procedure for the configuration refers to the symbols and terms of the Bürkert-Communicator user interface.



The operating instructions for Bürkert-Communicator can be found on the Bürkert homepage at www.burkert.com.

6.1 Starting Bürkert-Communicator

→ Start Bürkert-Communicator (e.g. via Windows start menu).

6.2 Add interface

The interfaces must be added by the user. The devices or products connected to the interface are then automatically added to a sub folder per device or product in the navigation area.

Icon	Menu	Command or description
	Add file / interface...	Adds a new interface.



→ Click on .

A dialog field for selecting the interface opens followed by a dialog field for making further settings:

→ Select interface **büS stick**.

→ Click on **Connect**.

The interface and the associated devices and products are transferred to the navigation area.

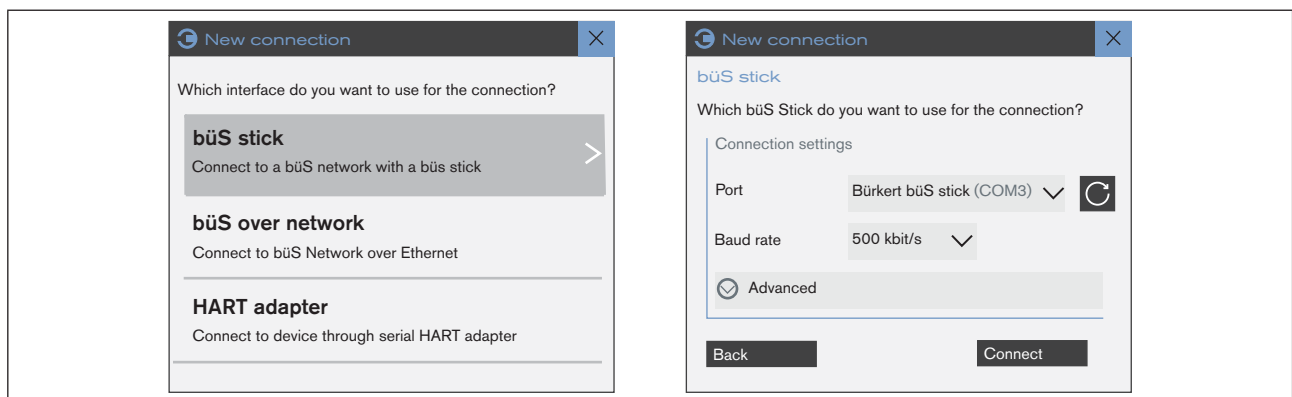

Figure 6: Add interface (example)

6.3 Creating a graphical $f(x)$ function

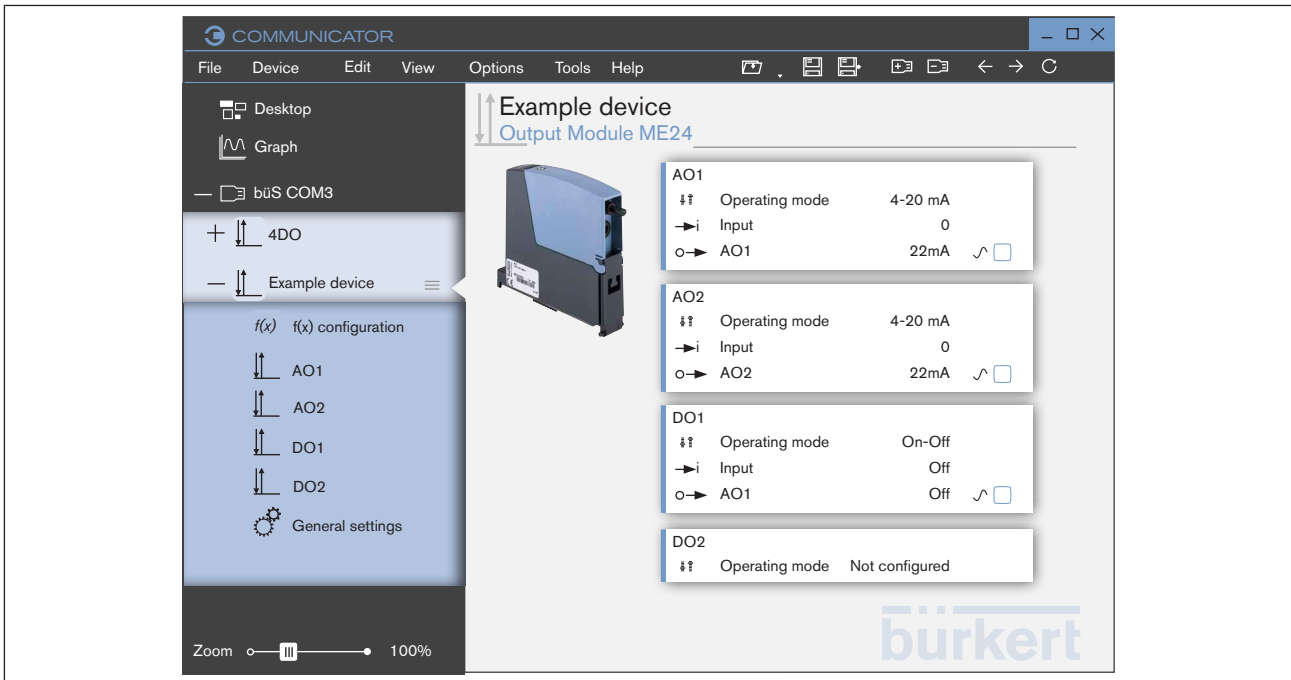

Figure 7: Selecting $f(x)$ configuration in the navigation area

- Select device with $f(x)$ function in the navigation area.
- Select **$f(x)$ configuration**.
- Select **New function $f(x)$** on the tool bar.
- Select **Graphical programming**.

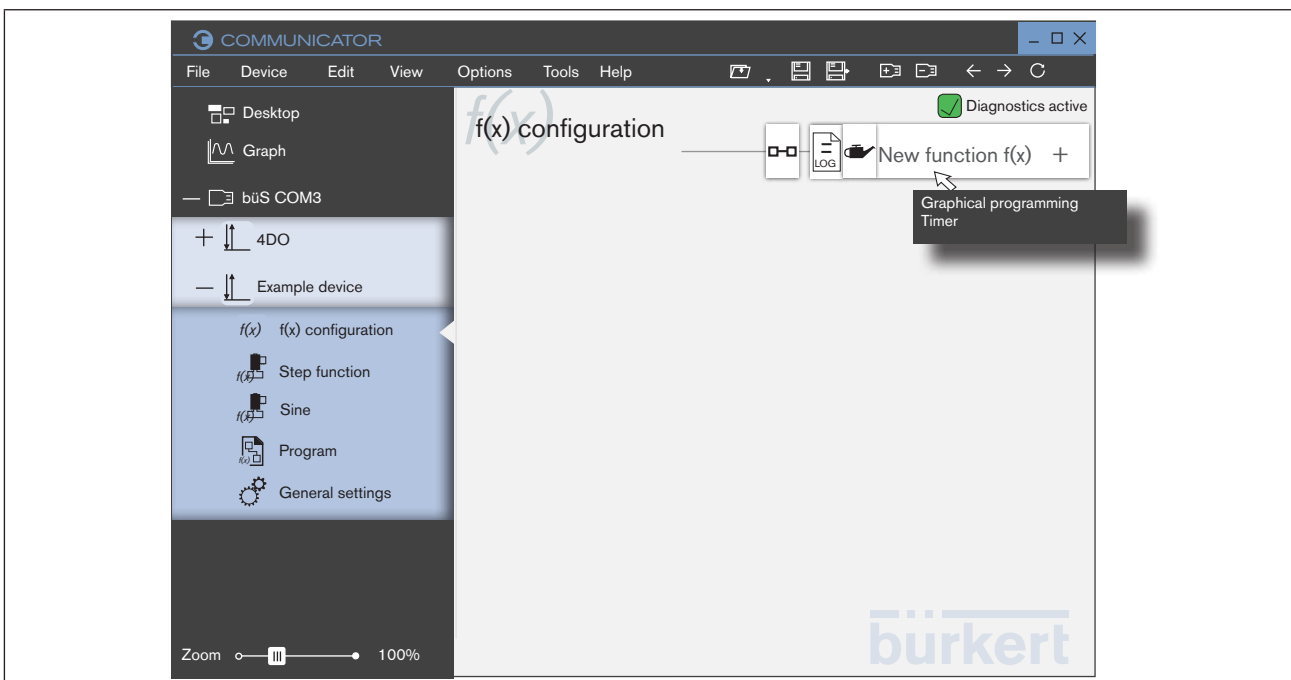

Figure 8: Selecting graphical programming

- ✓ Wizard for configuring the graphical programming opens.

6.4 Making base settings

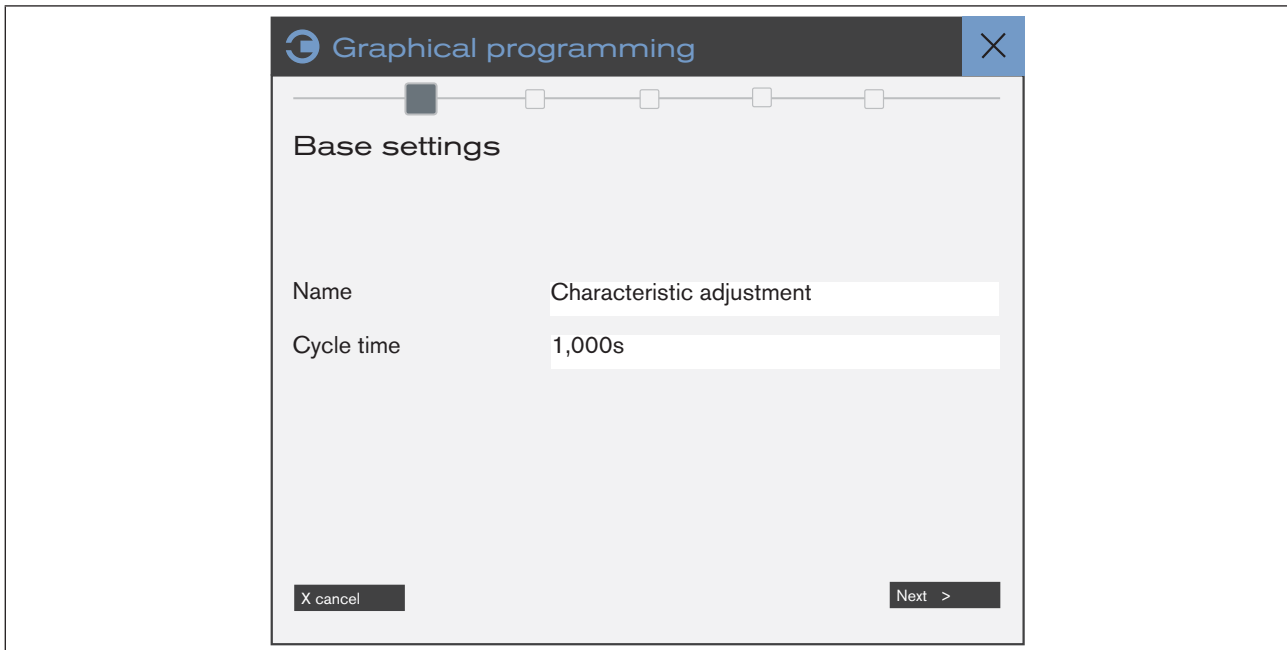
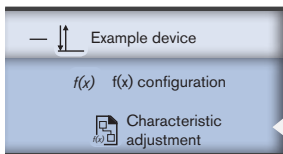

Figure 9: Base settings

→ Enter name and cycle time.

Name: Name assigned by the user appears in the navigation area as a device function.



This name also appears in the büS-Map and the setting levels.

Cycle time: Specify how often the function is to be recalculated, see chapter [“4.1 Basic principles”](#).

→ Click **Next**.

6.5 Selecting inputs and outputs or parameters

Value types available in the büS network are highlighted.

→ Add inputs and outputs or parameters using drag-and-drop or by double-clicking.
Right-clicking allows several values of the same unit to be added.

Inputs and outputs are linked to other values (see “6.9”), parameters are available only within the function and are adjusted in the application area (see “6.10”).

→ Add or adjust all required values.

→ Click **Next**.

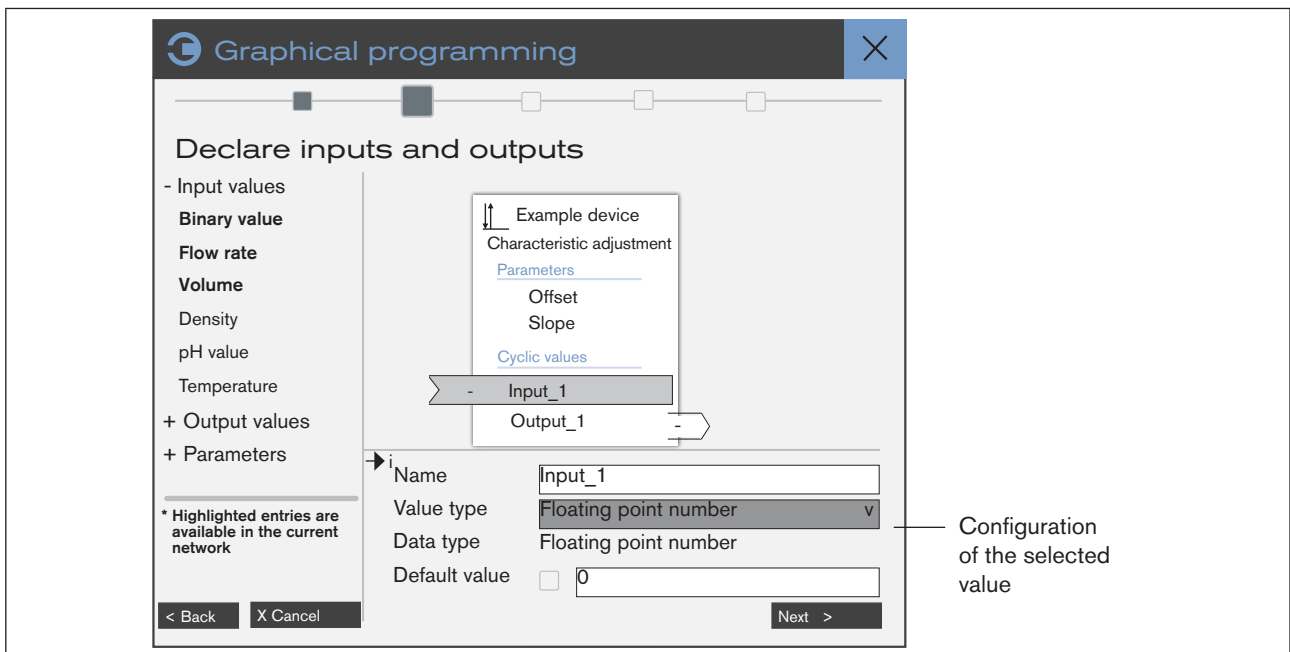

Figure 10: Adding inputs and outputs

Icon	Function or description (example values)
	Parameter
	Output value
	Input value
Standard ▾	Drop-down list
	Text field

6.6 Applying configuration

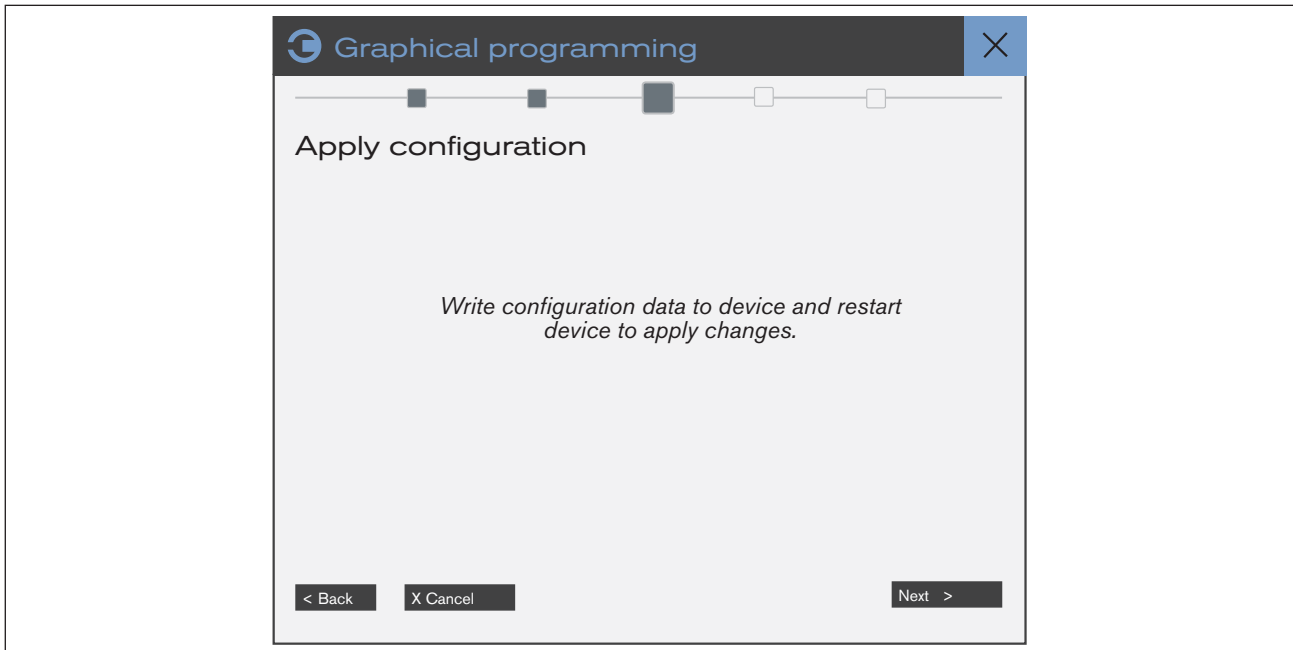

Figure 11: Applying configuration

→ Click **Next**.

By confirming this page, the configuration implemented in the previous steps is transferred to the device. The device is restarting.

✔ Device is restarting.

6.7 Concluding configuration of values

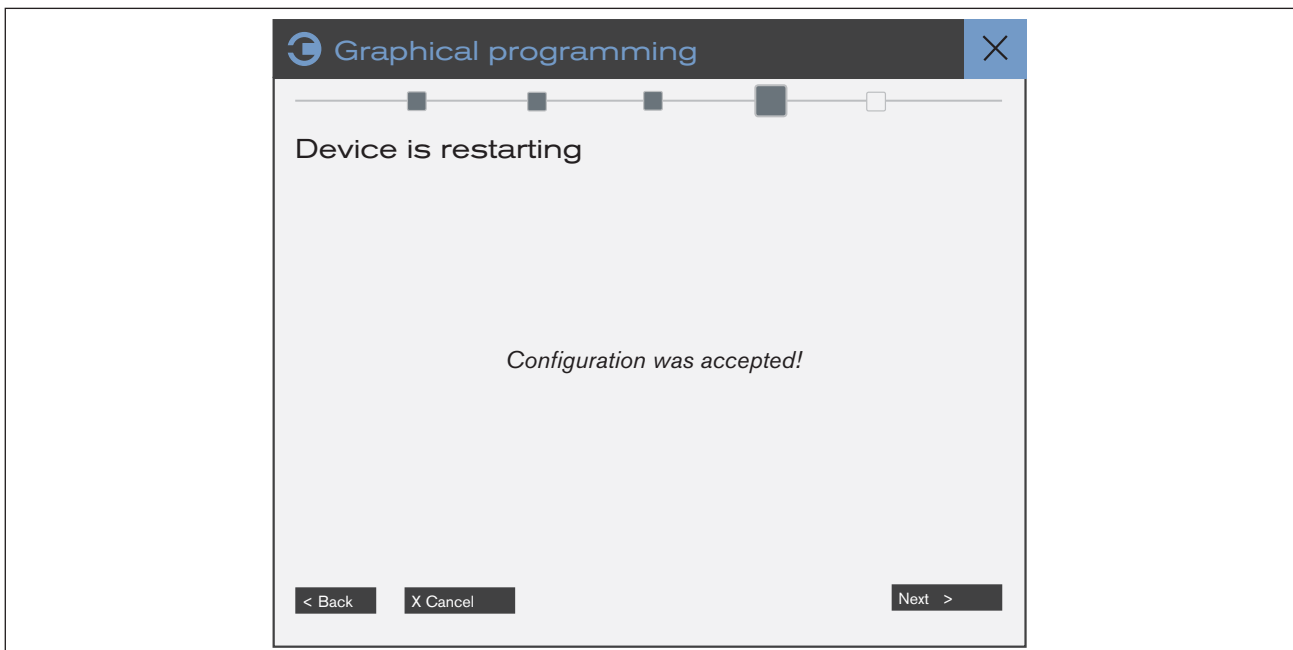

Figure 12: Restart device

✔ Configuration was accepted.

When the device has been restarted, you can continue with the configuration.

→ Click **Next**.

6.8 Program editor

The program editor is a graphical programming system. In the program editor, programming, simulation, test and start-up are connected in a tool. Special blocks allow the online monitoring of signals and signal characteristics. Programming can be data flow oriented in a function block diagram or control flow oriented as a flow chart.



The exact description of the program editor can be found in the online help instructions which are in the program editor in the menu bar under **?** -----> **Index**.

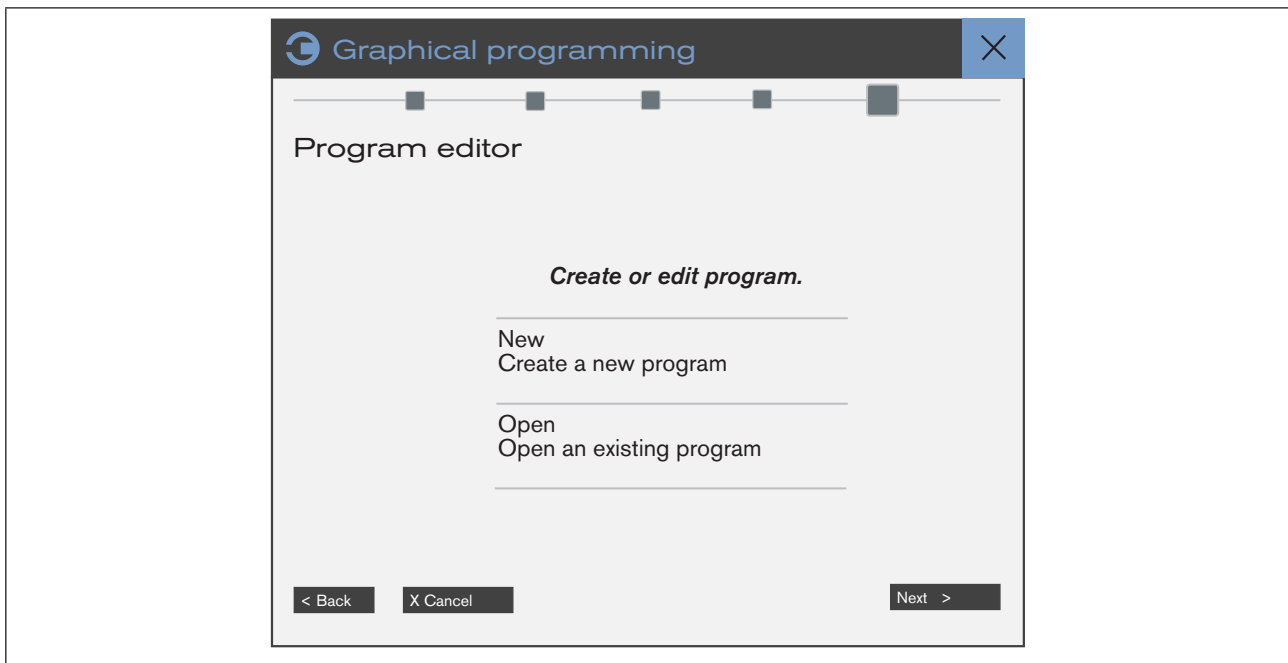

Figure 13: Creating or editing program

→ Click **New** and save project in a folder.

✔ Program editor starts.

6.8.1 Example: Characteristic adjustment

Characteristics are adjusted in this example.

→ Select required blocks from the library and drag into the program area using drag-and-drop.

→ When positioning, select the data type **FLOAT** from the list, as the inputs and outputs in chapter “6.5” have this data type.

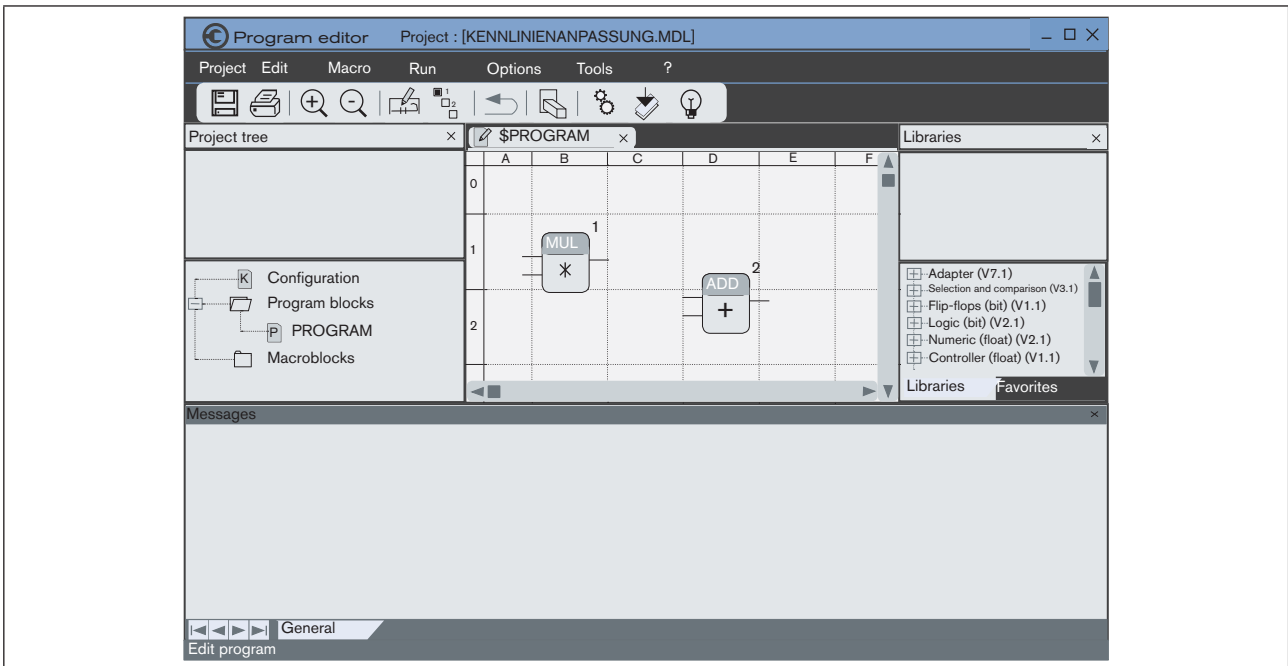

Figure 14: Program editor

→ Connect blocks by clicking on the output and the input.

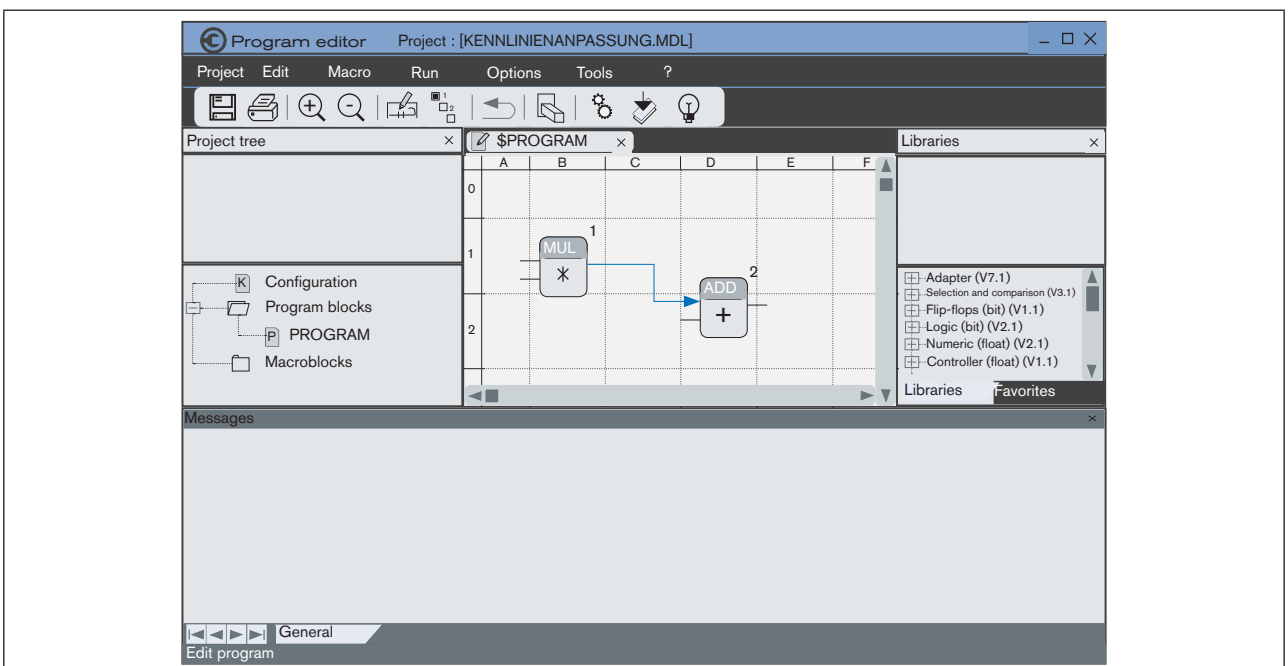

Figure 15: Connecting the blocks

→ Assign inputs and outputs (variables):

Using the right mouse button, click the block connection and select **Assign variable** from the list.
Variables with matching type are available for selection.

→ Select variable and confirm with **OK**.

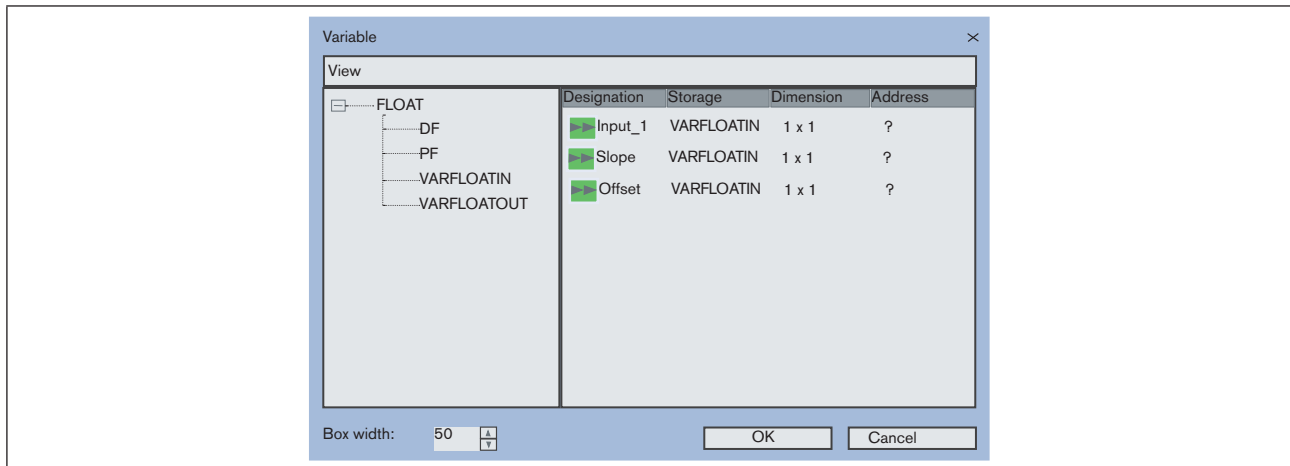

Figure 16: Assigning variable

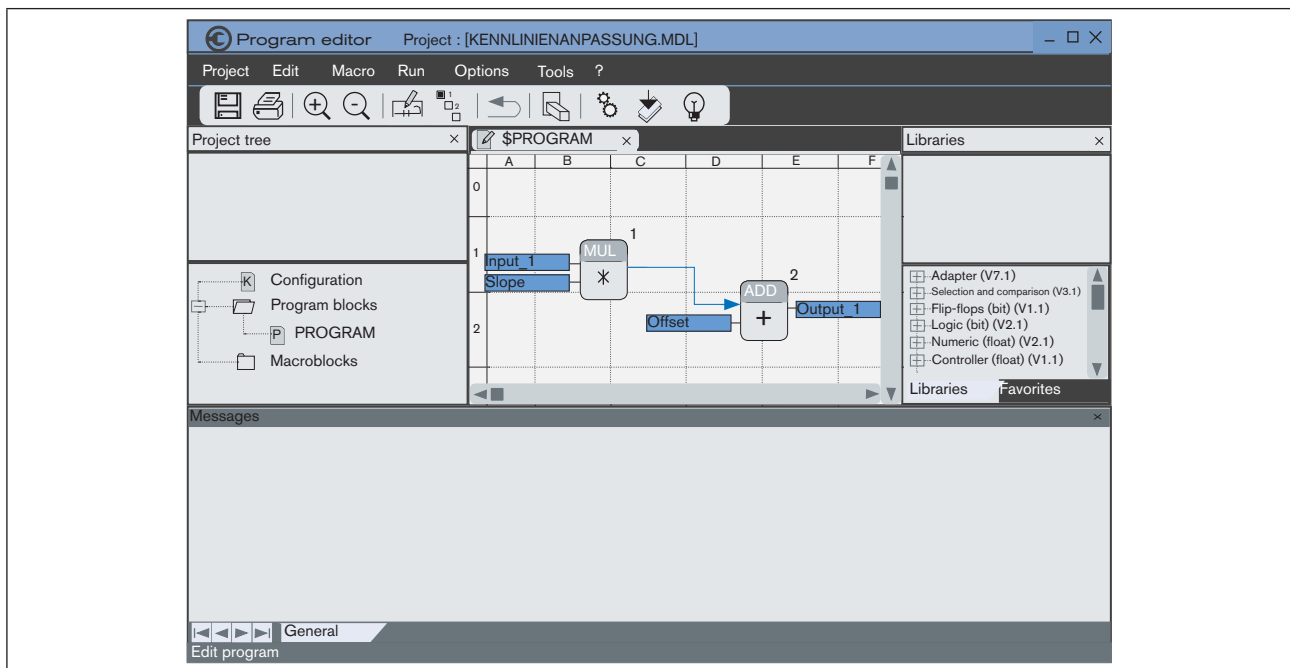



Figure 17: Blocks with assigned variables

→ Select  download symbol on the tool bar.

→ Confirm with **OK**.

✓ Program is transferred to the device. The function starts as soon as all inputs consume a value, see [“6.9 büS network configuration”](#).

6.8.2 Important information

Connecting the blocks to different data types

2 blocks with different data types cannot be directly connected to each other. The block **Converter** is available in the library for this purpose.

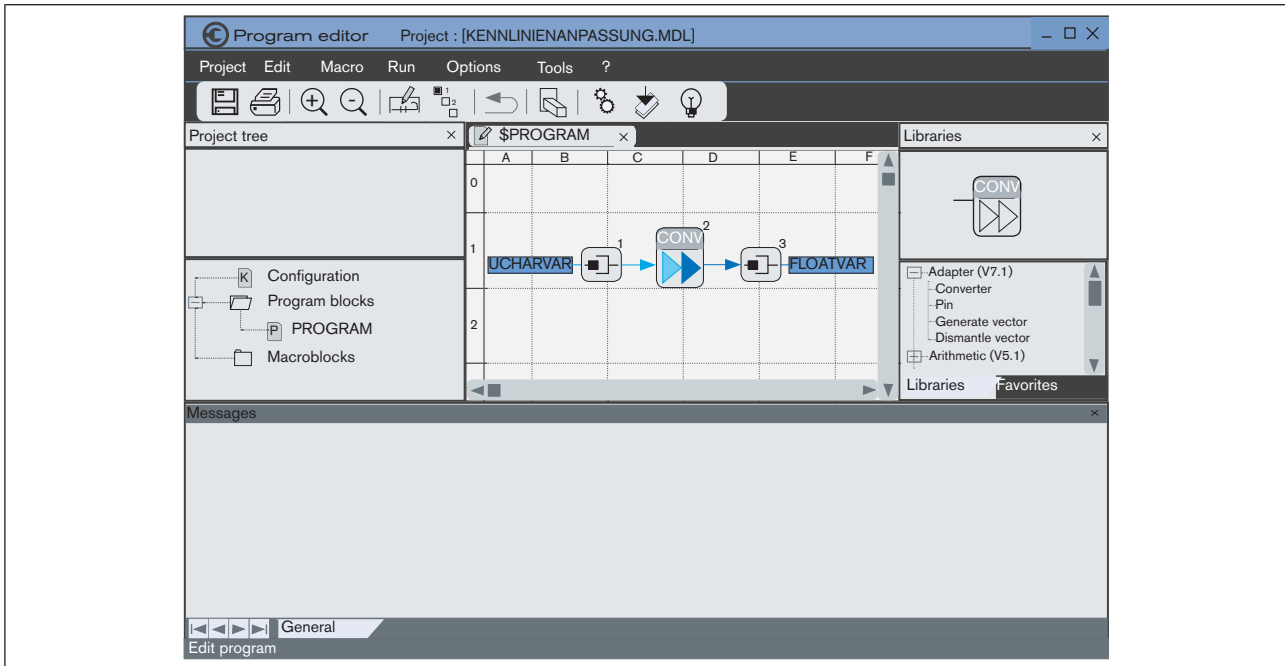

Figure 18: Converting blocks

Explaining the menu **Tools** on the menu bar of the program editor

The most important commands of the program editor are on the tool bar and menu bar. 2 selection options are available under the menu **Tools**:

- **Tools** -----> **Global Variables.**

The window Global Variables provides an overview of all inputs and outputs as well as parameters which are shown in chapter "6.5". Variables can be synchronized by clicking on the command.

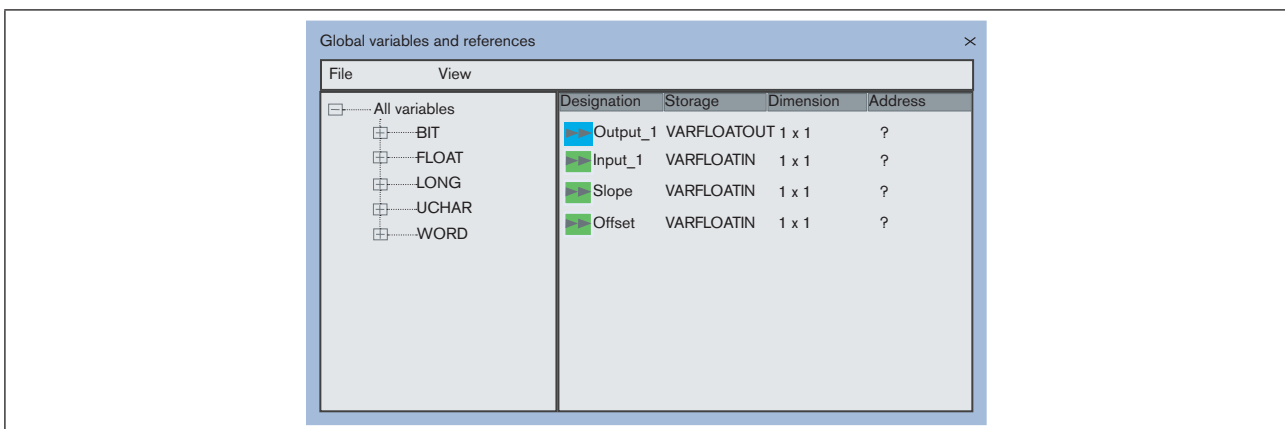



Figure 19: Global variables and references

- **Tools** -----> **Update the I/O variables.**

If the inputs and outputs as well as parameters shown in chapter "6.5" do not match those in the Global Variables window, they can be synchronized by clicking on the command.

Editing a program: Online and Offline operating state

→ Click  Online/Offline symbol on the tool bar. Online operating state starts.

 The program cannot be edited in the Online operating state.

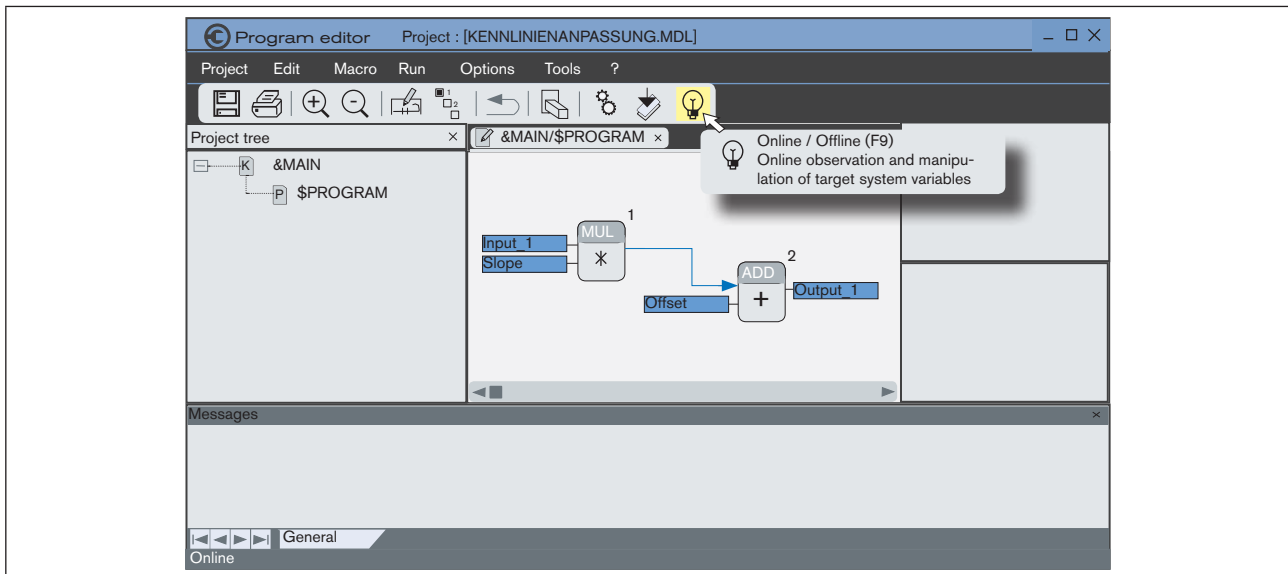

Figure 20: Online operating state

→ Press  Online/Offline symbol or F9.

→ Using the right mouse button, click on **\$PROGRAM** and select **Edit**.

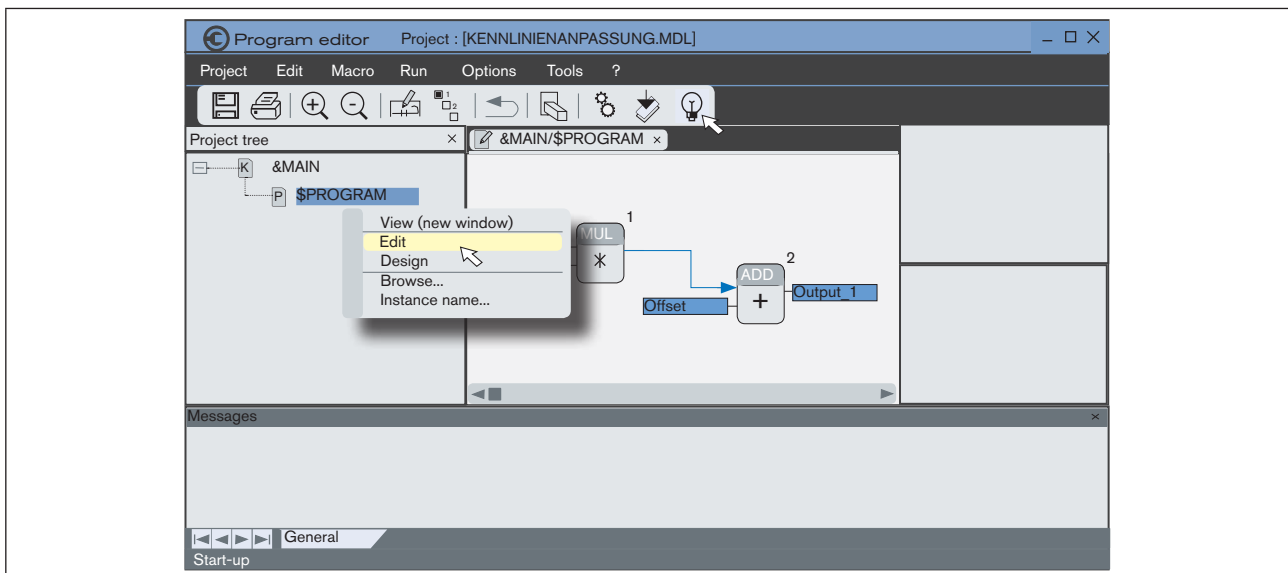



Figure 21: Changing to Offline operating state

 Program can be edited again.

6.9 büS network configuration

- Connect Bürkert büS stick to büS network.
- Connect büS stick to the PC.
- Start Bürkert-Communicator.
- Add interface: Select symbol  from tool bar.
- Select interface in the navigation area.
- Select register card **büS-Map**.

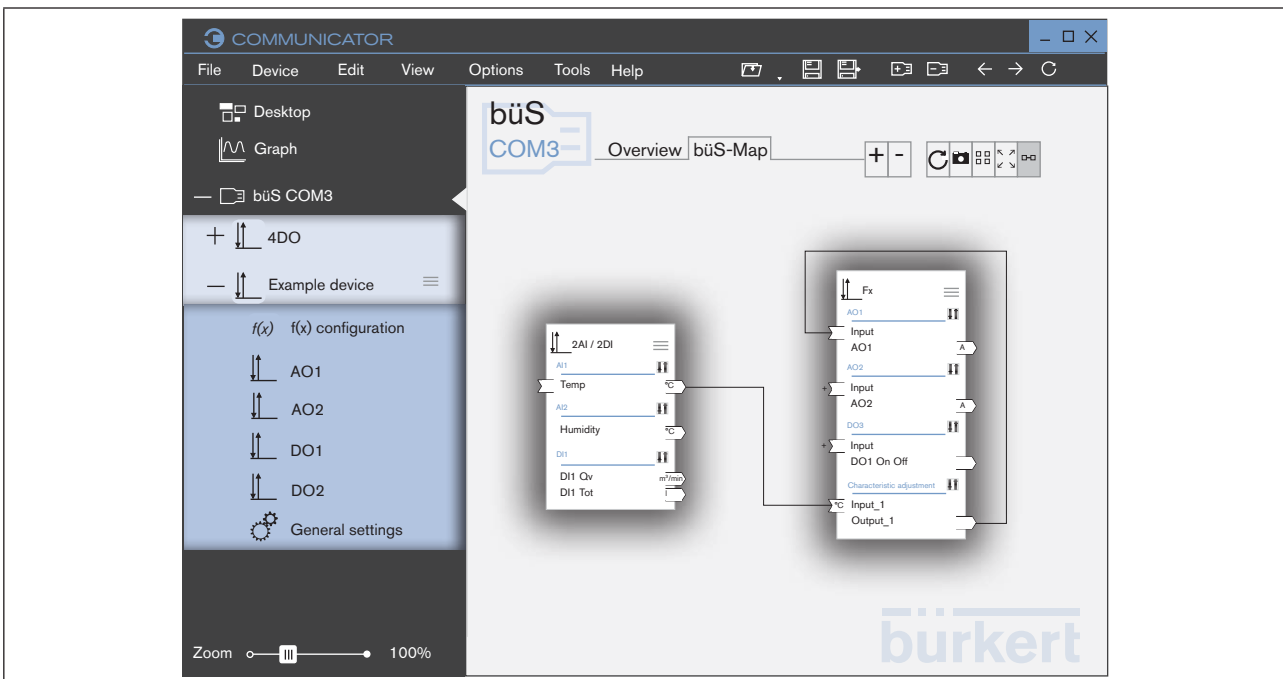

Figure 22: büS-Map

- Using drag-and-drop, link the inputs and outputs.
Dashed line connections do not establish an active connection between devices.
When the mouse is moved over a connection, the compatible connection points are highlighted in blue.
- Click **Apply changes**.
- All configured devices are restarted.



Further information on the büS-Map can be found in the operating instructions for the Bürkert-Communicator.

6.10 Adjusting parameters

All parameters of the function are displayed and can be adjusted by clicking on the new function in the navigation area.

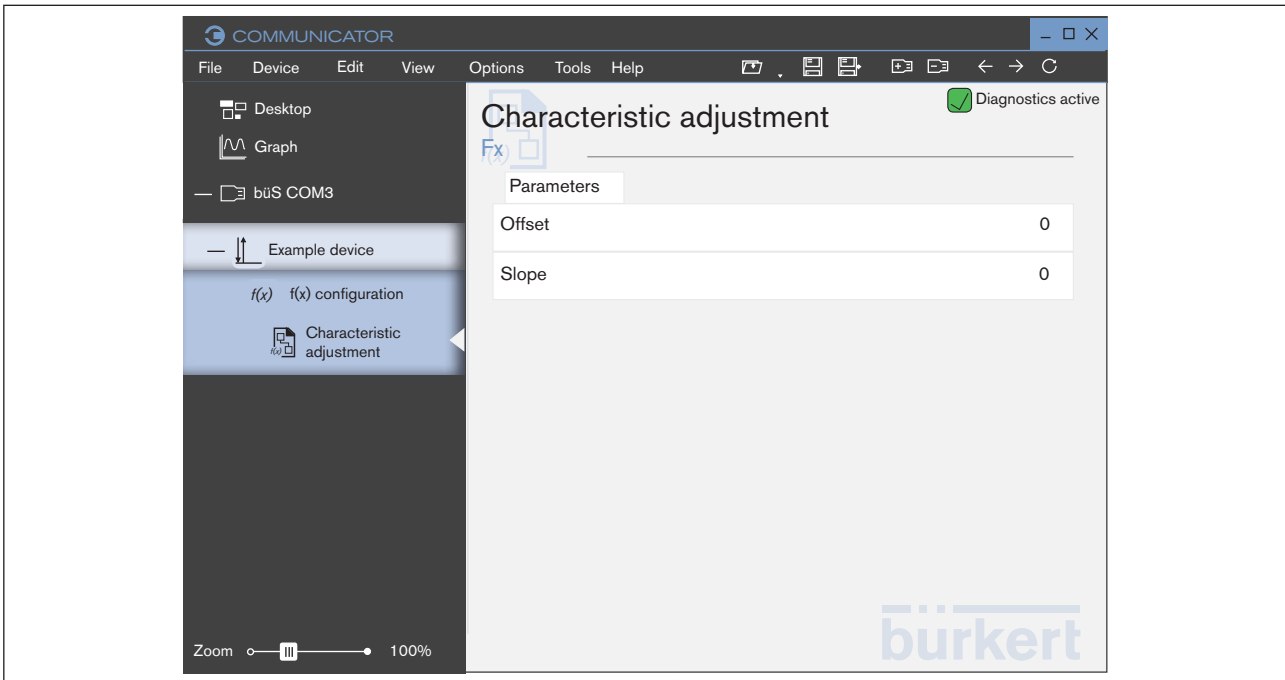

Figure 23: Adjusting parameters

- Select function (in the example: characteristic adjustment) in the **Navigation area**.
- ✔ Parameters are displayed in the application area.
- Click on the required parameters and adjust.
- Confirm with **Apply**.

7 ERROR MESSAGES

7.1 Display of the device status

The device status is represented according to NAMUR NE 107. If several device statuses exist simultaneously, the device status with the highest priority is displayed. The priority is determined by the severity of the deviation from standard operation.

Status display in accordance with NAMUR NE 107		Description	Meaning
Color	red	Failure, error or malfunction	The measured value is invalid due to a malfunction in the device or on its peripheral equipment
	orange	Function check	Work is being carried out on the device; the measured value is therefore not currently valid
	yellow	Out of specification	Ambient conditions or process conditions for the device are outside the specified area. Internal device diagnostics point to problems in the device or the process properties
	blue	Maintenance required	The device is in measuring mode, however a function is briefly restricted
	green	Diagnostics active	Device is operating perfectly. Status changes are indicated in different colors. Messages are transmitted via a message list and any connected fieldbus
	white	Diagnostics inactive	Device is switched on. Statuses are not displayed. Messages are not listed in the message list or transmitted via any connected fieldbus

8 ADDITIONAL INFORMATION

8.1 Licenses

The program editor is a graphical programming system in which the selected blocks allow online monitoring of signals. When the program editor has started, a mask appears with information on all available blocks.



Number of blocks in the program editor for the free version is restricted to 10 blocks. Additional licenses are added by the user.

- License key, order number 567 713



Further information on the issued licenses and the enabled functions can be found in the operating instructions of the Bürkert-Communicator at www.burkert.com.

