

2/2-way solenoid valve for fluids

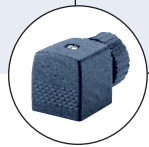

Type 6213 can be combined with...



Type 2508
Cable plug





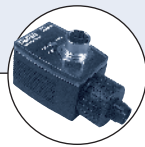

Type 1078
Timer unit



Type 2511
ASI cable plug



Type 8600
Dosing control

- Compact body from brass or stainless steel
- Push-over coil
- Waterhammer-free, low noise
- Diaphragm materials NBR, EPDM, FKM
- Approvals:     

The Type 6213 is a 2/2-way normally closed solenoid valve with a forced coupled diaphragm system. It switches from 1.5 PSI and can be used universally for fluids. For complete opening, a differential pressure of at least 1.5 PSI is necessary.

Power consumption			
Orifice DN [mm]	Inrush AC [VA]	Hold AC [VA/W]	DC [W]
10	34	14/8	10
13	36	14/8	10
20	38	14/8	10
25	160	38/18	–
40	202	38/18	–

Technical data	
Orifice	DN 10 – 40 mm
Body material	Brass, stainless steel 1.4404 (316L)
Inner part of valve	Brass body Stainless steel body
Seal material	NBR, FKM, EPDM
Media	NBR FKM EPDM
Ambient temperature	Max. 131°F (+55°C)
Media temperature	NBR FKM EPDM
Voltage tolerance	±10%
Duty cycle	100% continuous rating
Electrical connection	Tag connector acc. to DIN 43650 Form A for cable plug Type 2508 (see Accessories)
Protection class	IP 65 with cable plug
Installation	As required, preferably with actuator upright
Response times¹⁾	0.1 - 4 seconds (depending on orifice size and differential pressure)

¹⁾ Measured at valve outlet at 87 PSI and 68°F (+20°C)

Opening: pressure build-up 0 to 90%

Closing: pressure decay 100 to 10%

Dimensions [mm]

G Thread			AC coil			DC coil			DC and AC coil		
DN	G	F	B	H	K	B	H	K	C	L (Brass/SS)	M
10	NPT 1/4	12	82.0	32	45	82.5	40	51	37.5	50/55	3.5
	NPT 3/8	12									
	NPT 1/2	14									
13	NPT 1/2	14	95.5	32	45	96.0	40	51	45.0	58/65	3.5
	NPT 3/4	16									
20	NPT 3/4	16	115.5	32	45	116.0	40	51	66.0	80/100	3.5
	NPT 1	18									
25	NPT 1	18	158.5	49	53	158.5	49	53	104.5	95/-	7.0
	NPT 1 1/4	20									
40	NPT 1 1/2	22	179.5	49	53	179.5	49	53	104.5	132/-	7.0
	NPT 2	24									

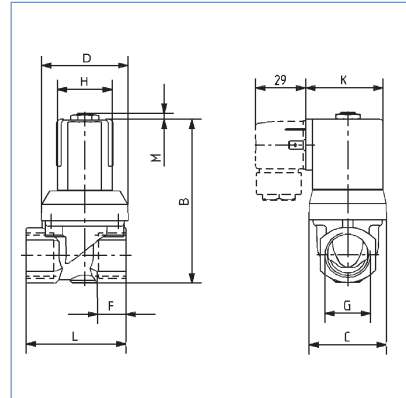

Specifications - ordering chart (other versions on request)

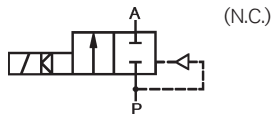

Brass body, NBR seal

U.L. Listed 
with 1/2" conduit plug Type 2509
0-250 V AC/DC

Port Connections [NPT]	Orifice [inch]	C _v	Pressure range [PSI]	Weight [lbs.]	Item no. Voltage / Frequency			
					24/DC	24/60	120/60	240/60
3/8	3/8	2.4	1.5 - 145	0.9	456 534	456 535	456 536	456 537
1/2	3/8	2.4	1.5 - 145	1.2	456 546	456 547	456 548	456 549
1/2	1/2	4.2	1.5 - 145	1.2	456 538	456 539	456 540	456 541
3/4	1/2	4.2	1.5 - 145	2.2	456 550	456 551	456 552	456 553
3/4	3/4	10.5	1.5 - 145	2.2	456 542	456 543	456 544	456 545
1	3/4	10.5	1.5 - 145	3.7	456 554	456 555	456 556	456 557
1	1	12.9	1.5 - 145	3.7	-	457 339	457 340	457 341
1 1/4	1	12.9	1.5 - 145	3.7	-	457 342	457 343	457 344
1 1/2	1 1/2	35.1	1.5 - 145	7.9	-	457 345	457 346	457 347
2	1 1/2	35.1	1.5 - 145	7.9	-	457 348	457 349	457 350

Brass body, FKM seal

Port Connections [NPT]	Orifice [inch]	C _v	Pressure range [PSI]	Weight [lbs.]	Item no. Voltage / Frequency			
					24/DC	24/60	120/60	240/60
3/8	3/8	2.4	1.5 - 145	0.9	456 558	456 559	456 560	456 561
1/2	1/2	4.2	1.5 - 145	1.2	456 562	456 563	456 564	456 565
3/4	3/4	10.5	1.5 - 145	2.2	456 566	456 567	456 568	456 569

Stainless steel body, FKM seal

Port Connections [NPT]	Orifice [inch]	C _v	Pressure range [PSI]	Weight [lbs.]	Item no. Voltage / Frequency			
					24/DC	24/60	120/60	240/60
1/4	3/8	2.4	1.5 - 145	0.9	458 796	458 797	458 798	458 799
3/8	3/8	2.4	1.5 - 145	0.9	458 800	458 801	458 802	458 803
1/2	1/2	4.2	1.5 - 145	1.2	458 804	458 805	458 806	458 807
3/4	3/4	10.5	1.5 - 145	2.2	458 808	458 809	458 810	458 811
1	3/4	10.5	1.5 - 145	3.7	458 812	458 813	458 814	458 815

Specifications – ordering chart (other versions on request) (continued)

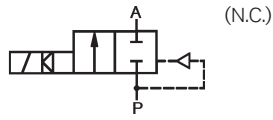

U.L. Recognized 
with standard-cable plug, Type 2508
0–250 V AC/DC

Brass body, NBR seal

Port Connections [NPT]	Orifice [inch]	C _v	Pressure range [PSI]	Weight [lbs.]	Item no. Voltage / Frequency			
					24/DC	24/60	120/60	240/60
1/4	3/8	2.4	1.5 – 145	0.9	458 078	458 079	458 080	458 081
3/8	3/8	2.4	1.5 – 145	0.9	456 439	456 440	456 441	456 442
1/2	3/8	2.4	1.5 – 145	1.2	456 449	456 450	456 451	456 452
1/2	1/2	4.2	1.5 – 145	1.2	458 443	456 444	456 300	456 445
3/4	1/2	4.2	1.5 – 145	2.2	456 453	456 454	456 455	456 456
3/4	3/4	10.5	1.5 – 145	2.2	456 446	456 447	456 301	456 448
1	3/4	10.5	1.5 – 145	3.7	456 457	456 458	456 302	456 659
1	1	12.9	1.5 – 145	3.7	–	457 163	457 164	457 165
1 1/4	1	12.9	1.5 – 145	3.7	–	457 166	457 167	457 168
1 1/2	1 1/2	35.1	1.5 – 145	7.9	–	457 169	457 170	457 171
2	1 1/2	35.1	1.5 – 145	7.9	–	457 172	457 173	457 174

Brass body, FKM seal

Port Connections [NPT]	Orifice [inch]	C _v	Pressure range [PSI]	Weight [lbs.]	Item no. Voltage / Frequency			
					24/DC	24/60	120/60	240/60
1/4	3/8	2.4	1.5 – 145	0.9	458 082	458 083	458 084	458 085
3/8	3/8	2.4	1.5 – 145	0.9	456 460	456 461	456 462	456 463
1/2	1/2	4.2	1.5 – 145	1.2	456 464	456 465	456 466	456 467
3/4	3/4	10.5	1.5 – 145	2.2	456 468	456 469	456 470	456 471

Stainless steel body, FKM seal

Port Connections [NPT]	Orifice [inch]	C _v	Pressure range [PSI]	Weight [lbs.]	Item no. Voltage / Frequency			
					24/DC	24/60	120/60	240/60
1/4	3/8	2.4	1.5 – 145	0.9	458 732	458 733	458 734	458 735
3/8	3/8	2.4	1.5 – 145	0.9	458 736	458 737	458 738	458 739
1/2	1/2	4.2	1.5 – 145	1.2	458 740	458 741	458 742	458 743
3/4	3/4	10.5	1.5 – 145	2.2	458 744	458 745	458 746	458 747
1	3/4	10.5	1.5 – 145	3.7	458 748	458 749	458 750	458 751

Specifications - ordering chart (other versions on request)

U.L. Listed 
with 1/2" conduit plug Type 2509
0-250 V AC/DC

Brass body, EPDM seal

Port Connections [NPT]	Orifice [inch]	C _v	Pressure range [PSI]	Weight [lbs.]	Item no. Voltage / Frequency			
					24/DC	24/60	120/60	240/60
3/8	3/8	2.4	1.5 - 145	0.9	457 187	457 188	457 189	457 190
1/2	1/2	2.4	1.5 - 145	1.2	457 191	457 192	457 193	457 194
3/4	3/4	10.5	1.5 - 145	2.2	457 195	457 196	457 197	457 198
1	1	12.9	1.5 - 145	3.7	-	457 351	457 352	457 353
1 1/4	1	12.9	1.5 - 145	3.7	-	457 354	457 355	457 356
1 1/2	1 1/2	35.1	1.5 - 145	7.9	-	457 357	457 358	457 359
2	1 1/2	35.1	1.5 - 145	7.9	-	457 360	457 361	457 362

Stainless steel body, EPDM seal

Port Connections [NPT]	Orifice [inch]	C _v	Pressure range [PSI]	Weight [lbs.]	Item no. Voltage / Frequency			
					24/DC	24/60	120/60	240/60
1/4	3/8	2.4	1.5 - 145	0.9	458 776	458 777	458 778	458 779
3/8	3/8	2.4	1.5 - 145	0.9	458 780	458 781	458 782	458 783
1/2	1/2	4.2	1.5 - 145	1.2	458 784	458 785	458 786	458 787
3/4	3/4	10.5	1.5 - 145	2.2	458 788	458 789	458 790	458 791
1	3/4	10.5	1.5 - 145	3.7	458 792	458 792	458 794	458 795

U.L. Recognized 
with standard-cable plug, Type 2508
0-250 V AC/DC

Brass body, EPDM seal

Port Connections [NPT]	Orifice [inch]	C _v	Pressure range [PSI]	Weight [lbs.]	Item no. Voltage / Frequency			
					24/DC	24/60	120/60	240/60
1/4	3/8	2.4	1.5 - 145	0.9	458 086	458 087	458 088	458 089
3/8	3/8	2.4	1.5 - 145	0.9	457 175	457 176	457 177	457 178
1/2	1/2	4.2	1.5 - 145	1.2	457 179	457 180	457 181	457 182
3/4	3/4	10.5	1.5 - 145	2.2	457 183	457 184	457 185	457 186
1	1	12.9	1.5 - 145	3.7	457 984	457 234	457 235	457 236
1 1/4	1	12.9	1.5 - 145	3.7	457 985	457 237	457 238	457 239
1 1/2	1 1/2	35.1	1.5 - 145	7.9	457 986	457 240	457 241	457 242
2	1 1/2	35.1	1.5 - 145	7.9	457 987	457 243	457 244	457 245

Stainless steel body, EPDM seal

Port Connections [NPT]	Orifice [inch]	C _v	Pressure range [PSI]	Weight [lbs.]	Item no. Voltage / Frequency			
					24/DC	24/60	120/60	240/60
1/4	3/8	2.4	1.5 - 145	0.9	458 712	458 713	458 714	458 715
3/8	3/8	2.4	1.5 - 145	0.9	458 716	458 717	458 718	458 719
1/2	1/2	4.2	1.5 - 145	1.2	458 720	458 721	458 722	458 723
3/4	3/4	10.5	1.5 - 145	2.2	458 724	458 725	458 726	458 727
1	3/4	10.5	1.5 - 145	3.7	458 728	458 729	458 730	458 731