

Insertion fitting for flow or analytical measurement

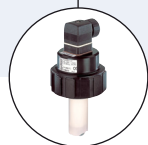

- Universal fitting for Insertion measuring device in pure, aggressive or contaminated liquids
- Large range of process connections: DN06 to DN400 in PVC, PP, PVDF, PE, stainless steel, brass
- Transmitter available for:
 - Indication, Monitoring, Transmitting
 - On/Off control, Batch control

Type S020 can be combined with...



Type 8020
Paddle wheel
flowmeter



Type 8025
Paddle wheel
flowmeter



Type 8026
Paddle wheel
flowmeter

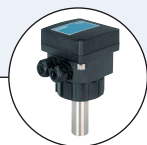

Type 8041
Electromagnetic
flowmeter



Type 8045
Electromagnetic
flowmeter



Type 8228
Inductive conductivity
meter

The fitting can be used to connect any Insertion device for a measurement in the pipe. e.g. for flow, pH, oxidation reduction potential (O.R.P) and conductivity measurement.

The fitting is available for paddle wheel and electromagnetic flowmeters and analytical measurement devices having a G 2" or a clamp connection.

General data	
Pipe diameter	
G 2" flowmeter connection	DN06...DN400 ¹⁾
Clamp flowmeter connection	DN32...DN100
Fitting process connections	
Metal	Internal or external thread, weld ends, clamp or flange
Plastic	True union, spigot or external thread
Materials	
G 2" flowmeter connection	
Seal	FKM or EPDM
Body & adapter	Brass (CuZn39Pb2) & stainless steel (316L - 1.4404), all in stainless steel (316L - 1.4404) or all in PVC, PP, PVDF, PE
Clamp flowmeter connection	Stainless steel 316L
Surface finish	
Clamp flowmeter connection	Ra < 0.8 µm
Fluid data	
Fluid temperature²⁾	0...+50 °C (+32...+122 °F) for fitting in PVC 0...+80 °C (+32...+176 °F) for fitting in PP -15...+100 °C (+5...+212 °F) for fitting in PVDF -15...+160 °C (+5...+320 °F) for fitting in stainless steel or brass
Fluid pressure (max.)²⁾	
Metal	PN16
Plastic	PN10
Environment	
Ambient temperature	Temperature limits may depend on the inserted device. Refer to the relevant data sheet or instruction manual for more details

¹⁾ Combination between fitting and measuring device is sometimes restricted to some DN (see diagram: combining the S020 with a measuring device on next page)

²⁾ Temperature and pressure limits may depend on the inserted device. Refer to the relevant data sheet or instruction manual and the pressure/temperature diagram of the fluid on next page. If the temperature or pressure ranges given for the adapter and the inserted device are different, use the most restrictive range

Standards, directives and certifications	
Standards and directives C€	The applied standards, which verify conformity with the EU Directives, can be found on the EU Type Examination Certificate and/or the EU Declaration of conformity (if applicable)
Pressure	Complying with Article 4, Paragraph 1 of 2014/68/EU directive*
Certificates	Inspection certificate 3.1 (acc. to EN-ISO 10204); Test report 2.2 (acc. to EN-ISO 10204); Certification of Conformity for the surface Quality (DIN4762-DIN4768-ISO/4287/1); 3 points Flow calibration certificate; FDA (with EPDM seal) - stainless steel fitting only

* The device conforms to Article 4, Paragraph 1 of the Pressure Equipment Directive 2014/68/EU under the following conditions:
 ■ **Device used on a pipe** (PS = maximum admissible pressure; DN = nominal diameter of the pipe).

Type of fluid	Conditions
Fluid group 1, Article 4, Paragraph 1.c.i	DN ≤ 25
Fluid group 2, Article 4, Paragraph 1.c.i	DN ≤ 32 or PS*DN ≤ 1000
Fluid group 1, Article 4, Paragraph 1.c.ii	DN ≤ 25 or PS*DN ≤ 2000
Fluid group 2, Article 4, Paragraph 1.c.ii	DN ≤ 200 or PS ≤ 10 or PS*DN ≤ 5000

Pressure/temperature diagram

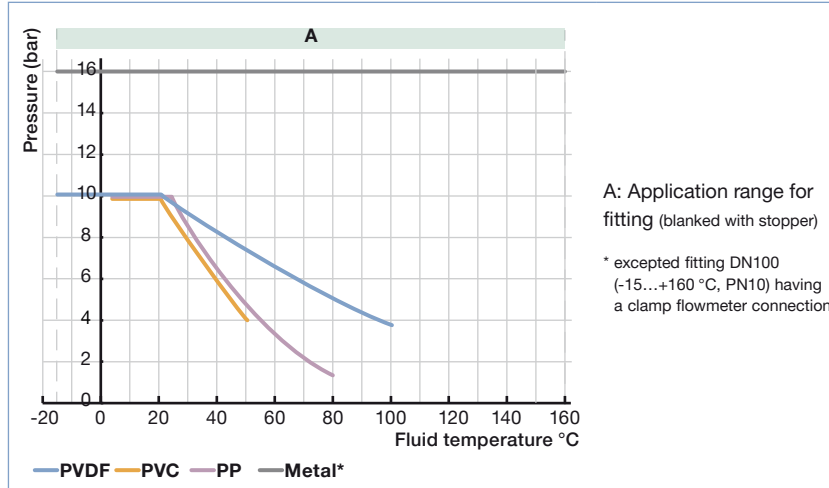

! This table is independent of the chemical compatibility of the material and fluid. Please make sure the device materials are compatible with the fluid.

Combining the S020 with a measuring device for flow rate, pH or O.R.P., conductivity measurement

	DN06	DN32	DN50	DN65	DN100	DN200	DN350	DN400
Available S020 fittings								
T-fitting with G 2" flowmeter connection	[Bar]							
T-fitting or welding socket with Clamp flowmeter connection		[Bar]						
Welding socket			[Bar]					
Fusion spigot			[Bar]					
Screw-on					[Bar]			
Saddle				[Bar]				
Flow rate measurement	DN06	DN15	DN20*	DN32	DN50	DN100	DN200	DN400
8020 - 8025 - 8026 - 8041 - 8045 with G 2" connection		[Bar]		[Bar]		[Bar]		
8041 - 8045 with clamp connection				[Bar]				
pH or O.R.P. measurement		[Bar]		[Bar]				
8200/8203		[Bar]		[Bar]				
Conductivity measurement		[Bar]		[Bar]				
8220 - 8223 - 8228		[Bar]		[Bar]				

* Except fittings with external threads acc. to SMS 1145, weld ends acc. to SMS 3008, BS 4825-1/ASME BPE/DIN 11866 series C or DIN 11850 series 2/DIN 11866 series A/ DIN EN 10357 series A, Clamp acc. to SMS 3017, BS 4825-3/ASME BPE, DIN 32676 series A for 8020, 8025, 8026
 ** See Note on each fitting dimensions diagram
 *** Only use plastic fitting in analytical version with true union acc. to DIN 8063 (PVC), to DIN 16962 (PP) or to ISO 10931 (PVDF)
 For further details about the various combination possibilities (measuring device and fitting), please consult the measuring device related data sheet.

DTS 1000011768 EN Version: AF Status: RL (released | freigegeben | valide) printed: 05.10.2018

Installation

Flow measurement:

Minimum straight upstream and downstream distances must be observed. According to the pipe's design, necessary distances can be bigger or use a flow conditioner to obtain the best accuracy. For more information, please refer to EN ISO 5167-1.

EN ISO 5167-1 prescribes the straight inlet and outlet distances that must be complied with when installing fittings in pipe lines in order to achieve calm flow conditions. The most important layouts that could lead to turbulence in the flow are shown below, together with the associated prescribed minimum inlet and outlet distances.

These ensure calm, problem-free measurement conditions at the measurement point.

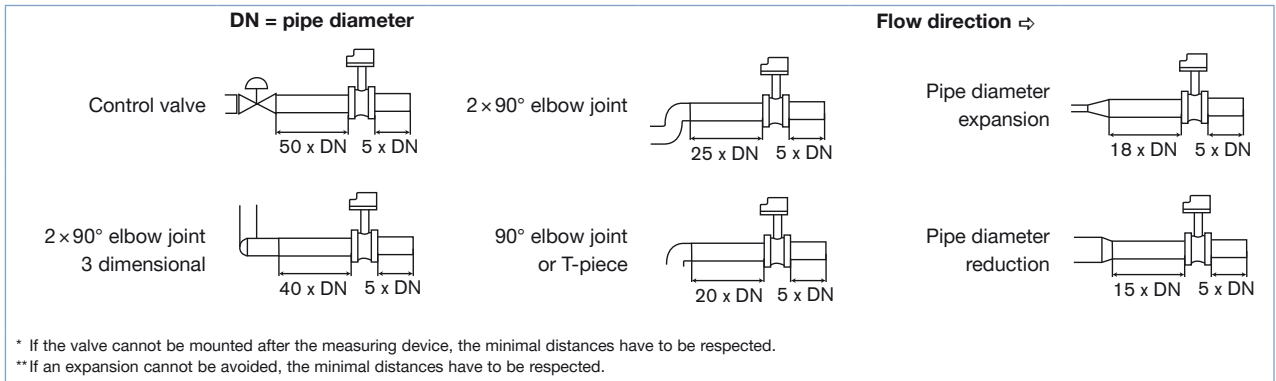

The device can be installed into either horizontal or vertical pipes.

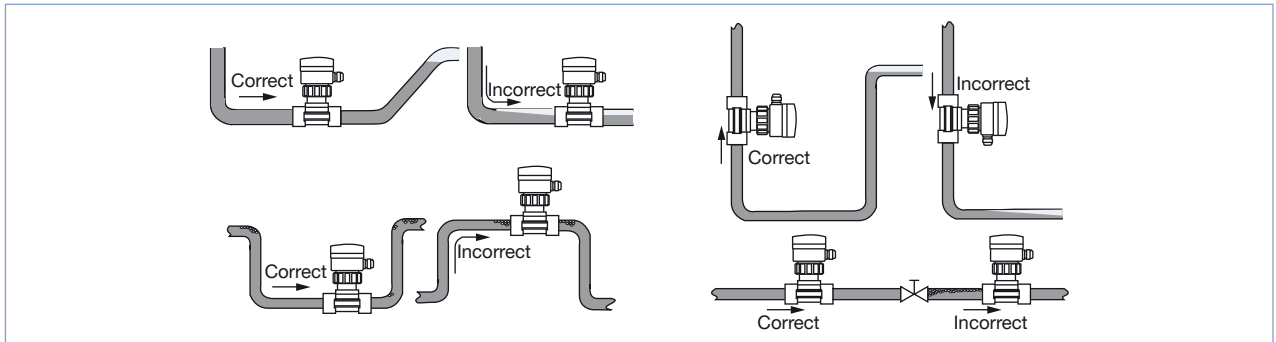

Analytical measurement:

For pH and O.R.P. measurements, we recommend a "U"-form bypass installation to ensure that the electrode is maintained in a wet condition and enable the customer to calibrate the unit without stopping the whole process or to use the special designed measuring chamber. The specially designed measuring chamber enables to install all pH-, O.R.P.-, conductivity- meters in all pipe systems, either directly in the main stream or in a by-pass line. Additionally it enables to keep the electrode always wet and isolates it easily from the main stream for calibration purposes.

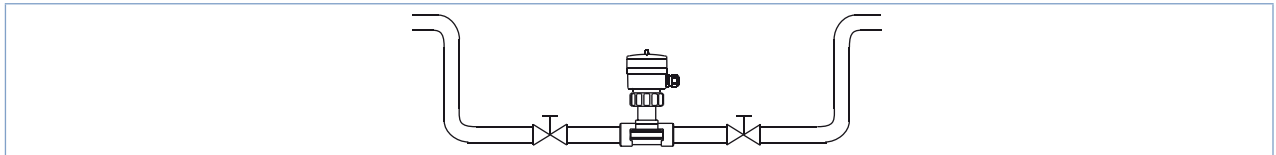

NOTE: Pressure and temperature ratings must be in accordance to the selected fitting material. The suitable pipe size is selected using the diagram Flow rate/Velocity/DN.

Diagram Flow rate/Velocity/DN

Example:

- Flow: 10 m³/h
- Ideal flow velocity: 2...3 m/s

For these specifications, the diagram indicates a pipe size of DN40 [or DN50 for (*) mentioned fittings]

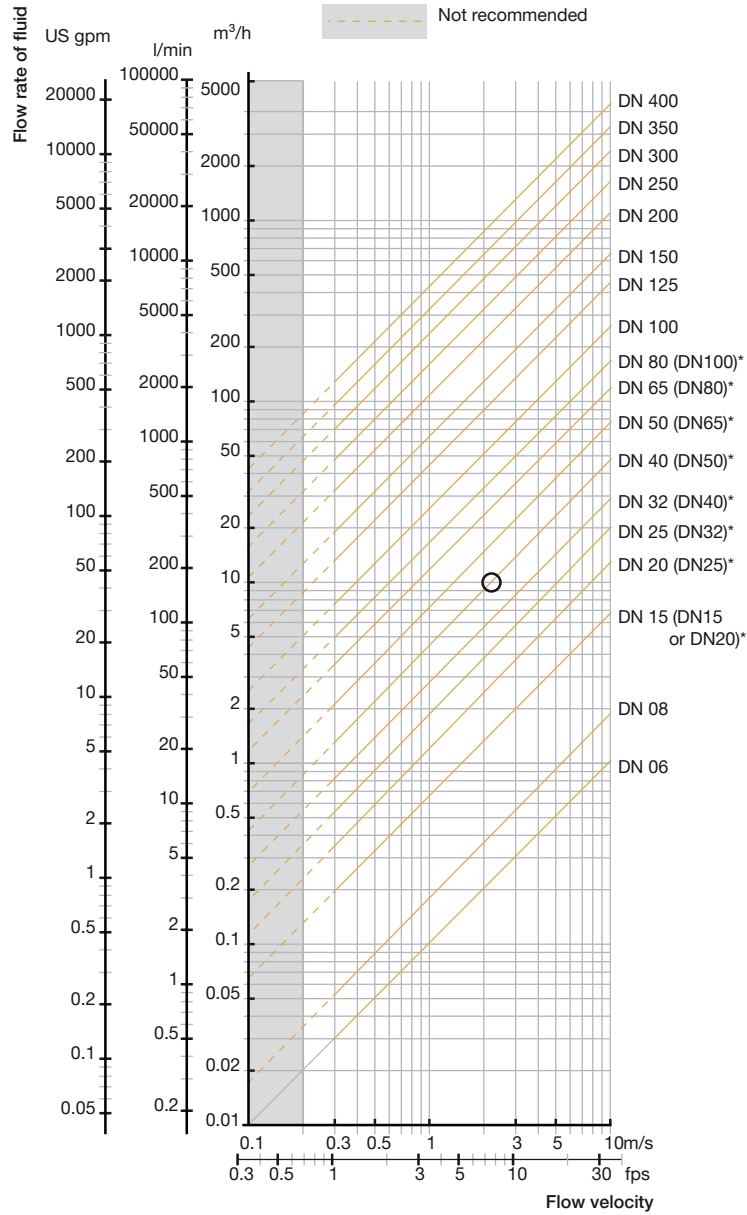

* for following fittings with:

- external thread acc. to SMS 1145
- weld end acc. to SMS 3008, BS 4825-1/ASME BPE/DIN 11866 series C or DIN 11850 series 2/DIN 11866 series A/DIN EN 10357 series A
- Clamp acc. to SMS 3017, BS 4825-3/ASME BPE or DIN 32676 series A

Dimensions

Fitting for flowmeter with G 2" connection

Internal thread process connection

G, NPT or Rc

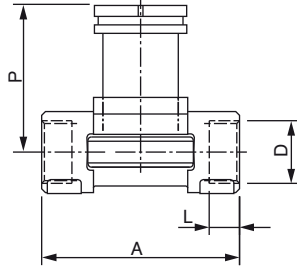
in stainless steel (316L - 1.4404) or
brass (CuZn39Pb2)**NOTE:**

short sensor version

DN	P	A	D	L
[mm]	[mm]	[mm]	[inch]	[mm]
15	80.3	84.0	G 1/2 NPT 1/2 Rc 1/2	16.0 17.0 15.0
20	77.8	94.0	G 3/4 NPT 3/4 Rc 3/4	17.0 18.3 16.3
25	78.0	104.0	G 1 NPT 1 Rc 1	23.5 18.0 18.0
32	81.6	119.0	G 1 1/4 NPT 1 1/4 Rc 1 1/4	23.5 21.0 21.0
40	85.4	129.0	G 1 1/2 NPT 1 1/2 Rc 1 1/2	23.5 20.0 19.0
50	91.5	148.5	G 2 NPT 2 Rc 2	27.5 24.0 24.0

External thread process connection

G,

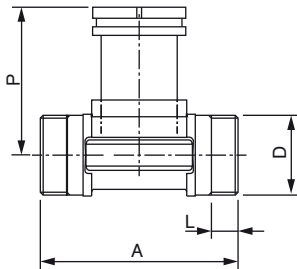
in stainless steel (316L - 1.4404),
brass (CuZn39Pb2),
PVC (only DN6 and DN8)**NOTE:**

short sensor version

DN	P	A	D	L
[mm]	[mm]	[mm]	[inch]	[mm]
06	75.3	90.0	G 1/2	-
08	75.3	90.0	G 1/2	-
15	80.3	84.0	G 3/4	-
20	77.8	94.0	G 1	-
25	78.0	104.0	G 1 1/4	-
32	81.6	119.0	G 1 1/2	-
40	85.4	129.0	-	M 55x2
50	91.5	148.5	-	M 64x2

External thread process connection

SMS 1145,

in stainless steel (316L - 1.4404)

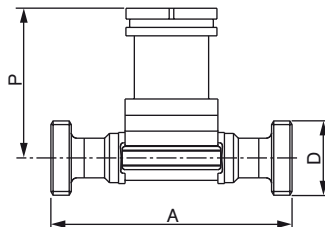
**NOTE:**

short sensor version

DN	P	A	D
[mm]	[mm]	[mm]	
25	77.8	130	Rd 40 x 1/6"
40	81.6	164	Rd 60 x 1/6"
50	85.4	173	Rd 70 x 1/6"

Dimensions, continued

Fitting for flowmeter with G 2" connection

Weld end process connection

EN ISO 1127/ISO 4200/DIN 11866 series B,
SMS 3008 or
BS 4825-1/ASME BPE/DIN 11866 series C
in stainless steel (316L - 1.4404)

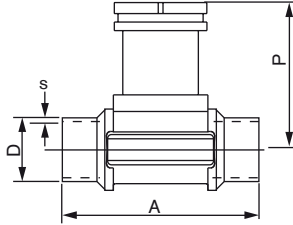

NOTE:
short sensor version

DN	P	A	Standard	D	s
[mm]	[mm]	[mm]		[mm]	[mm]
15	80.3	84.0	EN ISO 1127/ISO 4200/DIN 11866 series B	21.30	1.60
	-	-	SMS 3008	-	-
	-	-	ASME BPE/DIN 11866 series C	-	-
20	77.8	94.0	EN ISO 1127/ISO 4200/DIN 11866 series B	26.9	1.60
	-	-	SMS 3008	-	-
	83.3	84.0	ASME BPE/DIN 11866 series C	19.05	1.65
25	78.0	104.0	EN ISO 1127/ISO 4200/DIN 11866 series B	33.70	2.00
	77.8	94.0	SMS 3008	25.00	1.20
	77.8	94.0	BS 4825-1/ASME BPE/DIN 11866 series C	25.40	1.65
32	81.6	119.0	EN ISO 1127/ISO 4200/DIN 11866 series B	42.40	2.00
	-	-	SMS 3008	-	-
	78.0	104.0	BS 4825-1/ASME BPE/DIN 11866 series C	32.00	1.65
40	85.4	129.0	EN ISO 1127/ISO 4200/DIN 11866 series B	48.30	2.00
	81.6	119.0	SMS 3008	38.00	1.20
	81.6	119.0	BS 4825-1/ASME BPE/DIN 11866 series C	38.10	1.65
50	91.5	148.5	EN ISO 1127/ISO 4200/DIN 11866 series B	60.30	2.60
	85.4	128.0	SMS 3008	51.00	1.20
	85.4	128.0	BS 4825-1/ASME BPE/DIN 11866 series C	50.80	1.65
65	-	-	EN ISO 1127/ISO 4200/DIN 11866 series B	-	-
	91.5	147.0	SMS 3008	63.50	1.60
	91.5	147.0	BS 4825-1/ASME BPE/DIN 11866 series C	63.50	1.65

Clamp process connection

DIN 32676 series B,
SMS 3017* or BS 4825-3/ASME BPE*
in stainless steel (316L - 1.4404)

* Available with internal surface finish Ra = 0.8 µm

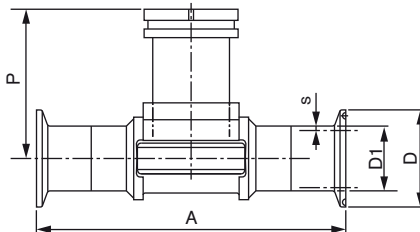

NOTE:
short sensor version

DN	P	A	Standard	D1	s	D
[mm]	[mm]	[mm]		[mm]	[mm]	[mm]
15	80.3	130	DIN 32676 series B ¹⁾	21.30	1.6	34.0
	-	-	SMS 3017	-	-	-
	-	-	ASME BPE	-	-	-
20	77.8	150	DIN 32676 series B	26.90	1.6	50.5
	-	-	SMS 3017	-	-	-
	80.3	119	ASME BPE	19.05	1.65	25.0
25	78.0	160	DIN 32676 series B	33.70	2.0	50.5
	77.8	129	SMS 3017	25.0	1.2	50.5
	77.8	129	BS 4825-3/ASME BPE	25.40	1.65	50.5
32	81.6	180	DIN 32676 series B	42.40	2.0	50.5
	-	-	SMS 3017	-	-	50.5
	-	-	BS 4825-3/ASME BPE	-	-	-
40	85.4	200	DIN 32676 series B	48.30	2.0	64.0
	81.6	161	SMS 3017	38.00	1.2	50.5
	81.6	161	BS 4825-3/ASME BPE	38.10	1.65	50.5
50	91.5	230	DIN 32676 series B	60.30	2.0	77.5
	85.4	192	SMS 3017	51.00	1.2	64.0
	85.4	192	BS 4825-3/ASME BPE	50.8	1.65	64.0
65	-	-	DIN 32676 series B	-	-	-
	91.5	216	SMS 3017	63.50	1.65	77.5
	91.5	216	BS 4825-3/ASME BPE	63.50	1.65	77.5

¹⁾ similar to DIN 32676 series B but with clamp 34.0

Dimensions, continued

Fitting for flowmeter with G 2" connection

Flange process connection

EN1092-1/B1/PN16, ANSI B16-5
in stainless steel (316L - 1.4404)

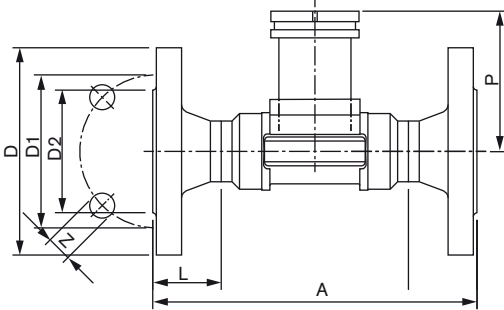

DN	P	A	Standard	L	Z	D2	D1	D
[mm]	[mm]	[mm]		[mm]	[mm]	[mm]	[mm]	[mm]
15	80.3	130	EN	23.5	4 × 14.0	45.0	65.0	95.0
		130	ANSI					
20	77.8	150	EN	28.5	4 × 14.0	58.0	75.0	105.0
		150	ANSI					
25	78.0	160	EN	28.5	4 × 14.0	68.0	85.0	115.0
		160	ANSI					
32	81.6	180	EN	31.0	4 × 18.0	78.0	100.0	140.0
		180	ANSI					
40	85.4	200	EN	36.0	4 × 18.0	88.0	110.0	150.0
		200	ANSI					
50	91.5	230	EN	41.0	4 × 18.0	102.0	125.0	165.0
		230	ANSI					

NOTE:

short sensor version

True union process connection

DIN 8063, ASTM D 1785/76 or JIS K in PVC,
DIN 16962 in PP or
ISO 10931 in PVDF

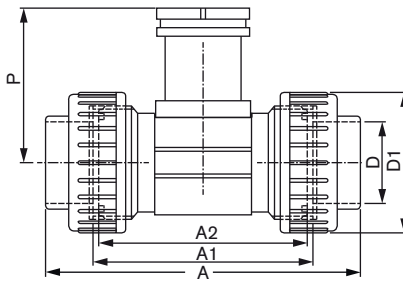

DN	P	A	Standard	A1	A2	D	D1
[mm]	[mm]	[mm]		[mm]	[mm]	[mm]	[mm]
15	80.4	128.0	DIN/ISO	96	90	20.00	43
		130.0	ASTM	96	90	21.30	43
		129.0	JIS	96	90	18.40	43
15*	81.4	148.0	DIN/ISO	116	110	20.00	74
20	77.8	144.0	DIN/ISO	106	100	25.00	53
		145.6	ASTM	106	100	26.70	53
		145.0	JIS	106	100	26.45	53
20*	81.4	154.0	DIN/ISO	116	110	25.00	74
25	78.0	160.0	DIN/ISO	116	110	32.00	60
		161.4	ASTM	116	110	33.40	60
		161.0	JIS	116	110	32.55	60
25*	81.4	160.0	DIN/ISO	116	110	32.00	74
32	81.4	168.0	DIN/ISO	116	110	40.00	74
		170.0	ASTM			42.20	
		169.0	JIS			38.60	
40	85.2	188.0	DIN/ISO	127	120	50.00	83
		190.2	ASTM			48.30	
		190.0	JIS			48.70	
50	91.5	212.0	DIN/ISO	136	130	63.00	103
		213.6	ASTM			60.30	
		213.0	JIS			60.80	

* Analytical version

NOTE:

short sensor version

Dimensions, continued

Fitting for flowmeter with G 2" connection

Spigot process connection

DIN 8063 in PVC
 DIN 16962 in PP or
 ISO 10931 in PVDF

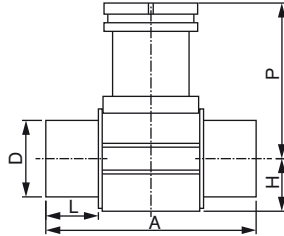

NOTE:
 short sensor version

DN	P	A	Standard	L	D	H
[mm]	[mm]	[mm]		[mm]	[mm]	[mm]
15	80.4	90	DIN 8063	16.5	20	17.5
		85	DIN 16962	14.0		
		85	ISO 10931	14.0		
20	77.8	100	DIN 8063	20.0	25	17.5
		92	DIN 16962	16.0		
		92	ISO 10931	16.0		
25	78.0	110	DIN 8063	23.0	32	21.5
		95	DIN 16962	18.0		
		95	ISO 10931	18.0		
32	81.4	110	DIN 8063	27.5	40	27.5
		100	DIN 16962	20.0		
		100	ISO 10931	20.0		
40	85.2	120	DIN 8063	30.0	50	31.5
		106	DIN 16962	23.0		
		106	ISO 10931	23.0		
50	91.5	130	DIN 8063	37.0	63	39.5
		110	DIN 16962	27.0		
		110	ISO 10931	27.0		

Welding socket with radius

in stainless steel (316L - 1.4404)

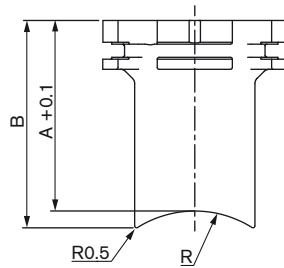

NOTE:
 sensor version:
 - short for DN50...DN200
 - long for DN250...DN350

DN	A	B	R
[mm]	[mm]	[mm]	[mm]
50	56.6	61.6	30.2
65	54.5	58.6	36.7
80	53.1	56.4	44.5
100	50.7	53.2	57.2
125	48.2	50.3	70.7
150	45.7	47.4	84.2
200	41.0	42.3	109.6
250	73.6	74.7	136.6
300	67.8	68.7	162.0
350	63.9	64.7	177.8

Saddle

in PP & PVC

Body material: PP & PVC adapter
 Seal material: EPDM

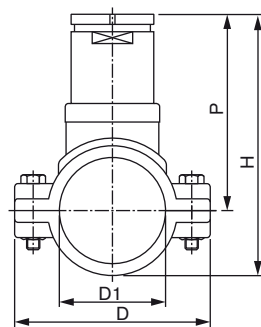

NOTE:
 long sensor version

DN	P	H	D	D1
[mm]	[mm]	[mm]	[mm]	[mm]
50	116.0	155	116	63
65	115.0	160	129	75
80	119.0	171	144	90
100	124.0	187	166	110
110	120.0	191	181	125
125	127.0	205	196	140
150	137.0	225	216	160
180	161.0	271	266	200
200	173.0	291	290	225

Dimensions, continued

Fitting for flowmeter with G 2" connection

Fusion spigot
in PE, PP or PVDF

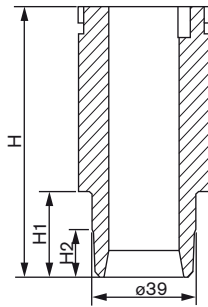

NOTE:
sensor version:
- short for DN65...DN100
- long for DN125...DN400

DN [mm]	H [mm]	Materials	H1 [mm]	H2 [mm]
65	72.5	PE	13.0	-
		PP	13.0	-
		PVDF	10.4	-
80	72.5	PE	15.6	-
		PP	15.6	-
		PVDF	12.5	-
100	72.5	PE	19.0	5.0
		PP	19.0	5.0
		PVDF	15.2	6.0
125	102.0	PE	24.2	8.0
		PP	-	-
		PVDF	-	-
150	102.0	PE	27.7	10.0
		PP	27.7	10.0
		PVDF	-	-
200	102.0	PE	38.9	16.0
		PP	38.9	16.0
		PVDF	-	-
250	102.0	PE	48.4	21.0
		PP	48.4	21.0
		PVDF	-	-
300	102.0	PE	54.5	24.0
		PP	54.5	24.0
		PVDF	-	-
350	102.0	PE	61.3	28.0
		PP	61.3	28.0
		PVDF	-	-
400	102.0	PE	69.1	31.5
		PP	-	-
		PVDF	-	-

Screw-on
DN100...400
in PVC, PP, PE

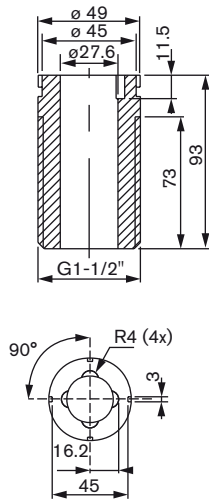

NOTE:
long sensor version

Measuring chamber (only for Analytical measuring device)

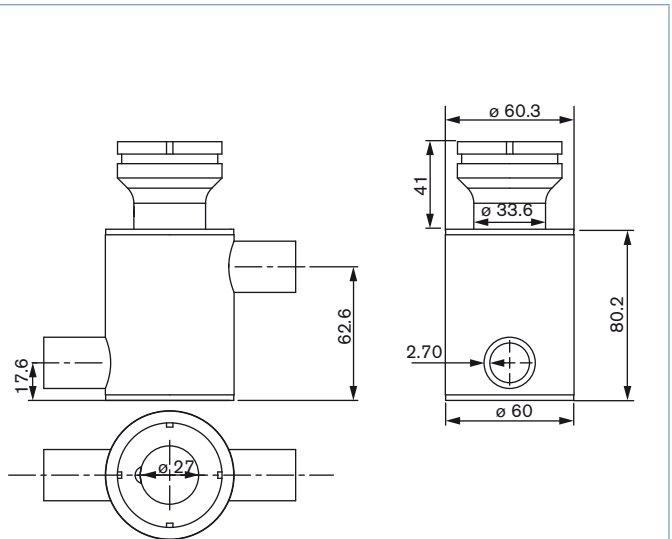

NOTE:
Materials: stainless steel 316L - 1.4404
Pipe connection: G 1/2"

Dimensions, continued

Fitting for flowmeter with clamp connection

Weld end process connection

SMS 3008, BS 4825-1/ASME BPE/DIN 11866 series C
or DIN 11850 series 2/DIN 11866 series A/
DIN EN 10357 series A
in stainless steel 316L

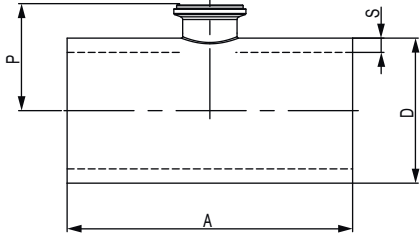

DN	P	A	Standard	D	s
[mm]	[mm]	[mm]		[mm]	[mm]
40	42.5	140	SMS 3008	38	1.2
	43.7	120.6	ASME BPE/DIN 11866 series C	38.1	1.65
	44.3	120	DIN 11850 series 2/DIN 11866 series A/ DIN EN 10357 series A	41	1.5
50	49.3	164	SMS 3008	51	1.2
	50.6	146	BS 4825-1/ASME BPE/DIN 11866 series C	50.8	1.65
	50.8	160	DIN 11850 series 2/DIN 11866 series A/ DIN EN 10357 series A	53	2
65	54.4	210	SMS 3008	63.5	1.6
	55.4	158.8	BS 4825-1/ASME BPE/DIN 11866 series C	63.5	1.65
	59.6	210	DIN 11850 series 2/DIN 11866 series A/ DIN EN 10357 series A	70	2
80	60.7	220	SMS 3008	76.1	1.6
	62	171.5	BS 4825-1/ASME BPE/DIN 11866 series C	76.2	1.65
	67.3	260	DIN 11850 series 2/DIN 11866 series A/ DIN EN 10357 series A	85	2
100	73.8	209.6	BS 4825-1/ASME BPE/DIN 11866 series C	101.6	2.11
	77.1	310	DIN 11850 series 2/DIN 11866 series A/ DIN EN 10357 series A	104	2

Welding socket

in stainless steel 316L

①

SMS 3008 or
DIN 11850 series 2/DIN 11866 series A/DIN EN 10357
series A

②

BS 4825-1/ASME BPE/DIN 11866 series C

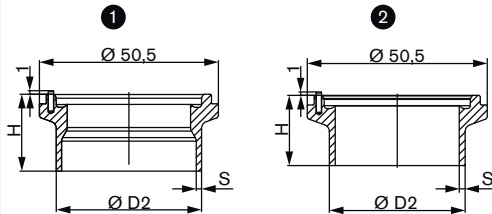

DN	Standard	H	S	D2
[mm]		[mm]	[mm]	[mm]
40	SMS 3008	21.7	1.2	38
	ASME BPE/DIN 11866 series C	23.7	1.65	38.1
	DIN 11850 series 2/DIN 11866 series A/ DIN EN 10357 series A	21.7	1.5	41
50	SMS 3008	21.7	1.2	38
	BS 4825-1/ASME BPE/DIN 11866 series C	23.7	1.65	38.1
	DIN 11850 series 2/DIN 11866 series A/ DIN EN 10357 series A	21.7	1.5	41
65	SMS 3008	19.7	1.2	38
	BS 4825-1/ASME BPE/DIN 11866 series C	19.7	1.65	38.1
	DIN 11850 series 2/DIN 11866 series A/ DIN EN 10357 series A	21.7	1.5	41
80	SMS 3008	19.7	1.2	38
	BS 4825-1/ASME BPE/DIN 11866 series C	19.7	1.65	38.1
	DIN 11850 series 2/DIN 11866 series A/ DIN EN 10357 series A	21.7	1.5	41
100	BS 4825-1/ASME BPE/DIN 11866 series C	19.7	1.65	38.1
	DIN 11850 series 2/DIN 11866 series A/ DIN EN 10357 series A	19.7	1.5	41

Ordering chart

Fitting DN6...DN65 for flowmeter with G 2" connection

Port connection	Seal	Standard	Article no								
			DN06 - 1/2"	DN08 - 1/2"	DN15	DN20	DN25	DN32	DN40	DN50	DN65
Brass body & stainless steel adapter - T-fitting - Medium temperature max. 160 °C, PN16											
Internal thread	FKM	G	-	-	428712	428713	428714	428715	428716	428717	-
		NPT	-	-	428718	428719	428720	428721	428722	428723	-
		Rc	-	-	428724	428725	428726	428727	428728	428729	-
External thread	FKM	G	-	-	428730	428731	428732	428733	428734	428735	-
Stainless steel body & stainless steel adapter - T-fitting - Medium temperature max. 160 °C, PN16											
Internal thread	FKM	G	-	-	428736	428737	428738	428739	428740	428741	-
		NPT	-	-	428742	428743	428744	428745	428746	428747	-
		Rc	-	-	428748	428749	428750	428751	428752	428753	-
External thread	FKM	G	552434	552432	428754	428755	428756	428757	428758	428759	-
	EPDM	SMS 1145	-	-	-	-	443317	-	443318	443319	-
Weld end	FKM	EN ISO 1127/ ISO 4200/DIN 11866 series B	-	-	428760	428761	428762	428763	428764	428765	-
	EPDM	SMS 3008	-	-	-	-	443309	-	443310	443311	443944 ³⁾
		BS 4825-1/ ASME BPE/DIN 11866 series C	-	-	-	443734	443735	443736	443942	443943	443944
Clamp	FKM	DIN 32676 series B	-	-	428766 ¹⁾	428767	428768	428769	428770	428771	-
	EPDM	SMS 3017	-	-	-	-	443313	-	443314	443315	443969 ³⁾
		SMS 3017*	-	-	-	-	443957	-	443958	443959	443974 ³⁾
		BS 4825-3/ ASME BPE	-	-	-	443965	443966	-	443967	443968	443969
		BS 4825-3/ ASME BPE*	-	-	-	443970	443971	-	443972	443973	443974
Flange	FKM	EN 1092-1/B1/PN16	-	-	428772	428773	428774	428775	428776	428777	-
		ANSI B16-5	-	-	428778	428779	428780	428781	428782	428783	-
PVC & PVC adapter - T-fitting - Medium temperature max. 50 °C, PN10											
True union	FKM	DIN 8063	-	-	428670	428671	428672	428673	428674	428675	-
		ASTM D 1785/76	-	-	428682	428683	428684	428685	428686	428687	-
		JIS K	-	-	429078	429079	429080	429081	429082	429083	-
Spigot	FKM	DIN 8063	-	-	428676	428677	428678	428679	428680	428681	-
External thread	FKM	G	552561	550062	-	-	-	-	-	-	-
Analytical true union	FKM	DIN 8063	-	-	430837	430838	430839	428673	428674	428675	-
PP & PP adapter - T-fitting - Medium temperature max. 80 °C, PN10											
True union	FKM	DIN 16962	-	-	428688	428689	428690	428691	428692	428693	-
Spigot	FKM	DIN 16962	-	-	428694	428695	428696	428697	428698	428699	-
Analytical true union	FKM	DIN 16962	-	-	430840	430841	430842	428691	428692	428693	-
PVDF & PVDF adapter - T-fitting - Medium temperature max. 100 °C, PN10											
True union	FKM	ISO 10931	-	-	428700	428701	428702	428703	428704	428705	-
Spigot	FKM	ISO 10931	-	-	428706	428707	428708	428709	428710	428711	-
Analytical true union	FKM	ISO 10931	-	-	430843	430844	430845	428703	428704	428705	-

* internal surface finish Ra = 0.8 µm

¹⁾ Refer to Clamp with D dimensions of 34 mm (see dimension table on page 6)²⁾ DN20 only available in ASME BPE³⁾ Please refer to ASME BPE

Further versions on request



Port connection

Weld ends DIN 11850 series 2/DIN 11866 series A/ DIN EN 10357 series A
Clamp DIN 32676 series A

Ordering chart

Fitting DN50...DN400 for flowmeter with G 2" connection

Port connection	Article no.										
	DN50	DN65	DN80	DN100	DN125	DN150	DN200	DN250	DN300	DN350	DN400
Stainless steel - welding socket with radius - Medium temperature max. 160 °C, PN16											
Welding socket	418111	418112	418113	418114	418115	418116	418117	418756	420070	416637	-
PVC - Screw-on fitting - Medium temperature max. 50 °C, PN10											
Screw-on	-	-	-	418170	418170	418170	418170	-	-	-	-
PVDF - Fusion spigot - Medium temperature max. 100 °C, PN10											
Fusion spigot	-	418658	418659	418660	-	-	-	-	-	-	-
Analytical fusion spigot	-	418660	418660	418660	-	-	-	-	-	-	-
PE - Fusion spigot or screw-on fitting - Medium temperature max. 70 °C, PN10											
Fusion spigot	-	418642	418643	418644	418590	418645	418646	418647	418648	418649	418598
Screw-on	-	-	-	436489	436489	436489	436489	436489	436489	436489	436489
Analytical fusion spigot	-	418644	418644	418644	-	-	-	-	-	-	-
PP - Fusion spigot or screw-on fitting - Medium temperature max. 80 °C, PN10											
Fusion spigot	-	418650	418651	418652	-	418653	418654	418655	418656	418657	-
Screw-on	-	-	-	436488	436488	436488	436488	436488	436488	436488	436488
Analytical fusion spigot	-	418652	418652	418652	-	-	-	-	-	-	-

Port connection	Seal	Article no.								
		DN50	DN65	DN80	DN100	DN110	DN125	DN150	DN180	DN200
PP & PVC adapter - Saddle - Medium temperature max. 60 °C, PN10 (for PVC or PP pipe)										
Saddle	EPDM	425138	425139	425140	425141	425142	425143	425144	433873	425416

* internal surface finish Ra = 0,8 µm

¹ DN20 only available in ASME BPE

Fitting DN32...DN100 for flowmeter with clamp connection (Type 8041/8045 clamp version)

Port connection	Standard	Article no.					
		DN32 PN16	DN40 PN16	DN50 PN16	DN65 PN16	DN80 PN16	DN100 PN10
Stainless steel T-fitting - Medium temperature max. 160 °C							
Weld end	SMS 3008	-	564915	564916	564917	564918	**
	BS 4825-1/ASME BPE/DIN 11866 series C	-	564920	564921	564922	564923	564924
	DIN 11850 series 2/DIN 11866 series A/DIN EN 10357 series A	-	564925	564926	564927	564928	564929
Stainless steel socket - Medium temperature max. 160 °C							
Welding socket	SMS 3008	-	564696	564696	564697	564697	**
	BS 4825-1/ASME BPE/DIN 11866 series C	-	564698	564698	564699	564699	564699
	DIN 11850 series 2/DIN 11866 series A/DIN EN 10357 series A	-	565069	565069	565069	565069	565390

** please refer to BS 4825-1/ASME BPE/DIN 11866 series C or to DIN 11850 series 2/DIN 11866 series A/DIN EN 10357 series A

 Further versions on request

Port connection

EN ISO 1127/ISO 4200/DIN 11866 series B (DN32...DN80)

Ordering chart for accessories/spare parts (other versions on request)

Fitting for flowmeter with G 2" connection

Description	Article no.
Stopper with ring, union nut and O-ring	
Stainless steel	438755
PVC	438754
PP	627614
Adapter with 4 screws (DN06...DN65)	
Stainless steel	555484
PVC	561175
PP	561176
PVDF	561177
O-Ring set (DN06...DN65)	
FKM - for metal fitting (5 units)	428971
EPDM - for metal fitting (5 units)	428972
FKM - for plastic fitting (1 flat gasket + 1 O-ring)	561043
EPDM - for plastic fitting (1 flat gasket + 1 O-ring)	561044
Measuring chamber	
Stainless steel ¹⁾ 316L - 1.4404	553611

¹⁾ other material on request

Fitting for flowmeter with clamp connection

Description	Article no.
1 EPDM fitting/flowmeter seal	730837
1 FEP fitting/flowmeter seal	730839
Clamp collar	731164
Stopper for fitting	565200

Approvals/Certificate (for both versions)

Description	Article no.
Inspection certificate 3.1 (acc. to EN-ISO 10204)	803723
Test report 2.2 (acc. to EN-ISO 10204)	803722
3 points Flow calibration certificate (S020 combined with the flow device inserted, only for DN ≤ 200)	550676
Certification of Conformity for the surface Quality (DIN4762-DIN4768-ISO/4287/1)	804175
FDA approval	803724

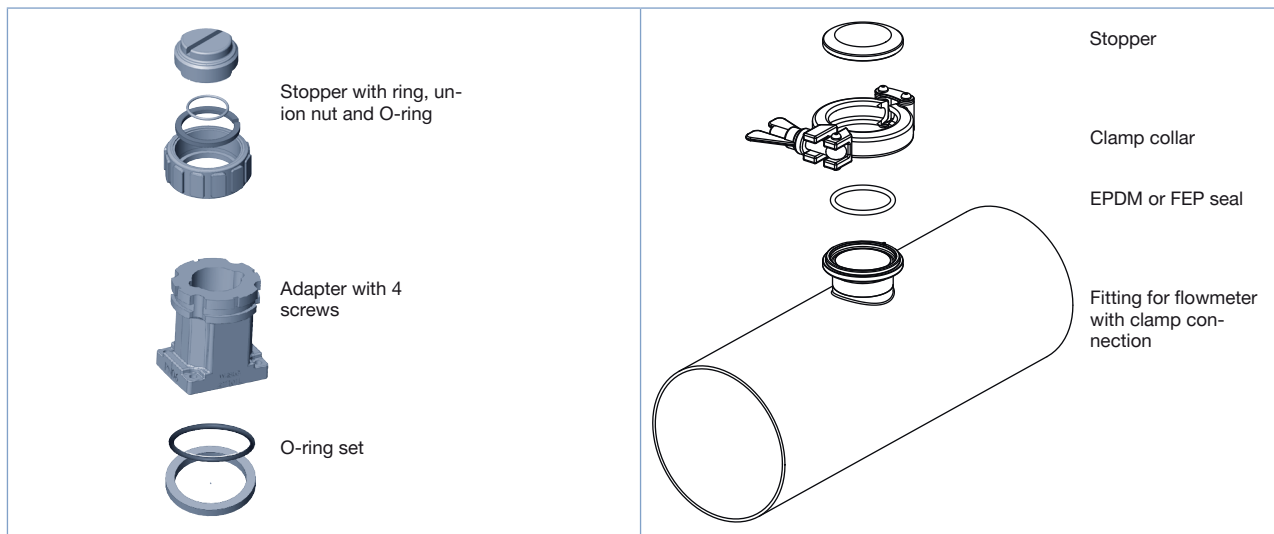

Interconnection possibilities with the S020

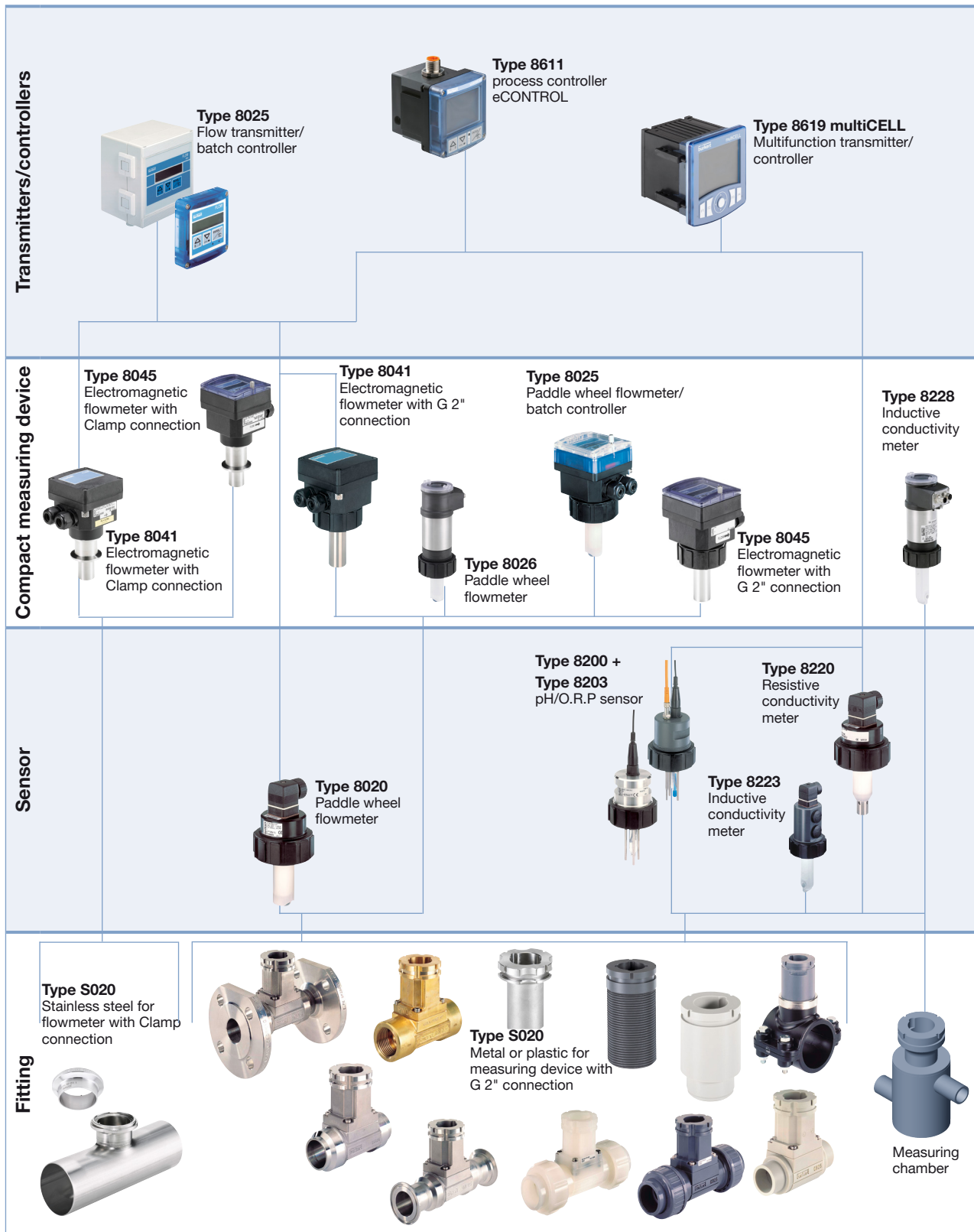

To find your nearest Bürkert facility, click on the orange box →

www.burkert.com

In case of special application conditions,
please consult for advice.

Subject to alteration.
© Christian Bürkert GmbH & Co. KG

1810/19_EU-en_00891872