

Clamp ferrules, clamps and gaskets - acc. DIN 32676

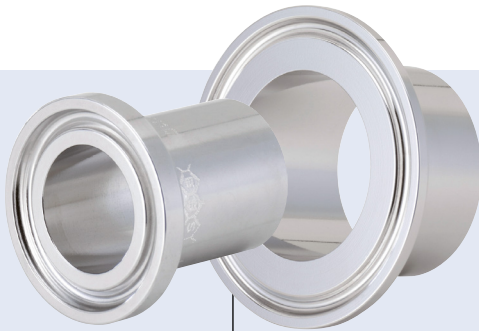

- According to standard norms and dimensions
- All medium contact materials traceable,
- Component of the BBS modular system

Type BBS-25 can be combined with...



Type 2103
Typ



Type 2034
Typ



Type 2100
Typ



Type 2300
Typ



Type 8098
Typ

The BBS-25 Clamp ferrules, gaskets and clamps are compatible with all standard market equipment.



For increased process security we recommend that you look at data sheets BBS-03 / BBS-05 / BBS-06.

Technical data







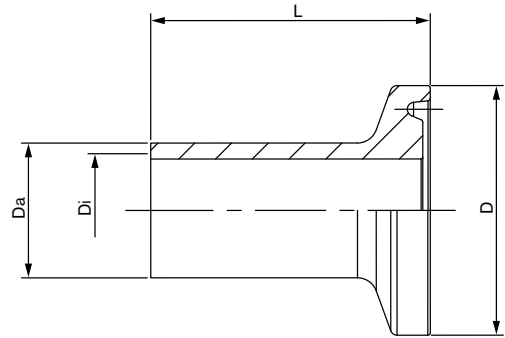

Available standard sizes	ISO DN08 to DN100 DIN DN08 to DIN100 BS-OD DN1/4" to DN4"
Material medium contact	Stainless steel 1.4435 BN2 (316L) Special materials on request
Material medium separated	1.4305 or equivalent
Seals	EPDM, FEP, special sealing materials on request
Surface quality	Medium contacted surface < Ra 0.8 µm, electro polished, finer surface on request
Ambient temperature	-20 to +80 °C
Media	Gases or liquids
Operating pressure	ISO DN08 to DN32 = 25 bar ISO DN40 to DN65 = 16 bar ISO DN80 to DN100 = 10 bar DIN DN08 to DN40 = 25 bar DIN DN50 to DN65 = 16 bar DIN DN80 to DN100 = 10 bar BS-OD DN1/4" to DN1½" = 25 bar BS-OD DN2" to DN3" = 16 bar BS-OD DN4" = 10 bar
Applicable standards	Acc. to DIN 32676 ISO dimensions series B DIN dimensions series A BS-OD dimensions series C (ASME BPE 2009)
Certifications	Material 3.1 FDA for all specified seal materials USP Class VI for EPDM, PTFE and FEP

BBS-25 Clamp ferrule

Dimensions [mm] Clamp ferrule

Orifice	D [mm]	Da [mm]	Di [mm]	L [mm]	Article no.
ISO Dimensions Clamp ferrule (up to clamp diameter DM 25)					
DN08	25.00	13.50	10.30	28.60	736995 
DN10	25.00	17.20	14.00	28.60	737026 



Orifice	D [mm]	Da [mm]	Di [mm]	L [mm]	Article no.
ISO Dimensions Clamp ferrule (from clamp diameter DM 50.5)					
DN15	50.50	21.30	18.10	36.00	747721 
DN20	50.50	26.90	23.70	36.00	747722 
DN25	50.50	33.70	29.70	36.00	747723 
DN32	64.00	42.40	38.40	36.00	747724 
DN40	64.00	48.30	44.30	36.00	747725 
DN50	77.50	60.30	56.30	36.00	747726 
DN65	91.00	76.10	72.10	48.00	747727 
DN80	106.00	88.90	84.30	48.00	736906 
DN100	130.00	114.30	109.70	48.00	747728 

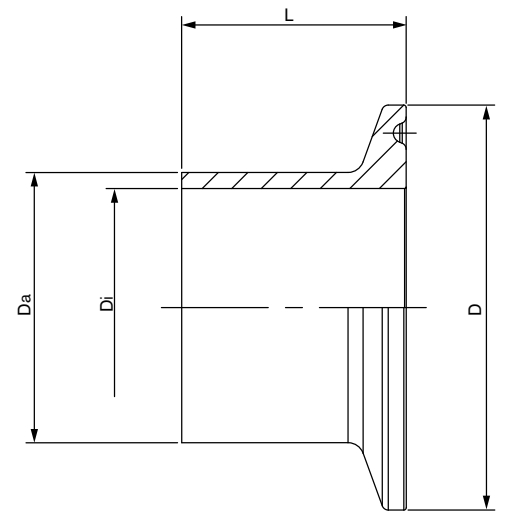

BBS-25 Clamp ferrule

Dimensions [mm] Clamp ferrule

Orifice	D [mm]	Da [mm]	Di [mm]	L [mm]	Article no.
DIN Dimensions Clamp ferrule (up to clamp diameter DM 25)					
DN08	25.00	10.00	8.00	28.60	736976
DN10	25.00	12.00	10.00	28.60	736983
DN10	25.00	13.00	10.00	28.60	743417
DN15	25.00	19.00	16.00	28.60	746017

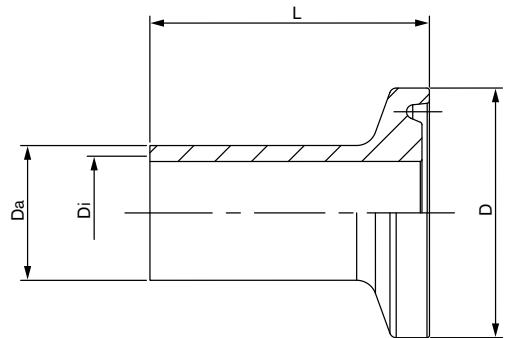

Orifice	D [mm]	Da [mm]	Di [mm]	L [mm]	Article no.
DIN Dimensions Clamp ferrule (from clamp diameter DM 34)					
DN10	34.00	12.00	10.00	35.00	746016
DN15	50.50	19.00	16.00	36.00	742808
DN20	34.00	23.00	20.00	28.60	742982
DN20	50.50	23.00	20.00	36.00	737543
DN25	50.50	29.00	26.00	36.00	747729
DN32	50.50	35.00	32.00	36.00	747730
DN40	50.50	41.00	38.00	36.00	747237
DN50	64.00	53.00	50.00	36.00	747731
DN65	91.00	70.00	66.00	48.00	747844
DN80	106.00	85.00	81.00	48.00	747845
DN100	119.00	104.00	100.00	48.00	747846

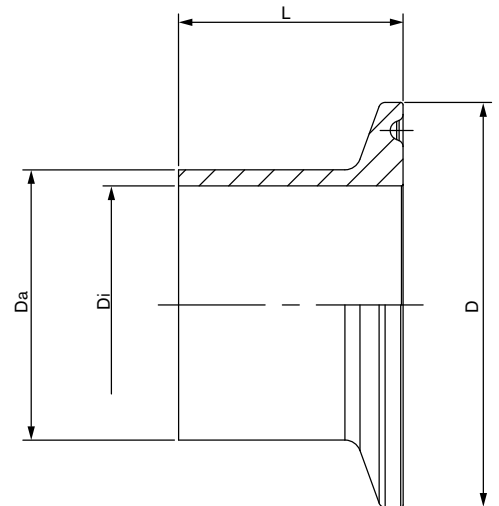

BBS-25 Clamp ferrule

Dimensions [mm] Clamp ferrule

Orifice	D [mm]	Da [mm]	Di [mm]	L [mm]	Article no.
BS-OD Dimensions Clamp ferrule (up to clamp diameter DM 25)					
DN1/4"	25.00	6.35	4.57	28.60	737234
DN3/8"	25.00	9.53	7.75	28.60	737238
DN1/2"	25.00	12.70	9.40	28.60	737258
DN3/4"	25.00	19.05	15.75	28.60	737292

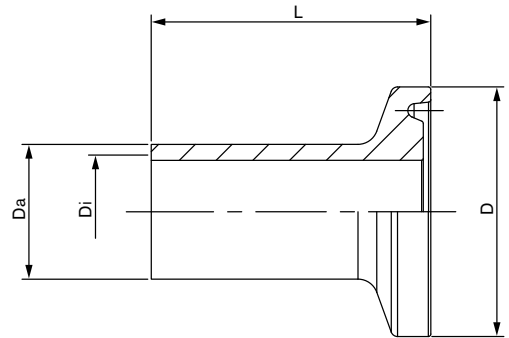

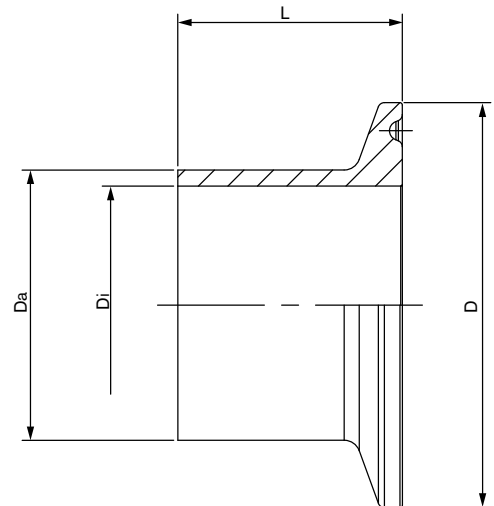

Orifice	D [mm]	Da [mm]	Di [mm]	L [mm]	Article no.
BS-OD Dimensions Clamp ferrule (from clamp diameter DM 50.5)					
DN1"	50.50	25.40	22.10	36.00	737315
DN1½"	50.50	38.10	34.80	36.00	742943
DN2"	64.00	50.80	47.50	36.00	737379
DN2½"	77.50	63.50	60.20	36.00	737404
DN3"	91.00	76.20	72.90	48.00	747678
DN4"	119.00	101.60	97.40	48.00	737429









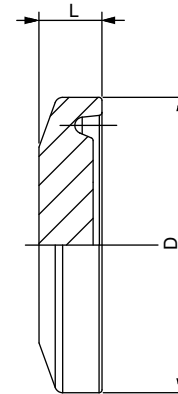

BBS-25 Clamp ferrule

Dimensions [mm] Clamp ferrule blind cover

Orifice	D [mm]	L [mm]	Article no.
ISO Dimensions Clamp ferrule blind cover (up to clamp diameter DM 25)			
DN08	25.00	4.75	738019 
DN10	25.00	4.75	738019 



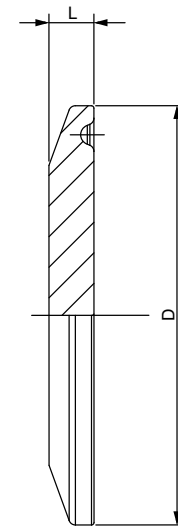

Orifice	D [mm]	L [mm]	Article no.
ISO Dimensions Clamp ferrule (from clamp diameter DM 50.5)			
DN15	50.50	6.35	738052 
DN20	50.50	6.35	738052 
DN25	50.50	6.35	738052 
DN32	64.00	6.35	738064 
DN40	64.00	6.35	738064 
DN50	77.50	6.35	738068 
DN65	91.00	6.35	738072 
DN80	106.00	6.35	738076 
DN100	130.00	8.00	738027 









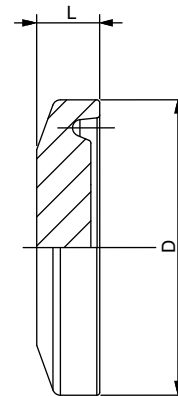





BBS-25 Clamp ferrule

Dimensions [mm] Clamp ferrule blind cover

Orifice	D [mm]	L [mm]	Article no.
DIN Dimensions Clamp ferrule blind cover (up to clamp diameter DM 25)			
DN08	25.00	4.75	738019 
DN10	25.00	4.75	738019 
DN15	25.00	4.75	738019 





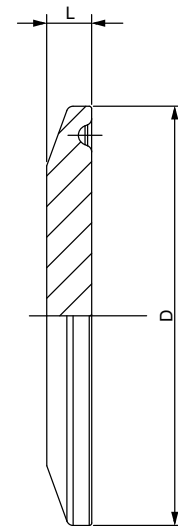

Orifice	D [mm]	L [mm]	Article no.
DIN Dimensions Clamp ferrule (from clamp diameter DM 34)			
DN10	34.00	6.35	738023 
DN15	34.00	6.35	738023 
DN15	50.50	6.35	738052 
DN20	34.00	6.35	738023 
DN20	50.50	6.35	738052 
DN25	50.50	6.35	738052 
DN32	50.50	6.35	738052 
DN40	50.50	6.35	738052 
DN50	64.00	6.35	738064 
DN65	91.00	6.35	738072 
DN80	106.00	6.35	738076 
DN100	119.00	8.00	738104 







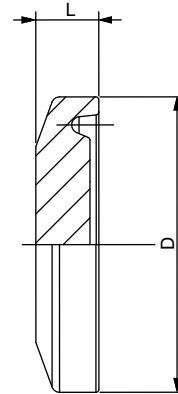

BBS-25 Clamp ferrule

Dimensions [mm] Clamp ferrule blind cover

Orifice	D [mm]	L [mm]	Article no.
BS-OD Dimensions Clamp ferrule blind cover (up to clamp diameter DM 25)			
DN1/4"	25.00	4.75	738019 
DN3/8"	25.00	4.75	738019 
DN1/2"	25.00	4.75	738019 
DN3/4"	25.00	4.75	738019 



Orifice	D [mm]	L [mm]	Article no.
BS-OD Dimensions Clamp ferrule (from clamp diameter DM 50.5)			
DN1"	50.50	6.35	738052 
DN1½"	50.50	6.35	738052 
DN2"	64.00	6.35	738064 
DN2½"	77.50	6.35	738068 
DN3"	91.00	6.35	738072 
DN4"	119.00	8.00	738104 

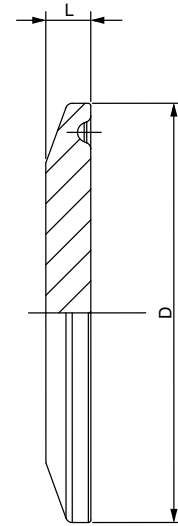

Dimensions [mm] Clamp gaskets

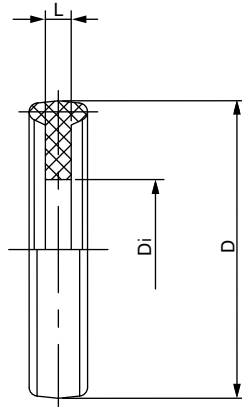

(up to clamp diameter DM 25)

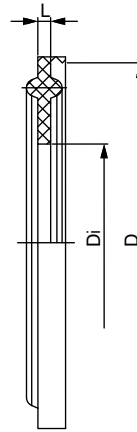

(from clamp diameter DM 34)

Orifice	D [mm]	Di [mm]	L (±0.2)	Article no. EPDM	Article no. PTFE
ISO Dimensions Clamp gaskets (up to clamp diameter DM 25)					
DN08	22.00	10.30	2.00	730049	730050
DN10	22.00	14.00	2.00	730069	730071
ISO Dimensions Clamp gaskets (from clamp diameter DM 34)					
DN08	34.00	10.30	2.00	747707	747709
DN08	50.50	10.30	2.00	730065	730067
DN10	34.00	14.00	2.00	730081	747708
DN10	50.50	14.00	2.00	730086	730088
DN15	34.00	18.10	2.00	730107	747710
DN15	50.50	18.10	2.00	730112	730114
DN20	50.50	23.70	2.00	730134	730136
DN25	50.50	29.70	2.00	730155	730157
DN32	64.00	38.40	2.00	730169	730171
DN40	64.00	44.30	2.00	730181	730183
DN50	77.50	56.30	2.00	730194	730196
DN65	91.00	72.10	2.00	730206	730208
DN80	106.00	84.30	2.00	730218	730220
DN100	130.00	84.30	2.00	730094	730096
DIN Dimensions Clamp gaskets (up to clamp diameter DM 25)					
DN08	22.00	8.00	2.00	730035	730036
DN10	22.00	10.00	2.00	730041	730042
DN15	22.00	10.00	2.00	744319	745964
DIN Dimensions Clamp gaskets (from clamp diameter DM 34)					
DN10	34.00	10.00	2.00	744295	744307
DN15	34.00	16.00	2.00	743978	743970
DN20	34.00	20.00	2.00	743964	747711
DN20	50.50	20.00	2.00	730472	730474
DN25	50.50	26.00	2.00	730505	730507
DN32	50.50	32.00	2.00	730556	730558
DN32	64.00	32.00	2.00	730564	730566
DN40	50.50	38.00	2.00	730581	730583
DN50	64.00	50.00	2.00	730614	730616
DN65	91.00	66.00	2.00	730663	730665
DN80	106.00	81.00	2.00	730686	730688
DN100	119.00	100.00	2.00	730397	730400

BBS-25

Clamp ferrule

Dimensions [mm] Clamp gaskets

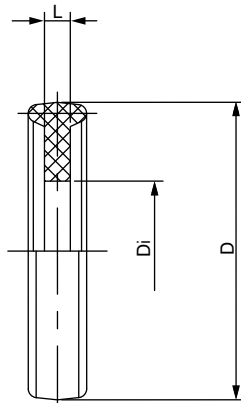

(up to clamp diameter DM 25)

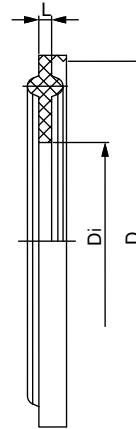

(from clamp diameter DM 34)

Orifice	D [mm]	Di [mm]	L (±0.2)	Article no. PTFE / core FKM	Article no. Silicone
ISO Dimensions Clamp gaskets (up to clamp diameter DM 25)					
DN08	22.00	10.30	2.00	730053	730059
DN10	22.00	14.00	2.00	730073	730077
ISO Dimensions Clamp gaskets (from clamp diameter DM 34)					
DN08	34.00	10.30	2.00	730063	747712
DN08	50.50	10.30	2.00	743487	747713
DN10	34.00	14.00	2.00	743488	730084
DN10	50.50	14.00	2.00	730073	730092
DN15	34.00	18.10	2.00	730109	747714
DN15	50.50	18.10	2.00	730116	730122
DN20	50.50	23.70	2.00	730138	730142
DN25	50.50	29.70	2.00	730159	730163
DN32	64.00	38.40	2.00	730173	730177
DN40	64.00	44.30	2.00	730185	730190
DN50	77.50	56.30	2.00	730198	730202
DN65	91.00	72.10	2.00	730210	730214
DN80	106.00	84.30	2.00	730222	730227
DN100	130.00	84.30	2.00	730098	730101
DIN Dimensions Clamp gaskets (up to clamp diameter DM 25)					
DN08	22.00	8.00	2.00	747715	730037
DN10	22.00	10.00	2.00	747716	730043
DN15	22.00	10.00	2.00	747717	747718
DIN Dimensions Clamp gaskets (from clamp diameter DM 34)					
DN10	34.00	10.00	2.00	747732	745966
DN15	34.00	16.00	2.00	730046	745960
DN20	34.00	20.00	2.00	742985	747735
DN25	50.50	26.00	2.00	730509	730511
DN32	50.50	32.00	2.00	747737	730560
DN32	64.00	32.00	2.00	747738	747740
DN40	50.50	38.00	2.00	730585	730587
DN50	64.00	50.00	2.00	730618	730620
DN65	91.00	66.00	2.00	747741	730667
DN80	106.00	81.00	2.00	747742	747743
DN100	119.00	100.00	2.00	747744	730404

BBS-25 Clamp ferrule

Dimensions [mm] Clamp gaskets

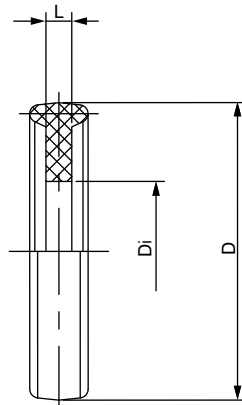

(up to clamp diameter DM 25)

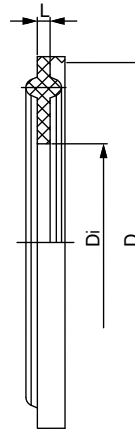

(from clamp diameter DM 34)

Orifice	D [mm]	Di [mm]	L (±0.2)	Article no. FKM
ISO Dimensions Clamp gaskets (up to clamp diameter DM 25)				
DN08	22.00	10.30	2.00	730061
DN10	22.00	14.00	2.00	730079
ISO Dimensions Clamp gaskets (from clamp diameter DM 34)				
DN08	34.00	10.30	2.00	747745
DN08	50.50	10.30	2.00	747746
DN10	34.00	14.00	2.00	747747
DN10	50.50	14.00	2.00	747748
DN15	34.00	18.10	2.00	747749
DN15	50.50	18.10	2.00	730124
DN20	50.50	23.70	2.00	730144
DN25	50.50	29.70	2.00	730165
DN32	64.00	38.40	2.00	730179
DN40	64.00	44.30	2.00	730192
DN50	77.50	56.30	2.00	730204
DN65	91.00	72.10	2.00	730216
DN80	106.00	84.30	2.00	730229
DN100	130.00	84.30	2.00	747751
DIN Dimensions Clamp gaskets (up to clamp diameter DM 25)				
DN08	22.00	8.00	2.00	730038
DN10	22.00	10.00	2.00	730044
DN15	22.00	10.00	2.00	747750
DIN Dimensions Clamp gaskets (from clamp diameter DM 34)				
DN10	34.00	10.00	2.00	747752
DN15	34.00	16.00	2.00	747753
DN20	34.00	20.00	2.00	747754
DN20	50.50	20.00	2.00	730478
DN25	50.50	26.00	2.00	730513
DN32	50.50	32.00	2.00	730562
DN32	64.00	32.00	2.00	747755
DN40	50.50	38.00	2.00	730589
DN50	64.00	50.00	2.00	730622
DN65	91.00	66.00	2.00	730669
DN80	106.00	81.00	2.00	730690
DN100	119.00	100.00	2.00	747756

Dimensions [mm] Clamp gaskets

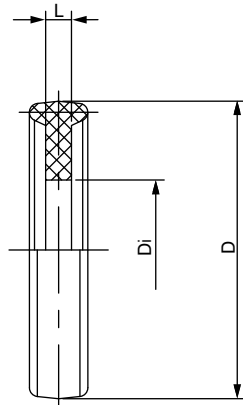

(up to clamp diameter DM 25)

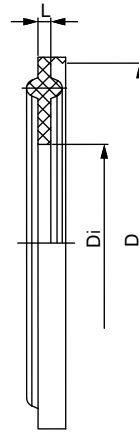

(from clamp diameter DM 34)

Orifice	D [mm]	Di [mm]	L (±0.2)	Article no. EPDM	Article no. PTFE
BS-OD Dimensions Clamp gaskets (up to clamp diameter DM 25)					
DN1/4"	22.00	4.57	2.00	730231	730233
DN3/8"	22.00	7.75	2.00	730239	730242
DN1/2"	22.00	9.40	2.00	730246	730248
DN3/4"	22.00	15.75	2.00	730256	730258
BS-OD Dimensions Clamp gaskets (from clamp diameter DM 50.5)					
DN1"	50.50	22.10	2.00	730264	730266
DN1½"	50.50	34.80	2.00	730277	730279
DN2"	64.00	47.50	2.00	730289	730291
DN2½"	77.50	60.20	2.00	730301	730303
DN3"	91.00	72.90	2.00	730311	730313
DN4"	119.00	97.40	2.00	730322	730324

BBS-25 Clamp ferrule

Dimensions [mm] Clamp gaskets

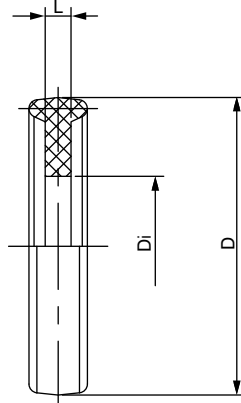

(up to clamp diameter DM 25)

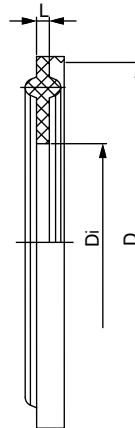

(from clamp diameter DM 34)

Orifice	D [mm]	Di [mm]	L (±0.2)	Article no. PTFE/ core FKM	Article no. Silicone
BS-OD Dimensions Clamp gaskets (up to clamp diameter DM 25)					
DN1/4"	22.00	4.57	2.00	747757	730235
DN3/8"	22.00	7.75	2.00	747758	730244
DN1/2"	22.00	9.40	2.00	744320	730252
DN3/4"	22.00	15.75	2.00	747760	730260
BS-OD Dimensions Clamp gaskets (from clamp diameter DM 50.5)					
DN1"	50.50	22.10	2.00	730268	730273
DN1½"	50.50	34.80	2.00	730281	730283
DN2"	64.00	47.50	2.00	730293	730297
DN2½"	77.50	60.20	2.00	730305	730307
DN3"	91.00	72.90	2.00	730315	730317
DN4"	119.00	97.40	2.00	730326	730328

BBS-25 Clamp ferrule

Dimensions [mm] Clamp gaskets

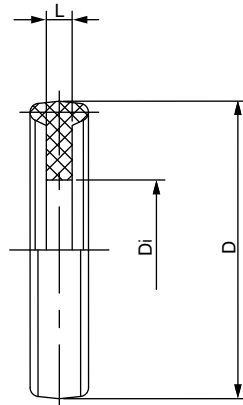

(up to clamp diameter DM 25)

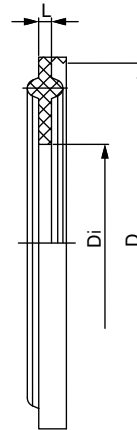

(from clamp diameter DM 34)

Orifice	D [mm]	Di [mm]	L (±0.2)	Article no. FKM
BS-OD Dimensions Clamp gaskets (up to clamp diameter DM 25)				
DN1/4"	22.00	4.57	2.00	730237
DN3/8"	22.00	7.75	2.00	747762
DN1/2"	22.00	9.40	2.00	730254
DN3/4"	22.00	15.75	2.00	730262
BS-OD Dimensions Clamp gaskets (from clamp diameter DM 50.5)				
DN1"	50.50	22.10	2.00	730275
DN1½"	50.50	34.80	2.00	730285
DN2"	64.00	47.50	2.00	730299
DN2½"	77.50	60.20	2.00	730309
DN3"	91.00	72.90	2.00	730319
DN4"	119.00	97.40	2.00	730330

BBS-25 Clamp ferrule

Dimensions [mm] Clamp

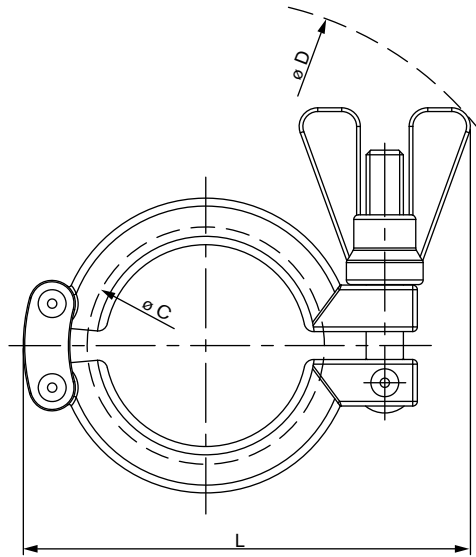

Orifice	C [mm]	D [mm]	L [mm]	Max. operating pressure [bar] to 150 °C	Article no.
ISO Dimensions Clamp					
DN08	25.00	130.00	64.00	50.00	731146 𐀀
DN10	25.00	130.00	64.00	50.00	731146 𐀀
DN15	50.50	154.00	93.00	50.00	731164 𐀀
DN20	50.50	154.00	93.00	50.00	731164 𐀀
DN25	50.50	154.00	93.00	50.00	731164 𐀀
DN32	64.00	180.00	108.00	50.00	731172 𐀀
DN40	64.00	180.00	108.00	50.00	731172 𐀀
DN50	77.50	200.00	125.00	50.00	731174 𐀀
DN65	91.00	105.00	139.00	40.00	731176 𐀀
DN80	106.00	116.00	144.00	40.00	731178 𐀀
DN100	130.00	240.00	173.00	30.00	731154 𐀀

Orifice	C [mm]	D [mm]	L [mm]	Max. operating pressure [bar] to 150 °C	Article no.
DIN Dimensions Clamp					
DN08	25.00	130.00	64.00	50.00	731146 𐀀
DN10	25.00	130.00	64.00	50.00	731146 𐀀
DN10	34.00	130.00	68.00	50.00	731150 𐀀
DN15	25.00	130.00	64.00	50.00	731146 𐀀
DN15	34.00	130.00	68.00	50.00	731150 𐀀
DN20	34.00	130.00	68.00	50.00	731150 𐀀
DN20	50.50	154.00	93.00	50.00	731164 𐀀
DN25	50.50	154.00	93.00	50.00	731164 𐀀
DN32	50.50	154.00	93.00	50.00	731164 𐀀
DN40	50.50	154.00	93.00	50.00	731164 𐀀
DN50	64.00	180.00	108.00	50.00	731172 𐀀
DN65	91.00	105.00	139.00	40.00	731176 𐀀
DN80	106.00	116.00	144.00	40.00	731178 𐀀
DN100	119.00	240.00	171.00	35.00	731144 𐀀
DN80	106.00	116.00	144.00	40.00	731178 𐀀
DN100	119.00	240.00	171.00	35.00	731144 𐀀

Dimensions [mm] Clamp

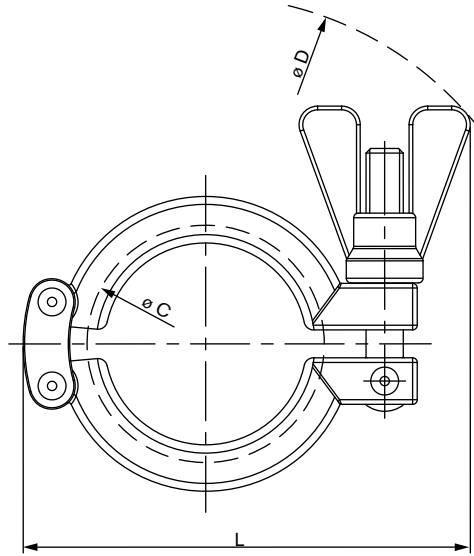

Orifice	C [mm]	D [mm]	L [mm]	Max. operating pressure [bar] to 150 °C	Article no.
BS-OD Dimensions Clamp					
DN1/4"	25.00	130.00	64.00	50.00	731146
DN3/8"	25.00	130.00	64.00	50.00	731146
DN1/2"	25.00	130.00	64.00	50.00	731146
DN3/4"	25.00	130.00	64.00	50.00	731146
DN1"	50.50	154.00	93.00	50.00	731164
DN1½"	50.50	154.00	93.00	50.00	731164
DN2"	64.00	180.00	108.00	50.00	731172
DN2½"	77.50	200.00	125.00	50.00	731174
DN3"	91.00	105.00	139.00	40.00	731176
DN4"	119.00	240.00	171.00	35.00	731144

DTS 1000175512 EN Version: G Status: RL (released | freigegeben | valide) printed: 06.07.2018

To find your nearest Bürkert facility, click on the orange box →

www.burkert.com

In case of special application conditions, please consult for advice.

Subject to alteration.
© Christian Bürkert GmbH & Co. KG

1807/6_EUen_00895202