

## Mass Flow Meter for Gases (MFM)



- Nominal flow ranges from 0.010 I<sub>N</sub>/min to 80 I<sub>N</sub>/min
- High accuracy
- Very fast response times
- Optional: Fieldbus interface

Type 8701 can be combined with...



**Type 8619**

Multichannel program controller



**Type 0330**

3/2 or 2/2 way solenoid valve



**Typ 6027**

2/2 way plunger valve



**Typ 8611**

eCONTROL

The mass flow meter (MFM) type 8701 is suited for measuring the mass flow of gases over a big flow range. The thermal MEMS sensor is located directly in the gas stream and therefore reaches very fast response times.

Type 8701 can optionally be calibrated for two different gases; the user can switch between these two gases. As electrical interfaces both, analog standard signals and fieldbuses are available.

Technical Data	
<b>Nominal flow range<sup>1)</sup> (Q<sub>nom</sub>)</b>	10 ml <sub>N</sub> /min <sup>2)</sup> to 80 I <sub>N</sub> /min (N <sub>2</sub> ), see table on p. 2
<b>Span</b>	1:50 (2... 100%), higher span on request
<b>Operating gas</b>	Neutral, non-contaminated gases, others on request
<b>Calibration gas</b>	Operating gas or air with conversion factor
<b>Max. operating pressure (inlet pressure)</b>	10 bar (145 psi)
<b>Gas temperature</b>	-10 ... +70 °C (-10 ... +60 °C with oxygen)
<b>Ambient temperature</b>	-10 ... +50 °C
<b>Accuracy (after 1 min. warm up time)</b>	± 0.8% o.R. (of reading) ± 0.3% F.S. (of full scale)
<b>Repeatability</b>	± 0.1% F.S.
<b>Response time (t<sub>95%</sub>)</b>	< 300 ms
<b>Materials</b>	Body: Aluminium or stainless steel Housing: PC (Polycarbonate) or metal FKM, EPDM Seals: FKM, EPDM
<b>Port connection</b>	NPT 1/4, G 1/4, screw-in fitting or flange, others on request
<b>Electr. connection</b>	Plug D-Sub 15 pin with PROFIBUS DP; Socket M12 5 pin with CANopen; Socket M12 5 pin
<b>Power supply</b>	24 V DC
<b>Voltage tolerance</b>	± 10%
<b>Residual ripple</b>	< 2%
<b>Power consumption</b>	2.5 W / 5 W (with fieldbus)
<b>Output signal (process value)</b>	0 ... 5 V, 0 ... 10 V, 0 ... 20 mA or 4 ... 20 mA
Max. current (voltage)	10 mA
Max. load (current)	600 Ω
<b>Digital communication</b>	RS232, Modbus RTU (via RS adapter) RS485, RS422 or USB (see accessories table on p. 3)
via adapter possible:	
<b>Fieldbus option</b>	PROFIBUS DP, CANopen
<b>Protection class</b>	IP40
<b>Dimensions [mm]</b>	see drawings on pages 5...6
<b>Total weight</b>	ca. 500 g (aluminium body)
<b>Installation</b>	horizontal or vertical
<b>Light emitting diodes</b>	Indication for power, Limit (with analog signals) / Communication (with fieldbus) and error
(default functions, other functions programmable)	
<b>Binary inputs</b>	Two
(default functions, other functions programmable)	1. not assigned 2. not assigned
<b>Binary output</b>	A relay output for:
(default functions, other functions programmable)	1. Limit (actual value close to Q <sub>nom</sub> ) Max. Load: 25 V, 1 A, 25 VA

<sup>1)</sup> The nominal flow value is the max. flow value calibrated which can be measured. The nominal flow range defines the range of nominal flow rates (full scale values) possible.

<sup>2)</sup> Index N: Flow rates referred to 1.013 bar and 0 °C.

Alternatively there is an Index S available which refers to 1.013 bar and 20 °C

## Measuring Principle

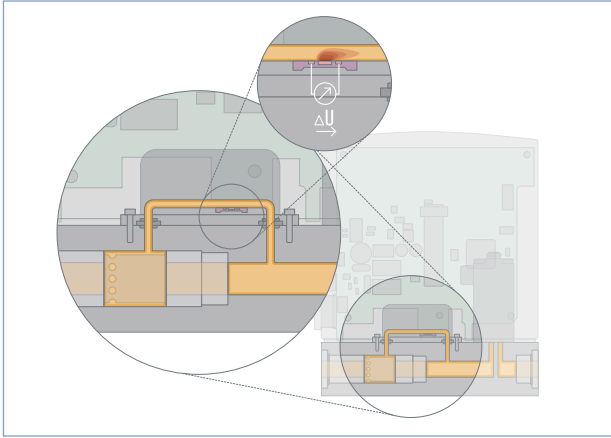

The mass flow sensor operates according to a thermal principle which has the advantage of providing the mass flow which is independent on pressure and temperature.

A small part of the total gas stream is diverted into a small, specifically designed bypassing channel which ensures laminar flow conditions. The sensor element is a chip immersed into the wall of this flow channel. The chip, produced in MEMS technology, contains a heating resistor and two temperature sensors (thermopiles) which are arranged symmetrically upstream and downstream of the heater. The differential voltage of the thermopiles is a measure of the mass flow rate passing the flow sensor. The calibration procedure effectuates a unique assignment of the sensor signal to the total flow rate through the device.

## Pressure Loss Diagram (ref. to air, with 250µm inlet filter)

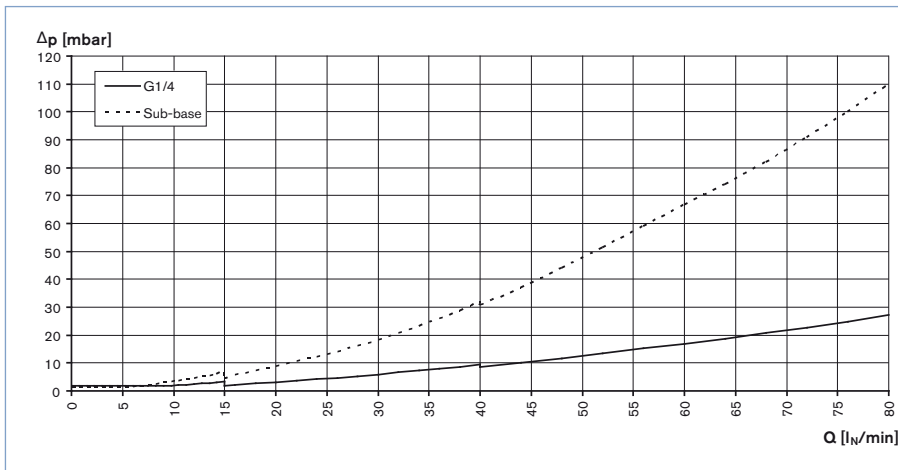

The diagram shows exemplarily the pressure loss characteristics when air flowing through.

For determining the pressure loss with another gas it needs to calculate the air equivalent and respect the fluidics needed with the other gas.

## Nominal Flow Range of Typical Gases

(Other gases on request)

















Gas	Min. $Q_{nom}$ [lN/min]	Max. $Q_{nom}$ [lN/min]
Argon	0.01	80
Helium	0.01	500
Carbon dioxide	0.02	40
Air	0.01	80
Methane	0.01	80
Oxygen	0.01	80
Nitrogen	0.01	80
Hydrogen	0.01	500

## Notes regarding the selection of the unit

The decisive factors for the perfect functioning of an MFM within the application are the fluid compatibility, the normal inlet pressure and the correct choice of the flow meter range. The pressure drop over the MFM depends on the flow rate and the operating pressure.

► The request for quotation form on page 7 contains the relevant fluid specification.

Ordering Chart for Accessories

Article	Article no.	
<b>Connections/Cables</b>		
Socket D-Sub 15 pin solder connection	918274 	
Hood for D-Sub socket, with screw locking	918408 	
Socket D-Sub 15 pin with 5 m cable	787737 	
Socket D-Sub 15 pin with 10 m cable	787738 	
<b>Adapters<sup>3)</sup></b>		
RS232 adapter (for connection of a PC, in combination with the PC cable)	654748 	
PC extension cable for RS232 9 pin socket/plug 2 m	917039 	
RS422 adapter (RS485 compatible)	666371 	
USB adapter (Version 1.1, USB socket type B)	670639 	
USB connection cable 2 m	772299 	
Communication software MassFlowCommunicator	Download from <a href="http://www.buerkert.com">www.buerkert.com</a>	
<b>Accessories for Fieldbus</b>	<b>PROFIBUS DP (B-coded)</b>	<b>CANopen (A-coded)</b>
Plug M12 <sup>4)</sup>	918198 	917115 
Socket M12 <sup>4)</sup>	918447 	917116 
Y-junction <sup>4)</sup>	902098 	788643 
Terminating resistor	902553 	(on request)
GSD-File (PROFIBUS), EDS-File (CANopen)	Download from <a href="http://www.buerkert.com">www.buerkert.com</a>	

<sup>3)</sup> The adapters serve mainly for initial operation or diagnosis. Those are not obligatory for continuous operation.

<sup>4)</sup> The two M12 connectors as listed above cannot be used together on the same side of the Y-junction.

At least one of the two M12 connection needs to be an overmoulded cable which uses typically a thinner connector. A T-junction cannot be used together with this type of MFM.

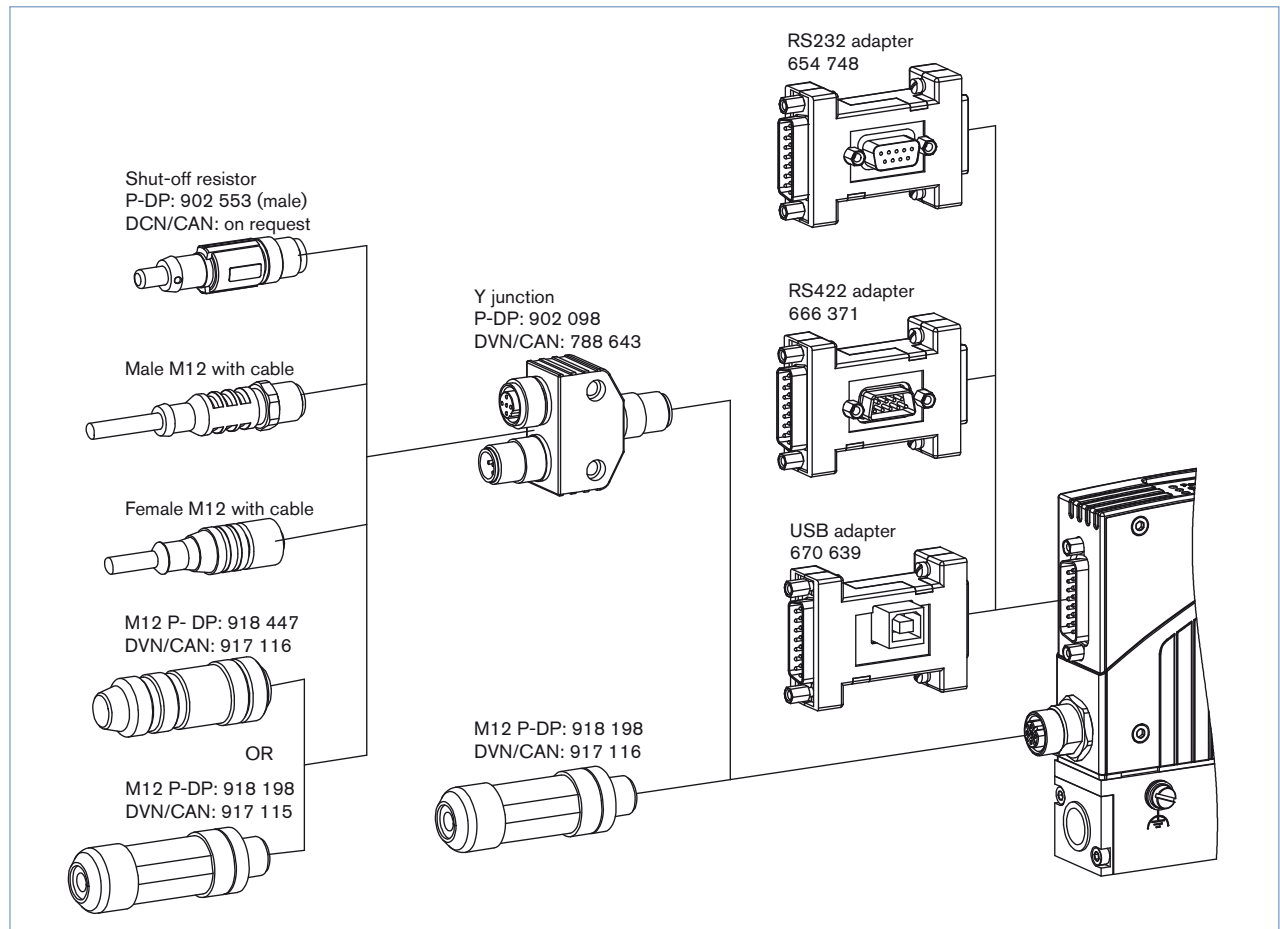

Pin Assignment

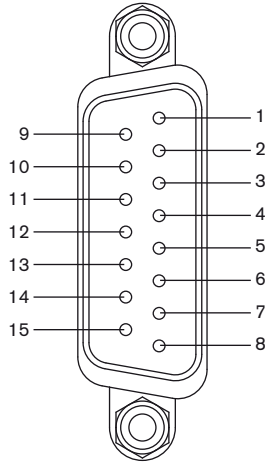
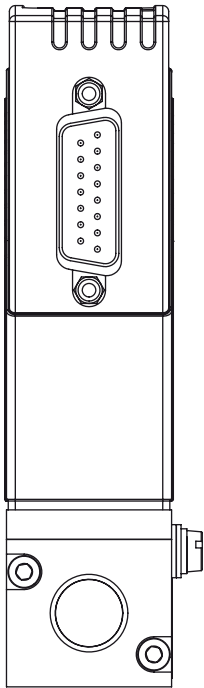

Plug D-Sub, 15 pin

Pin	Assignment	
	Analogue Control	Bus control
1	Relay – normally closed contact	
2	Relay – normally open contact	
3	Relay – reference	
4	GND for 24 V Supply and binary inputs	
5	24 V supply +	
6	12 V output (only for factory use)	
7	N.C.	N.C. <sup>5)</sup>
8	N.C.	N.C.
9	Actual value output GND	N.C.
10	Actual value output +	N.C.
11	DGND (for RS232) <sup>6)</sup>	
12	Binary input 1	
13	Binary input 2	
14	RS232 RxD (without driver) <sup>6)</sup>	
15	RS232 TxD (without driver) <sup>6)</sup>	

<sup>5)</sup> N.C.: not connected (not used)

Note:

– Optional Pin 7 and 8 with bus version as transmitter input possible  
 – The cable length for RS232/ Setpoint and actual value signal is limited to 30 meters.

<sup>6)</sup> Driving RS232 interface only by RS232 adapter including an adaption of TTL levels

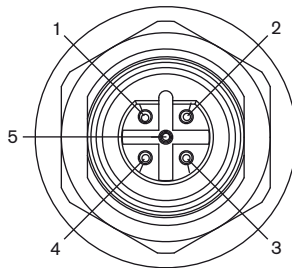
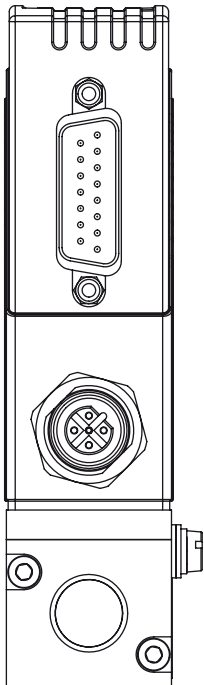

With Fieldbus Version:

PROFIBUS DP – Socket B-coded M12 (DPV1 max. 12 Mbaud)

Pin	Assignment
1	VDD (only for termination resistor)
2	RxD/ TxD – N (A-Line)
3	DGND
4	RxD/ TxD – P (B-Line)
5	N.C.

CANopen – Plug M12

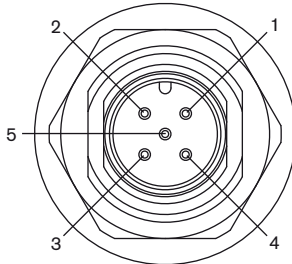

Pin	Assignment
1	Shield
2	N.C.
3	DGND
4	CAN_H
5	CAN_L

Dimensions [mm]

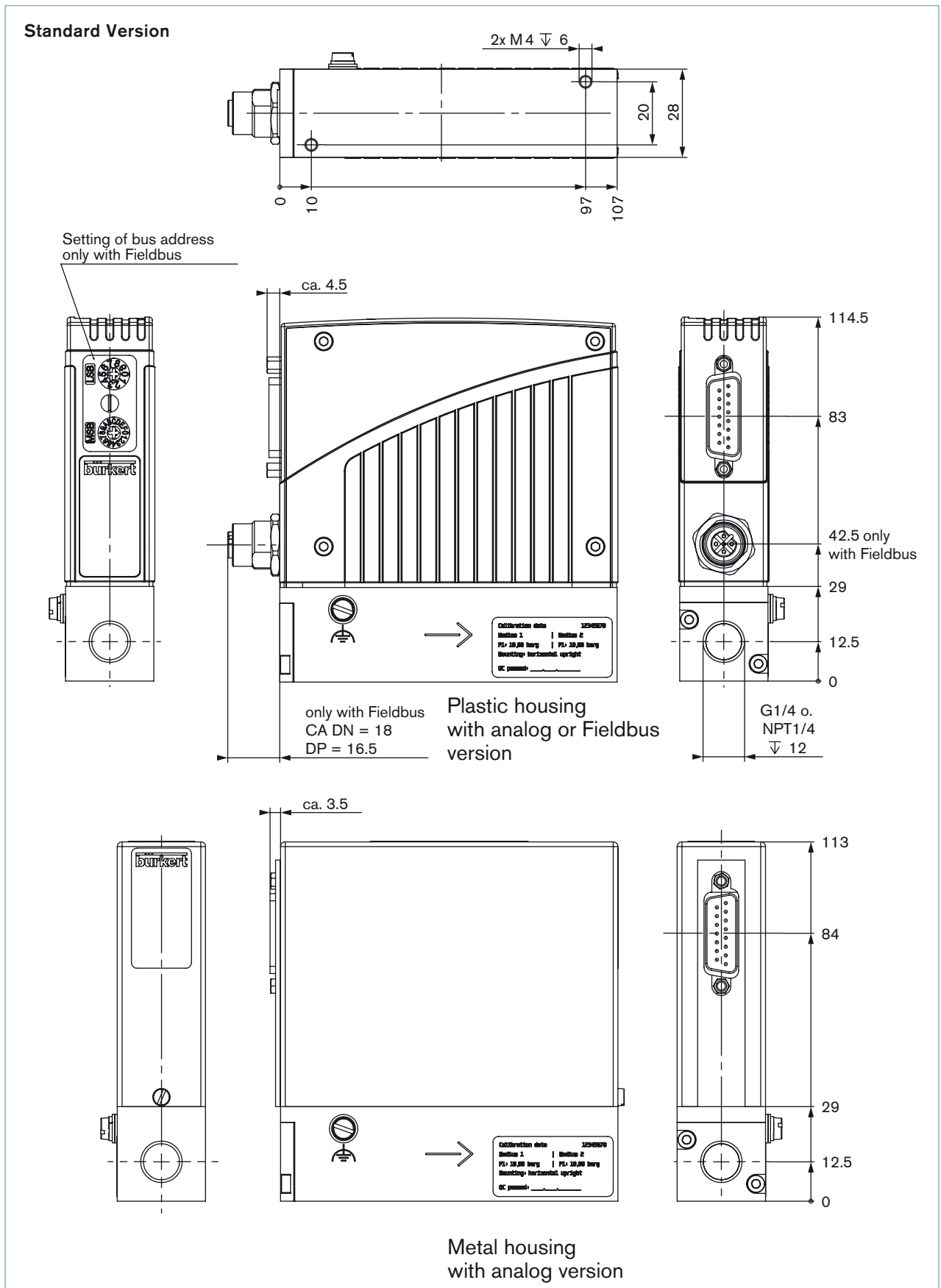

DTS 1000019862 EN Version: Q Status: RL (released | freigegeben | valide) printed: 05.03.2018

Dimensions [mm]

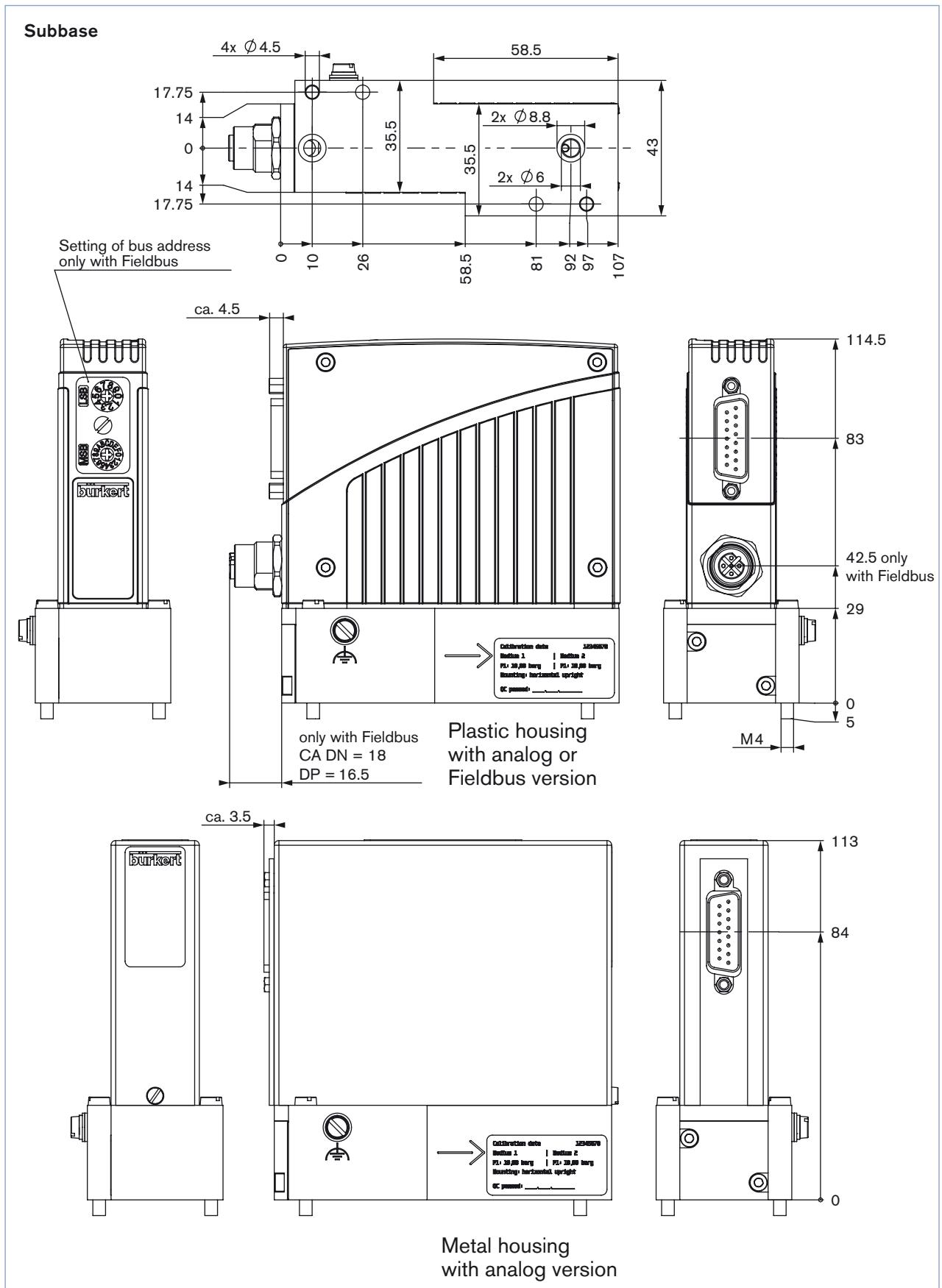

DTS 1000019862 EN Version: Q Status: RL (released | freigegeben | valide) printed: 05.03.2018

## MFC/MFM-applications – Request for quotation

▶ Please complete and send to your nearest Bürkert sales centre

Company	Contact person
Customer No	Department
Address	Tel./Fax
Postcode/Town	E-mail

 MFC-Application     MFM-Application     Quantity     Required delivery date

## Medium data

Type of gas (or gas proportion in mixtures)

Density  kg/m<sup>3(7)</sup>

Gas temperature [°C or °F]  °C     °F

Moisture content  g/m<sup>3</sup>

Abrasive components/solid particles  no     yes, as follows:

## Fluidic data

Flow range  $Q_{nom}$   Min.  l<sub>N</sub>/min<sup>(7)</sup>     l<sub>S</sub>/min (slpm)<sup>(8)</sup>  
 Max.  m<sub>N</sub><sup>3</sup>/h<sup>(7)</sup>     kg/h  
 cm<sub>N</sub><sup>3</sup>/min<sup>(7)</sup>     cm<sub>S</sub><sup>3</sup>/min (scm)<sup>(8)</sup>  
 l<sub>N</sub>/h<sup>(7)</sup>     l<sub>S</sub>/h<sup>(8)</sup>

Inlet pressure at  $Q_{nom}$ <sup>(9)</sup>     $p_1 =$   bar(g) ■

Outlet pressure at  $Q_{nom}$      $p_2 =$   bar(g) ■

Max. inlet pressure  $p_{1,max}$   bar(g) ■

MFC/MFM port connection

without screw-in fitting

¼" G-thread (DIN ISO 228/1)

¼" NPT-thread (ANSI B1.2)

with screw-in fitting

mm pipe (external Ø)

inch pipe (external Ø)

Flange version

Installation

horizontal

vertical, flow upwards     vertical, flow downwards

Ambient temperature  °C

## Material data

Body  Stainless steel     Aluminium

Housing  Plastic     Metal (not with type 8712/8702 and not with fieldbus)

Seal  FKM     EPDM

## Electrical data

Signals for set point and actual value	with standard signal		with fieldbus
	Setpoint	actual value	
<input type="checkbox"/> 0 ... 5 V	<input type="checkbox"/> 0 ... 5 V	<input type="checkbox"/> PROFIBUS DP <input type="checkbox"/> CANopen	
<input type="checkbox"/> 0 ... 10 V	<input type="checkbox"/> 0 ... 10 V		
<input type="checkbox"/> 0 ... 20 mA	<input type="checkbox"/> 0 ... 20 mA		
<input type="checkbox"/> 4 ... 20 mA	<input type="checkbox"/> 4 ... 20 mA		

■ Please quote all pressure values as overpressures with respect to atmospheric pressure bar(ü)

7) at: 1.013 bar(a) and 0 °C

8) at: 1.013 bar (a) and 20 °C

9) matches with calibration pressure

To find your nearest Bürkert facility, click on the orange box →

[www.buerkert.com](http://www.buerkert.com)

In case of special application conditions, please consult for advice.

Subject to alteration.  
© Christian Bürkert GmbH & Co. KG

1803/11\_EU-en\_00891909