

INSERTION flowmeter with paddle wheel, ELEMENT design



- Up to PN10, size of measurement pipes: DN20 to DN400
- Configurable outputs: one or two transistor output(s) and one or two 4...20 mA analog output(s)
- Removable backlit display/configuration module for indication of flow rate and volume with two flow totalizers
- Automatic calibration using Teach-In, all outputs can be checked without the need for actual flow

Type 8026 can be combined with...



Type S020
INSERTION fitting



Type 8619
multiCELL transmitter/controller



Type 8611
Universal process controller eCONTROL

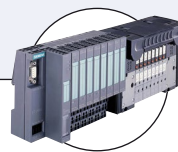

Type 8644
Valve islands



Type 2101 (8692)
ELEMENT control valve system



Type 2030
On/Off diaphragm valve

The 8026 flowmeter is a compact device, specially designed for measuring the flow rate in solid-free liquids, in a variety of applications (water, waste water monitoring, chemical processing etc.).

Type 8026 is available with:

- 2 configurable outputs: one transistor output (NPN) and one 4...20 mA current output (2-wire)
- 3 configurable outputs: two transistor outputs (NPN/PNP) and one 4...20 mA current output (2-wire)
- 4 configurable outputs: two transistor outputs (NPN/PNP) and two 4...20 mA current outputs (3-wire).

Type 8026 converts the measured signal, displays different values in different units (if display/configuration module mounted) and computes the output signals, which are provided via one or two M12 fixed connectors. Thanks to 1 or 2 transistor outputs, the flowmeter can be used to switch a solenoid valve, activate an alarm and, thanks to 1 or 2 current outputs, establish one or two control loops.

General data	
Compatibility	Any pipe from DN20*...DN400 which are fitted out with Bürkert INSERTION Fitting S020 (see corresponding data-sheet)
Materials	See exploded view, on next page
Housing	Stainless steel 1.4404, PPS
Cover	PC
Seals	EPDM, silicone
Screws	Stainless steel
Fixed connector mounting plate	Stainless steel 1.4404 (316L)
Fixed connector	Brass nickel plated (stainless steel on request)
Display/configuration module	PC
Navigation key	PBT
Nut	PC
Wetted parts	PVDF
Sensor holder	FKM standard (EPDM included, but not mounted)
Seal	Ceramics (Al ₂ O ₃)
Axis and bearings	PVDF
Paddle wheel	
Display/configuration module (accessories)	Grey dot matrix 128 x 64 with backlighting
Electrical connections	
2 or 3 outputs transmitter	1 x 5 pin M12 male fixed connector
4 outputs transmitter	1 x 5 pin M12 male and 1 x 5 pin M12 female fixed connectors
Connection cable	Shielded cable
Environment	
Ambient temperature	-10...+60 °C (+14...+140 °F) (operating and storage)
Relative humidity	≤85 %, without condensation

* restricted to some fitting process connections

8026 ELEMENT

bürkert

Complete device data (Pipe + flowmeter)	
Pipe diameter	DN20...DN400
Measuring range	0.3...10 m/s
Fluid temperature with fitting in PVC/ PP PVDF, brass or stainless steel	0...+50 °C (+32...+122 °F) / 0...+80 °C (+32...+176 °F) -15...+100 °C (+5...+212 °F)
Fluid pressure max.	PN10 (145 PSI) - see pressure/temperature chart
Viscosity / Particles rate	300 cSt max. / 1 % max.
Measurement deviation ²⁾ Teach-In Standard K-factor	±1 % of the measured value (at Teach-In flow rate value) ¹⁾ ±2.5 % of the measured value ¹⁾
Linearity	±0.5 % of F.S.* ¹⁾
Repeatability	±0.4 % of the measured value ¹⁾
Electrical data	
Power supply 2 or 3 outputs transmitter (2-wire) 4 outputs transmitter (3-wire)	14...36 V DC, filtered and regulated 12...36 V DC, filtered and regulated
Characteristics of the power source (not provided) of UL recognized devices	Limited power source (according to § 9.4 of the UL61010-1 standard) or, Class 2 type power source (according to the 1310/1585 and 60950-1 standards)
Current consumption with sensor 2 or 3 outputs transmitter (2-wire) 4 outputs transmitter (3-wire)	≤ 1 A (with transistors load) ≤ 25 mA (at 14 V DC without transistors load, with current loop) ≤ 5 mA (at 12 V DC without transistors load, without current loop)
Power consumption	40 W max.
Protection	Reversed polarity of DC: protected Voltage peak: protected Short circuit: protected for transistor outputs
Output	
Transistor 1 transistor output (Transmitter 2-wire)	NPN, open collector, 1...36 V DC, max. 700 mA
2 transistor outputs (Transmitter 2 or 3-wire)	Adjustable as sourcing or sinking (respectively both as PNP or NPN), open collector, max. 700 mA, 0.5 A max. per transistor if the 2 transistor outputs are wired NPN-output: 1...36 V DC PNP-output: Power supply
Current	4...20 mA adjustable as sourcing or sinking (in the same mode as transistor), max. loop impedance: 1100 Ω at 36 V DC; 610 Ω at 24 V DC; 180 Ω at 14 V DC
1 current output (Transmitter 2-wire)	
2 current outputs (Transmitter 3-wire)	max. loop impedance: 1100 Ω at 36 V DC; 610 Ω at 24 V DC; 100 Ω at 12 V DC
Uncertainty of measurement (4...20 mA output)	±1 % of range
Standards, directives and certifications	
Protection class	IP65, IP67 (according to EN60529), NEMA 4X (according to NEMA250) with device wired and M12 cable plug mounted and tightened and cover fully screwed down
Standards and directives CE	The applied standards, which verify conformity with the EU Directives, can be found on the EU Type Examination Certificate and/or the EU Declaration of conformity (if applicable) Complying with article 4, §1 of 2014/68/EU directive*
Pressure	
Certification UL-Recognized for US and Canada 	UL61010-1 + CAN/CSA-C22.2 No.61010-1

¹⁾ Under reference conditions i.e. measuring fluid = water, ambient and water temperature = 20 °C (68 °F), while maintaining the minimum inlet and outlet distances and the appropriate internal diameter of the pipes.

* F.S. = Full scale (10 m/s)

²⁾ = "measurement bias" as defined in the standard JCGM 200:2012

 If the device is mounted in a humid environment or outside, then the maximum voltage allowed is **35 V DC** instead of 36 V DC.

Pressure/temperature chart

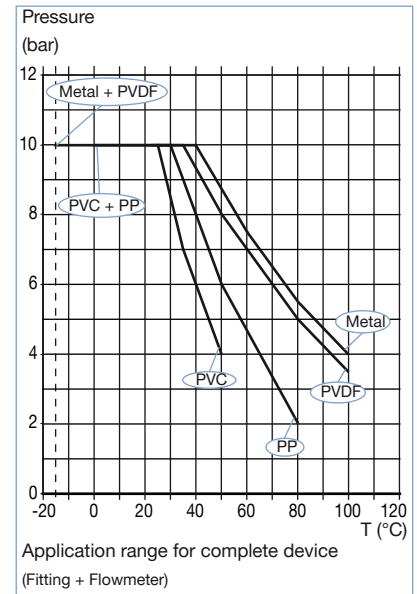

Materials view

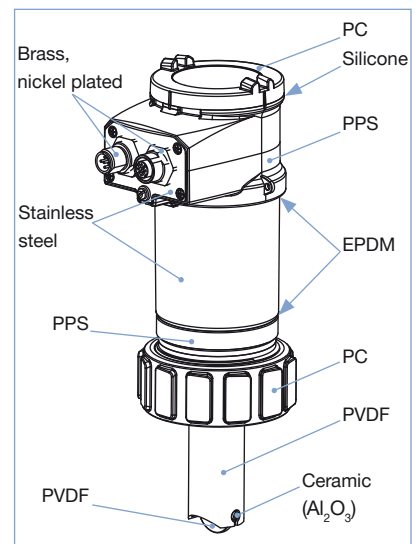

* For the 2014/68/EU pressure directive, the device can only be used under the following conditions (depends on max. pressure, pipe diameter and fluid).

Type of Fluid	Conditions
Fluid group 1, article 4, §1.c.i	DN ≤ 25
Fluid group 2, article 4, §1.c.i	DN ≤ 32 or PN*DN ≤ 1000
Fluid group 1, article 4, §1.c.ii	DN ≤ 25 or PN*DN ≤ 2000
Fluid group 2, article 4, §1.c.ii	DN ≤ 200 or PN ≤ 10 or PN*DN ≤ 5000

Design and operating principle

The device is equipped with a sensor with a paddle wheel, available in long or short version (dependent on the size of the used fitting). This sensor holder is plugged-in and pinned to an enclosure with cover containing the electronic module. A removable display/configuration module completes this flowmeter. The flowmeter can operate without the display/configuration module, but it will be required for configuration of the device (i.e. set parameters, restore default parameters, configure information to be displayed, enter access codes, adjust 4...20 mA output(s) ...) and also for visualizing continuously the measured and processed data.



When liquid flows through the pipe, the paddle wheel with 4 inserted magnets is set in rotation, producing a measuring signal in the sensor (Hall sensor). The frequency modulated induced voltage is proportional to the flow velocity of the fluid.

A conversion coefficient (K-factor, available in the instruction manual of the S020 fitting), specific to each pipe (size and material) enables the conversion of this frequency into a flow rate.

The electronic component converts the measured signal into several outputs (according to the flowmeter version) and displays the actual value. Totalizers are used to obtain the volume of fluid passed through the pipe.

Installation

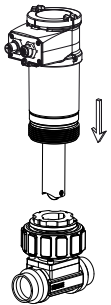

The 8026 flowmeter can easily be installed into any Bürkert INSERTION fitting system (s020), by just fixing the main nut.

Minimum straight upstream and downstream distances must be observed. According to the pipe's design, necessary distances can be bigger or use a flow conditioner to obtain the best accuracy. For more information, please refer to EN ISO 5167-1.

EN ISO 5167-1 prescribes the straight inlet and outlet distances that must be complied with when installing fittings in pipe lines in order to achieve calm flow conditions. The most important layouts that could lead to turbulence in the flow are shown below, together with the associated prescribed minimum inlet and outlet distances.

These ensure calm, problem-free measurement conditions at the measurement point.

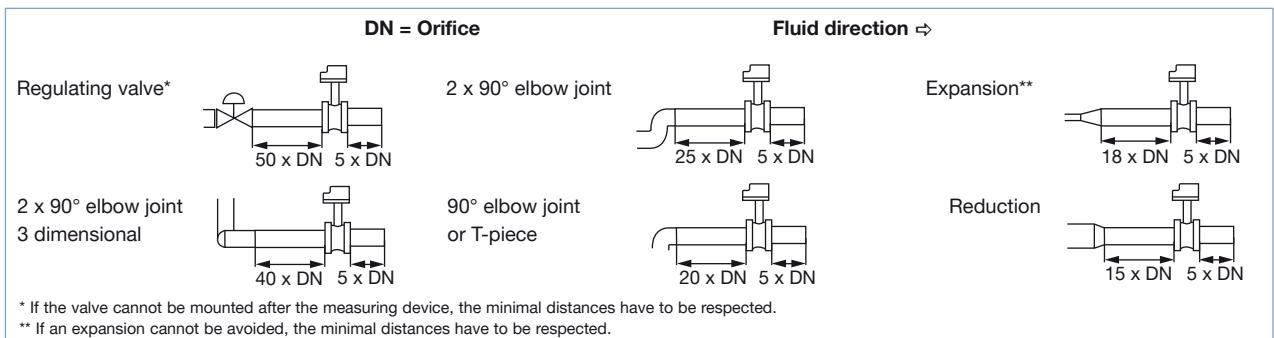

The flowmeter can be installed into either horizontal or vertical pipes..

Important criteria for this are; ensure that the measurement pipe is fully filled and that the measurement pipe is air bubble free.

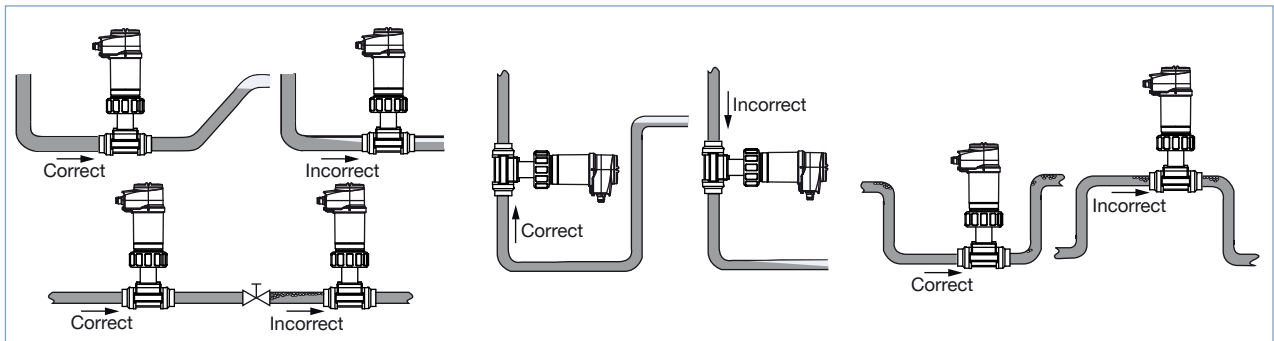

Pressure and temperature ratings must be respected according to the selected fitting material. The suitable pipe size is selected using the diagram Flow/Velocity/DN. The flowmeter is not designed for gas and steam flow measurement.

Diagram flow rate/velocity/DN

Example:

- Specification of nominal flow: 10 m³/h
- Ideal flow velocity: 2...3 m/s

For these specifications, the diagram indicates a pipe size of DN40 (or DN50 for (*) mentioned fittings)

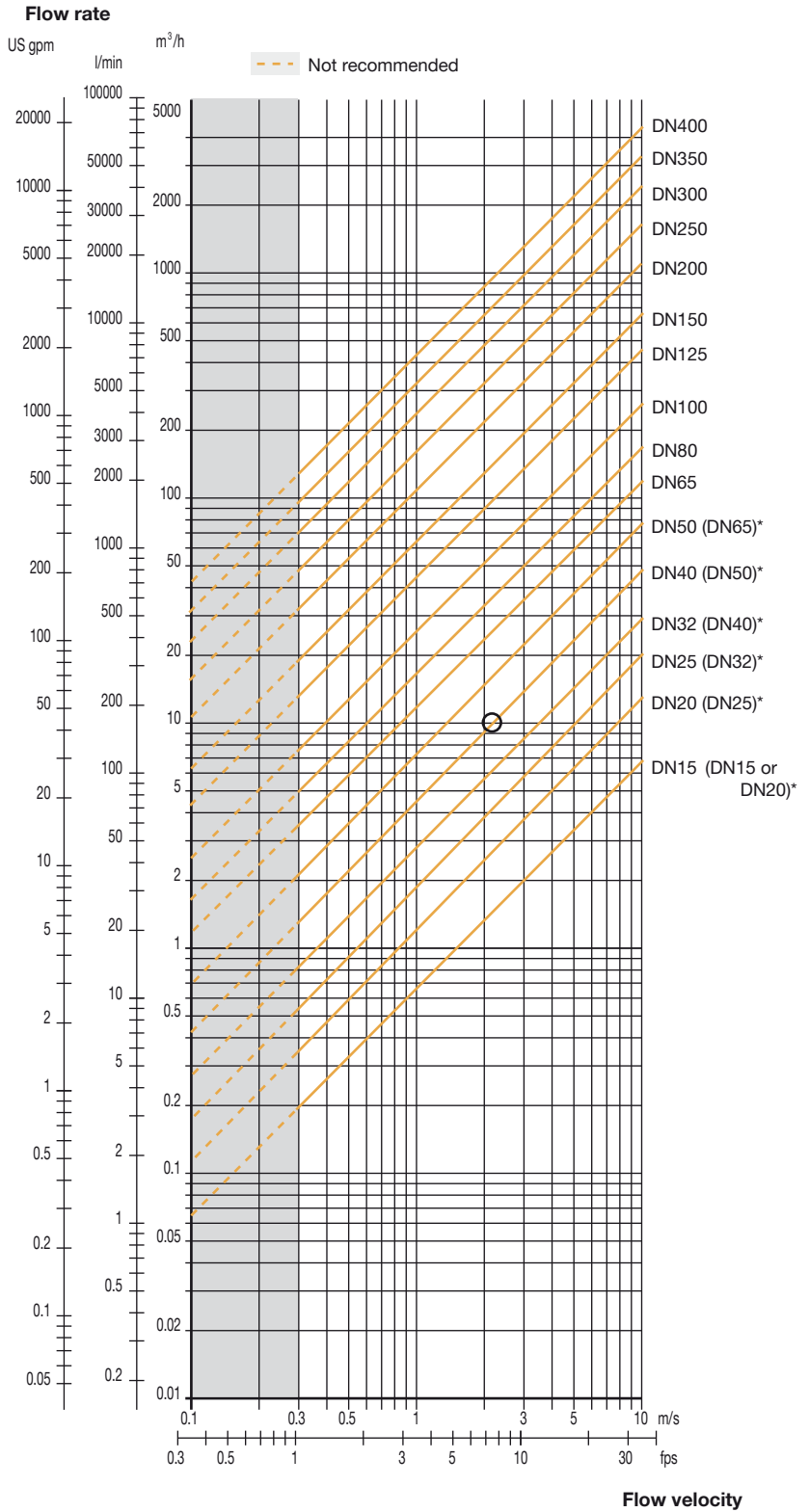

* for following fittings with:

- external threads acc. to SMS 1145
- weld ends acc. to SMS 3008, BS4825-1/ASME BPE/DIN 11866 series C or DIN 11850 series 2/DIN 11866 series A/DIN EN 10357 series A
- Clamp acc. to SMS 3017, BS 4825-3/ASME BPE or DIN 32676 series A

Dimensions [mm] of 8026 flowmeter

Flowmeter

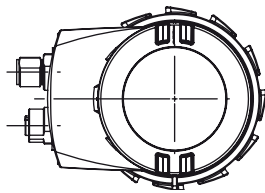
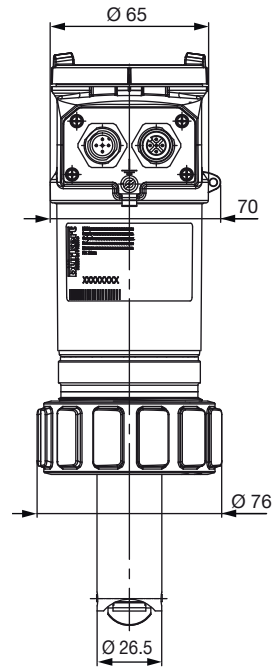
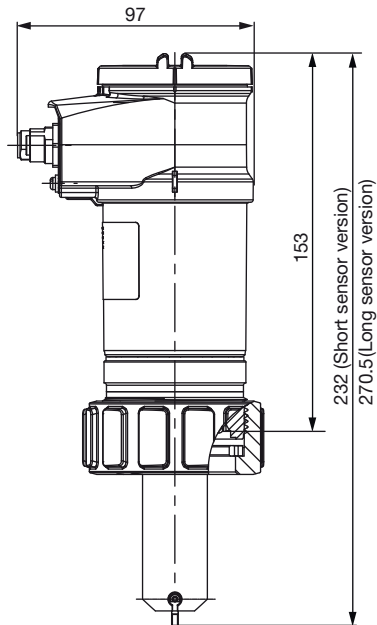

Flowmeter with S020 fitting

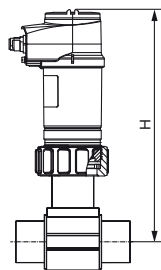

DN	H with S020 fitting			
	T-Fitting	Saddle	Plastic spigot	Metal spigot
20	231.5			
25	231.5			
32	234.5			
40	238.5			
50	244.5	269.5		239.5
65	244.5	267.5	252.5	245.5
80		272.5	258.5	250.5
100		277.5	265.5	260.5
110		273.5		
125		280.5	300.5	271.5
150		250.5	307.5	282.5
180		314.5		
200		326.5	328.5	303.5
250			346.5	363.5
300			358.5	382.5
350			371.5	394.5
400			386.5	

Ordering information for compact 8026 flowmeter

A complete 8026 flowmeter with integrated paddle wheel sensor consists of a compact 8026 flow ELEMENT flowmeter, a removable display/configuration module and a Bürkert S020 INSERTION fitting.

The following information is necessary for the selection of a complete device:

- **Article no.** of the desired compact **8026** flowmeter (see ordering chart on p. 7)
- **Article no.** of the selected **S020** INSERTION fitting (see separate datasheet)

You have to order the two components separately.



Attention!

When you order devices without the display/configuration module, please take care that you also order at least one display/configuration module for the operation.

Article no. of the removable display/configuration module (see ordering chart on p.7)

When you click on the orange box "More info.", you will come to our website for the resp. product where you can download the datasheet.

Example

Compact 8026 flowmeter with display/configuration module



Compact 8026 flowmeter without display/configuration module



Removable display/configuration module



S020 INSERTION fitting



Complete 8026 flowmeter



Ordering chart for compact 8026 flowmeter

Specification	Voltage supply	Output	Sensor version	Electrical connection	UL certification	Article no. without display/ configuration module	Article no. with display/ configuration module
2 outputs	14...36 V DC	1 x transistor NPN + 1 x 4...20 mA (2 wires)	Short	5 pin M12 male fixed connector	No	560860	561860
					Recognized	560863	561863
			Long	5 pin M12 male fixed connector	No	560870	561870
					Recognized	560873	561873
3 outputs	14...36 V DC	2 x transistors NPN/PNP + 1 x 4...20 mA (2 wires)	Short	5 pin M12 male fixed connector	No	560861	561861
					Recognized	560864	561864
			Long	5 pin M12 male fixed connector	No	560871	561871
					Recognized	560874	561874
4 outputs	12...36 V DC	2 x transistors NPN/PNP + 2 x 4...20 mA (2 wires)	Short	5 pin M12 male and 5 pin M12 female fixed connectors	No	560862	561862
					Recognized	560865	561865
			Long	5 pin M12 male and 5 pin M12 female fixed connectors	No	560872	561872
					Recognized	560875	561875

Note: FKM seal in standard; 1 Kit including a green FKM seal, a black EPDM seal and a mounting instruction sheet is supplied with each flowmeter.

Note: Order separately (see accessories)

– M12 cable plugs (only female for one 4...20 mA output, 1 male + 1 female for two 4...20 mA outputs flowmeter)

Ordering chart - accessories (has to be ordered separately)

Specification	Article no.
Removable display/configuration module (with instruction sheet)	559168
Blind cover with seal (1 screw cover with EPDM seal + 1 quarter turn closing cover with silicone seal)	560948
Transparent cover with seal (1 screw cover with EPDM seal + 1 quarter turn closing cover with silicone seal)	561843
Ring	619205
Nut	619204
Set with 1 green FKM and 1 black EPDM seal	552111
5 pin M12 female straight cable plug with plastic threaded locking ring, to be wired	917116
5 pin M12 male straight cable plug with plastic threaded locking ring, to be wired	560946
5 pin M12 female straight cable plug moulded on cable (2 m, shielded)	438680
5 pin M12 male straight cable plug moulded on cable (2 m, shielded)	559177

Interconnection possibilities with other Bürkert devices

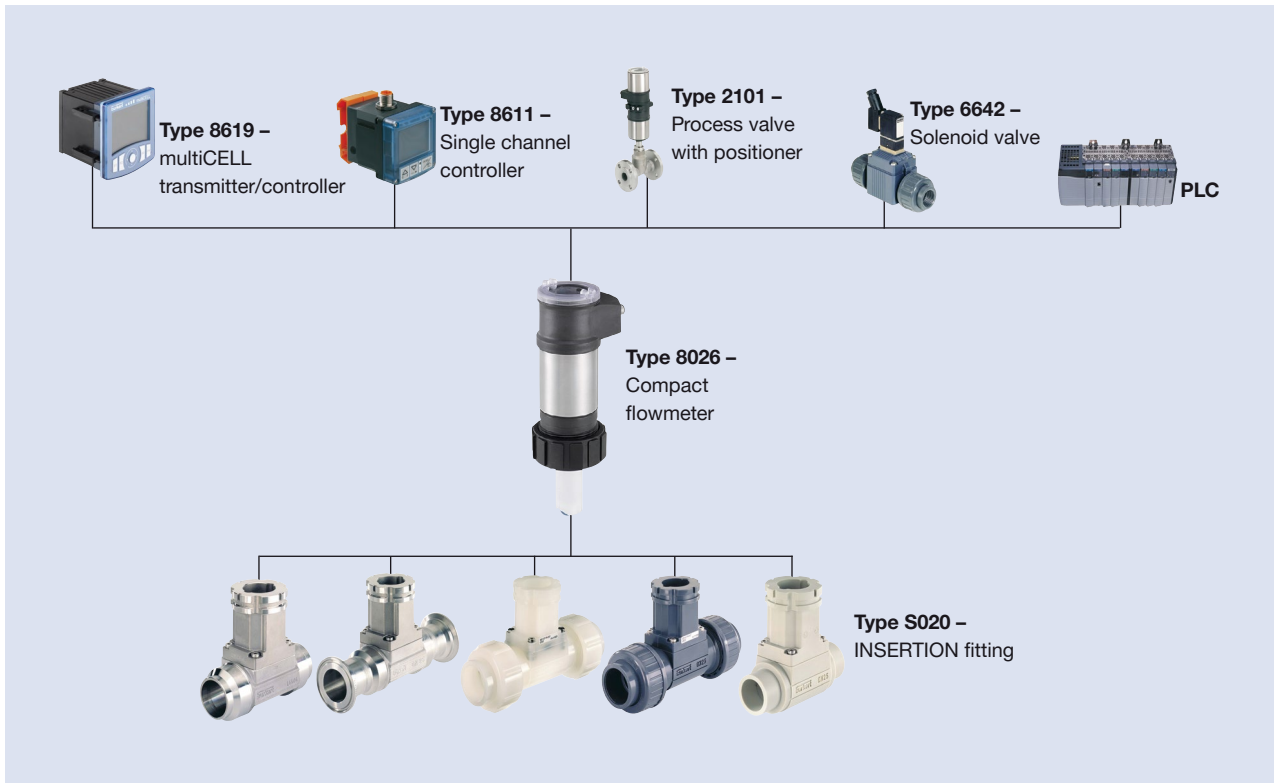

DTS 1000128706 EN Version: L Status: RL (released | freigegeben | validé) printed: 12.03.2018

To find your nearest Bürkert facility, click on the orange box →

www.burkert.com

In case of special application conditions,
please consult for advice.

Subject to alteration.
© Christian Bürkert GmbH & Co. KG

1803/12_EU-en_00895129