

Type 8012 can be combined with...

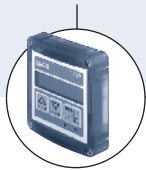

#### Type 8025

Remote flow universal transmitter



#### Type 2712 (8630)

Continuous TopControl System

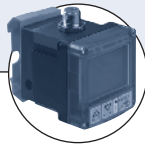

#### Type 8611

PI Flow-Controller

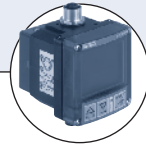

#### Type 8032

Remote flow controller

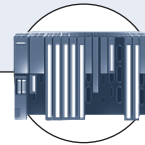

#### PLC

## Flow sensor for continuous flow measurement

- Economic integration in pipe systems without any additional piping
- Measuring principle: optical or magnetic
- Programmable output: 1 analog 4-20 mA and/or 1 transistor output (frequency or switch)
- Outputs programmable through interface on USB port (PC)

The paddle-wheel flow sensor for continuous flow measurement is especially designed for use in neutral, slightly aggressive, solid free liquids in its magnetic measuring version and for use in liquids which let pass the infra-reds in its optic measuring version. The sensor is made up of a fitting (Type S012) and an electronic module (Type SE12) connected together with screws. The Bürkert designed fitting system ensures simple installation of the sensor into all pipes from DN 06 to 50. It can also be installed in fluid block systems.

The sensor produces a programmable frequency pulse signal, proportional to the flow rate, which can easily be transmitted and processed by a Bürkert remote transmitter/indicator (type 8025/8032), or a programmable switch output or a 4-20 mA signal.

General data	
<b>Compatibility</b>	with fittings S012
<b>Materials</b>	
Housing	PPS
Cable plug M12 (gland on request)	PA
<b>Materials wetted parts</b>	
Fitting	Brass, stainless steel 1.4404/316L, PVC, PP or PVDF
Paddle-wheel, holder	PVDF
Axis and bearing	Ceramics (Al <sub>2</sub> O <sub>3</sub> )
Seal	FKM (EPDM option)
<b>Electrical connection</b>	Cable plug M12-5pin (or with 1 m cable length, on request)
<b>Connection cable</b>	1.5 mm <sup>2</sup> max. cross-section

Complete device data (fitting + electronic module)	
<b>Pipe diameter</b>	1/4" to 2" (DN 06 to 50)
<b>Measuring range</b>	1.0 f/s to 32.8 f/s (0.3 m/s to 10 m/s)
<b>Measuring element</b>	optical (or magnetical paddle-wheel, on request)
<b>Medium temperature with</b>	
PVC fitting	32°F up to 140°F (0°C up to 60°C)
PP fitting	32°F up to 176°F (0°C up to 80°C)
St.st., brass or PVDF fitting	5°F up to 212°F (-15°C up to 100°C) (if T <sup>ambient</sup> ≤ 113°F (45°C)) or 5°F up to 194°F (-15°C up to 90°C) (if 113°F (45°C) ≤ T <sup>ambient</sup> ≤ 140°F (60°C))
<b>Fluid pressure max.</b>	145 PSI (PN10) (with plastic fitting) 232 PSI (PN16) (with metal fitting)
<b>Viscosity / Solid particles rate</b>	300 cSt. max. / max. 1% (size of particles 0.5 mm max.)
<b>Accuracy</b>	with standard K-factor ≤ ±(0.5% of FS.* + 2.5% of Reading) <sup>1)</sup>
<b>Linearity</b>	≤ ±0.5% of FS.* (at 10 m/s)
<b>Repeatability</b>	≤ ±0.4% of Reading <sup>1)</sup>

\* FS. = Full scale (10 m/s)

1) Under reference conditions i.e. measuring fluid = water, ambient and water temperature = 68°F (20°C), applying the minimum inlet and outlet pipe straight, matched inside pipe dimensions.

Electrical data	
<b>Power supply (V+)</b>	12-36 V DC
<b>Current consumption</b>	< 60 mA (at 12 V DC for current version - without load)
<b>Reversed polarity of DC</b>	Protected
<b>Voltage peak</b>	Protected
<b>Short circuit</b>	Protected for transistor output
<b>Output</b>	
Transistor version	Transistor NPN (default setting) / PNP (programmable on request), open collector, max. 700 mA, output NPN: 0.2-36 V DC (default setting) output PNP: V+ power supply frequency or switching mode
Current version (programmable on request)	4-20 mA, sinking (default setting), image of flow velocity (default setting), programmable on request (sourcing mode); Loop impedance max.: 1125 Ω at 36 V DC; 650 Ω at 24 V DC; 140 Ω at 12 V DC

Environment	
<b>Ambient temperature</b>	5°F up to 140°F (-15°C up to +60°C) (operating and storage)
<b>Relative humidity</b>	≤ 80%, non condensated

Standards and approvals	
<b>Protection class</b>	IP67 with Multipin M12 (IP65 with cable)
<b>Standard</b>	
EMC	EN 61000-6-3, EN 61000-6-2
Vibration	EN 60068-2-6
Shock	EN 60068-2-27
<b>Approval / Certificate on request</b>	3.1 Certificate; 2.2 Certificate; Rugosity Certificate; Calibration Certificate; FDA (with EPDM seal) - stainless steel fitting only

Accuracy diagram

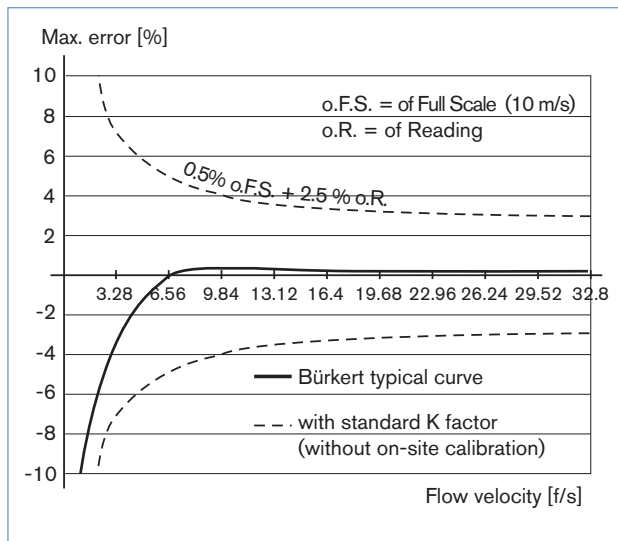

Pressure / temperature chart

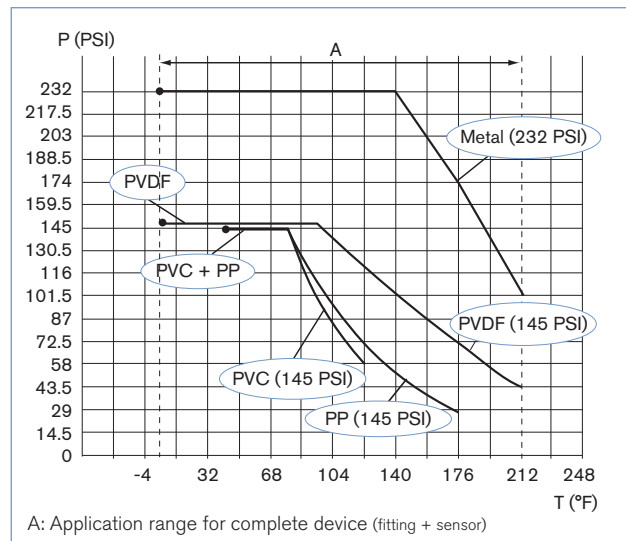

DTS 1000090219 EN Version: A Status: RL (released | freigegeben | validé) printed: 10.01.2018

## Main features

### 8012 with optical (standard) or magnetical (on request) principle

#### Version with Transistor output

- ▶ Transistor output: NPN (standard) or PNP (on request) mode.
- ▶ With one programmed transistor output mode (4 possibilities)
  - Raw frequency (2 pulses per paddle-wheel rotation) (standard)
  - Proportional frequency (1 pulse every determined volume) (on request)

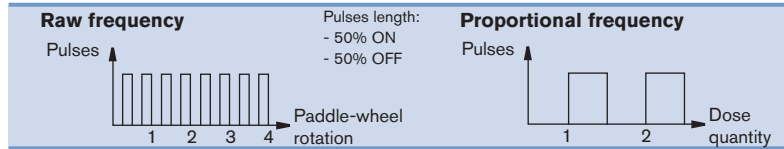

- Switching mode
  - 2 switching modes for the output, either hysteresis or window, inverted or not, depending on transistor output version
  - Programmable delay before switching

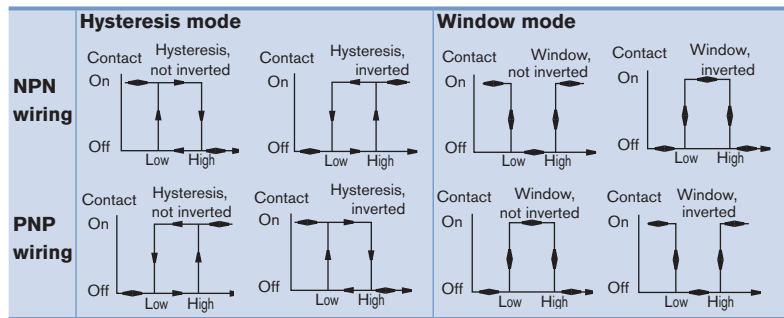

- Detection of flow direction - only with optical principle.

#### Version with Transistor and current outputs

##### Transistor output:

- ▶ Same features described as above

##### Current output:

- ▶ with sinking (standard) or sourcing (on request) wiring
- ▶ 8012 with programmable current output
  - 4-20 mA current corresponding to paddle-wheel frequency (0-250 Hz) (standard)
  - 4-20 mA current corresponding to a flow range (on request)

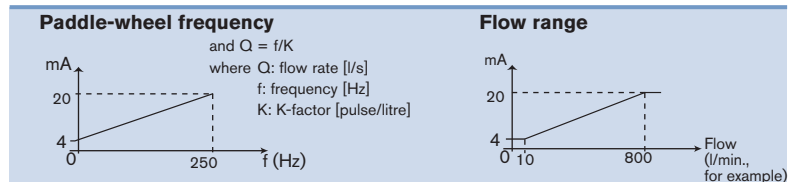

- Damping of fluctuation of current output through filter function
- Generation of an alarm current (22 mA) - when fluid circulation is opposite to the direction indicated by the arrow on the side of the housing (only versions with optical principle) or when full scale has been exceeded (versions with optical or magnetical principle).

## Design and principle of operation

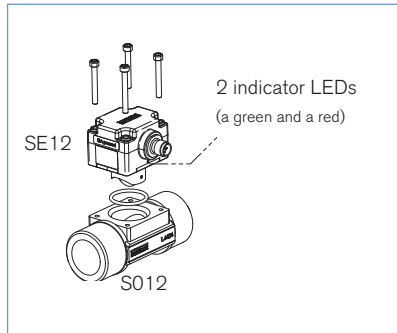

The flow sensor 8012 is built up with an electronic module SE12 with integrated measurement paddle-wheel associated to a fitting S012. This connection is made by means of screws. In a 3-wire system, the signal can be displayed or processed directly. The output signal is provided via a cable plug M12-5 pin.

When liquid flows through the pipe, the paddle-wheel is set in rotation producing a measuring signal in the transducer. Two electronic module versions allow the following outputs:

- with one pulse output (either NPN or PNP transistor output - programmable). An external power supply of 12-36 V DC is required. This pulse output generates a signal which frequency is proportional to the flow velocity. It is designed for connection to any system with open collector NPN or PNP frequency input.

- with one 4-20 mA current output and one pulse output (either NPN or PNP transistor output programmable). An external power supply of 12-36 V DC is required. The 4-20 mA output delivers a current which value is the image of the flow velocity.

The electronic module SE12 is equipped with 2 indicator LEDs, visible by transparency under the cable plug (standard) or on the opposite side of the cable plug (on request). When the device is energized, the green indicator LED lights up and then flashes proportionally to the rotation frequency of the paddle-wheel. The switch on of the red indicator LED indicates a malfunction of the device.

## Installation

Minimum straight upstream and downstream distances must be observed. According to the pipe's design, necessary distances can be bigger or use a flow conditioner to obtain the best accuracy. For more information, please refer to EN ISO 5167-1.

EN ISO 5167-1 prescribes the straight inlet and outlet distances that must be complied with when installing fittings in pipe lines in order to achieve calm flow conditions. The most important layouts that could lead to turbulence in the flow are shown below, together with the associated prescribed minimum inlet and outlet distances. These ensure calm, problem-free measurement conditions at the measurement point.

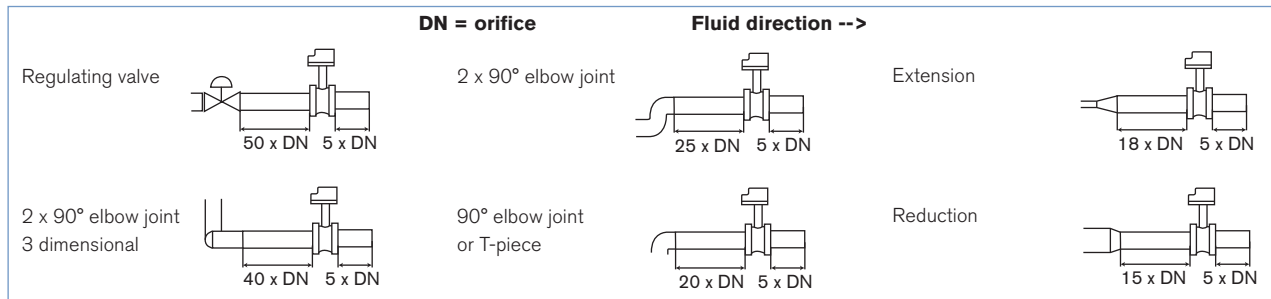

The flow rate sensor can be installed in either horizontal or vertical pipes, but following additional conditions should be respected:

- always install the 8012 so that the paddle-wheel axis is horizontal.
- ensure the pipe is maintained full at all times, near the sensor
- ensure the pipe design does not allow the build-up of air bubbles or cavities within the medium, near the sensor

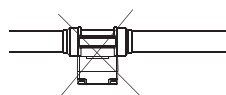
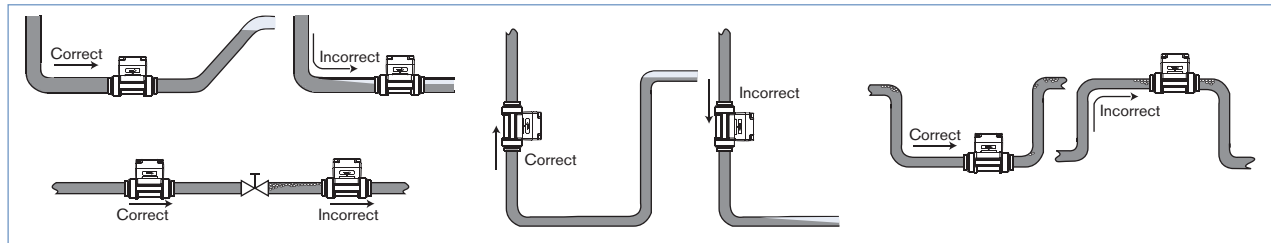

When installing the 8012 on a horizontal pipe, make sure the paddle-wheel is oriented down

Pressure and temperature ratings must be respected according to the selected fitting material.

The suitable pipe size is selected using diagram Flow / Velocity / DN.

The sensor is not designed for gas flow measurement.

### Selection of fitting / pipe size

**Example:**

- specification of nominal flow: 50 GPM
- ideal flow velocity: 6...8 f/s
- for these specifications, the diagram indicates a pipe size of 1 1/2" (DN40) [or 2" (DN50) for (\*) mentioned fittings]

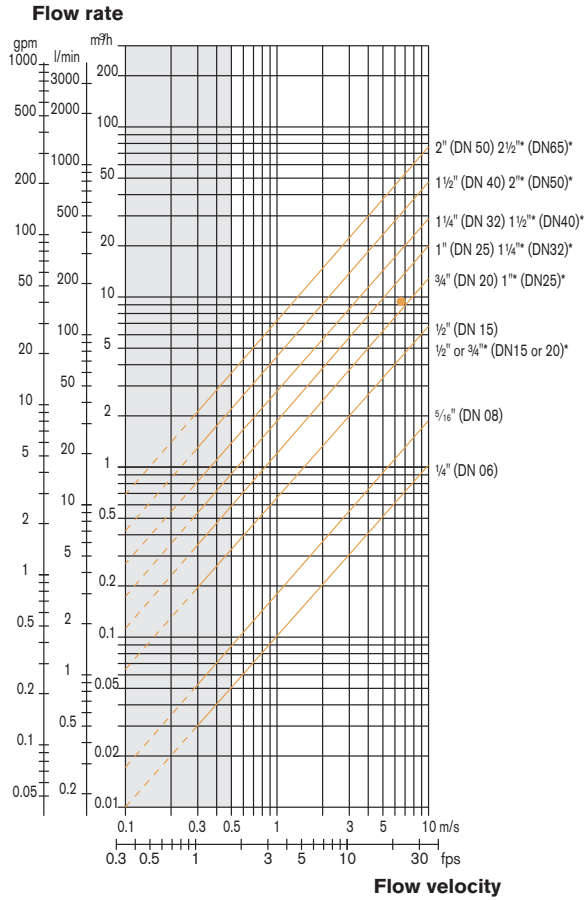

- \* for following fittings:**
- with external threads acc. to SMS 1145
  - with weld-ends acc. to SMS 3008, BS 4825 / ASME BPE or DIN 11850 Series 2
  - TriClamp® acc. to SMS 3017 / ISO 2852, BS 4825 / ASME BPE or DIN 32676

Tri-Clamp® is a registered Trademark of Alfa Laval Inc.

### Dimensions electronic module SE12 [mm]

**Electronic module SE12**

with M12-5 pin cable plug

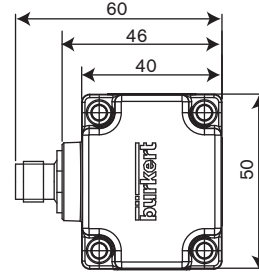

with cable (on request)

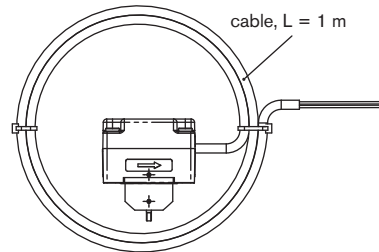
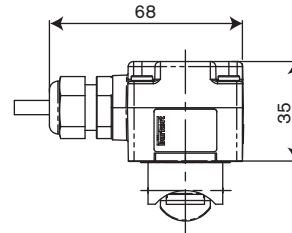

Dimensions sensor 8012

**8012 with internal thread connection**

G, NPT, Rc  
in stainless steel (316L - 1.4404) or  
brass (CuZn39Pb2)

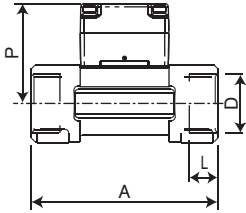

DN [mm]	P [mm]	A [mm]	D [inch]	L [mm]
15	57.5	84.0	G 1/2	16.0
			NPT 1/2	17.0
			Rc 1/2	15.0
20	55.0	94.0	G 3/4	17.0
			NPT 3/4	18.3
			Rc 3/4	16.3
25	55.2	104.0	G 1	23.5
			NPT 1	18.0
			Rc 1	18.0
32	58.8	119.0	G 1 1/4	23.5
			NPT 1 1/4	21.0
			Rc 1 1/4	21.0
40	62.6	129.0	G 1 1/2	23.5
			NPT 1 1/2	20.0
			Rc 1 1/2	19.0
50	68.7	148.5	G 2	27.5
			NPT 2	24.0
			Rc 2	24.0

**8012 with external thread connection**

G, NPT  
in stainless steel (316L - 1.4404),  
brass (CuZn39Pb2) or PVC

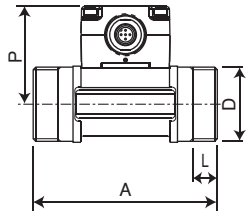

DN [mm]	P [mm]	A [mm]	D [inch]	[mm]	L [mm]
06	52.5	90.0	G 1/4 or 1/2	-	14.0
08	52.5	90.0	G 1/2	M16 x 1.5	14.0
			NPT 1/2		
			Rc 1/2		

**8012 with True union connection**

acc. to DIN 8063, ASTM, JIS  
in PVC

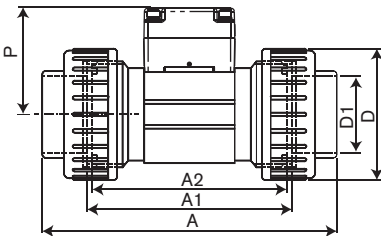

DN [mm]	P [mm]	D [mm]	A DIN 8063	ASTM	JIS	D1 DIN 8063	ASTM	JIS	A2 [mm]	A1 [mm]
15	57.5	43	128	130.0	129	20	21.3	18.40	90	96
20	55.0	53	144	145.6	145	25	26.7	26.45	100	106
25	55.2	60	160	161.4	161	32	33.4	32.55	110	116
32	58.8	74	168	170.0	169	40	42.2	38.60	110	116
40	62.6	83	188	190.2	190	50	48.3	48.70	120	127
50	68.7	103	212	213.6	213	63	60.3	60.80	130	136

## Ordering chart for sensor Type 8012 with optical measuring method, 12-36 V DC, M12-5pin

Port connection	Standard	Output*	Item no. DN 1/4" 1/4" port	Item no. DN 1/4" 1/2" port	Item no. DN 5/16" 1/2" port	Item no. 1/2" (DN15) 1/2" port	Item no. 3/4" (DN20) 3/4" port	Item no. 1" (DN25) 1" port	Item no. 1 1/4" (DN32) 1 1/4" port	Item no. 1 1/2" (DN40) 1 1/2" port	Item no. 2" (DN50) 2" port
<b>Brass - Temperature max. 212°F, 232 PSI</b>											
Internal thread	G	Pulse	-	-	-	556 003	556 004	556 005	556 006	556 007	556 008
		Pulse + 4-20 mA	-	-	-	556 012	556 013	556 014	556 015	556 016	556 017
	NPT	Pulse	-	-	-	556 018	556 019	556 020	556 021	556 022	556 023
		Pulse + 4-20 mA	-	-	-	556 024	556 025	556 026	556 027	556 028	556 029
	Rc (ISO7)	Pulse	-	-	-	556 030	556 031	556 032	556 033	556 034	556 035
		Pulse + 4-20 mA	-	-	-	556 036	556 037	556 038	556 039	556 040	556 041
External thread	G	Pulse	556 000	556 001	556 002	-	-	-	-	-	-
	ISO 228	Pulse + 4-20 mA	556 009	556 010	556 011	-	-	-	-	-	-
<b>Stainless steel - Temperature max. 212°F, 232 PSI</b>											
Internal thread	G	Pulse	-	-	-	556 045	556 046	556 047	556 048	556 049	556 050
		Pulse + 4-20 mA	-	-	-	556 054	556 055	556 056	556 057	556 058	556 059
	NPT	Pulse	-	-	-	556 061	556 062	556 063	556 064	556 065	556 066
		Pulse + 4-20 mA	-	-	-	556 068	556 069	556 070	556 071	556 072	556 073
	Rc (ISO7)	Pulse	-	-	-	556 074	556 075	556 076	556 077	556 078	556 079
		Pulse + 4-20 mA	-	-	-	556 080	556 081	556 082	556 083	556 084	556 085
External thread	G	Pulse	556 042	556 043	556 044	-	-	-	-	-	-
		Pulse + 4-20 mA	556 051	556 052	556 053	-	-	-	-	-	-
	NPT	Pulse	-	-	556 060	-	-	-	-	-	-
		Pulse + 4-20 mA	-	-	556 067	-	-	-	-	-	-
<b>PVC - Temperature max. 140°F, 145 PSI</b>											
True union	DIN	Pulse	-	-	-	556 088	556 089	556 090	556 091	556 092	556 093
		Pulse + 4-20 mA	-	-	-	556 094	556 095	556 096	556 097	556 098	556 099
	ASTM	Pulse	-	-	-	556 100	556 101	556 102	556 103	556 104	556 105
		Pulse + 4-20 mA	-	-	-	556 106	556 107	556 108	556 109	556 110	556 111
	JIS	Pulse	-	-	-	556 112	556 113	556 114	556 115	556 116	556 117
		Pulse + 4-20 mA	-	-	-	556 118	556 119	556 120	556 121	556 122	556 123
External thread	G	Pulse	-	556 086	556 124	-	-	-	-	-	-
	ISO 228	Pulse + 4-20 mA	-	556 087	556 125	-	-	-	-	-	-

\* Factory setting:  
 - pulse NPN (raw frequency)  
 - pulse NPN (raw frequency) + 4-20 mA (sinking mode, 0-250 Hz)  
 - other programmations on request



### Further versions on request



#### Port connection

Weld ends, Tri-Clamp®, Flange, spigot... connection



#### Materials

PP, PVDF...

Please also use the "request for quotation" form on page 12 for ordering further version of the sensor Type 8012.

Ordering chart for accessories for sensor Type 8012 (to be ordered separately)

Specifications	Item no.
4 short screws (M4 x 35 - A4) + 4 long screws (M4 x 60 -A4)	555 775
5 pin M 12 female connector moulded on cable (2 m, shielded)	438 680
5 pin M 12 female cable connector with plastic threaded locking ring	917 116
Programming tool TACTIC (1-m length USB cable + 1 TACTIC cable with M12 connection + 1 TACTIC electronic housing + 1 programmation CD)	556 500
Connecting cables: 8012-TACTIC and TACTIC-PC (1-m length USB cable + 1 TACTIC cable with M12 connection)	556 160

Specifications	Item no. 1/4" (DN06)	Item no. 5/16" (DN08)	Item no. 1/2" (DN15)	Item no. 3/4" (DN20)	Item no. 1" (DN25)	Item no. 1 1/4" (DN32)	Item no. 1 1/2" (DN40)	Item no. 2" (DN50)
O-ring set for metal fitting - FKM	426 340	426 340	426 340	426 340	426 340	426 340	426 340	426 340
O-ring set for metal fitting - EPDM	426 341	426 341	426 341	426 341	426 341	426 341	426 341	426 341
O-ring set for plastic fitting - FKM	-	448 679	431 555	431 556	431 557	431 558	431 559	431 560
O-ring set for plastic fitting - EPDM	-	448 680	431 561	431 562	431 563	431 564	431 565	431 566

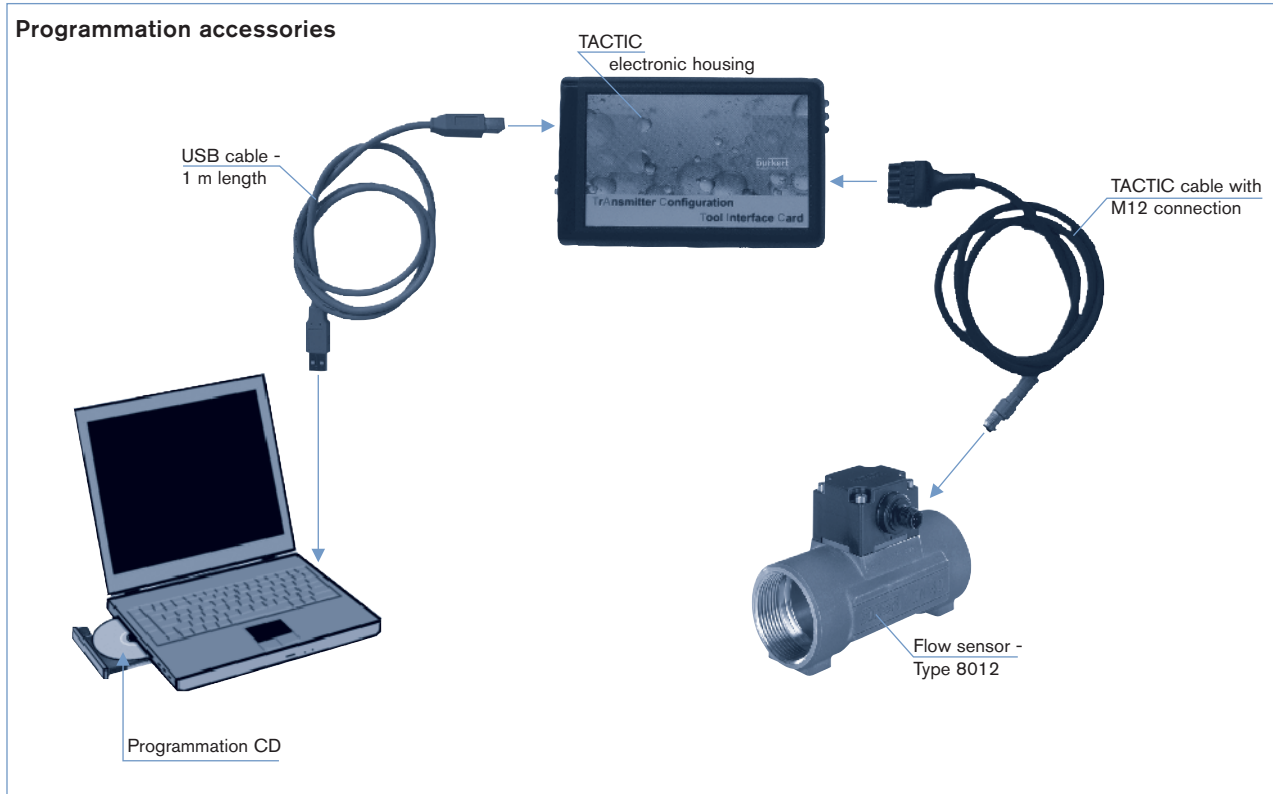

DTS 1000090219 EN Version: A Status: RL (released | freigegeben | validé) printed: 10.01.2018



## Flow sensor Type 8012 possibilities

### A flow sensor Type 8012 consists of:

- a sensor electronic module SE12 with either optical or magnetical measuring principle, with only pulse output or with both pulse and 4-20 mA current outputs - programmed in **standard** (see ordering chart Type SE12) or **customized** (see specifications sheet on last page). The electrical connection is carried out through multipin M12-5 or 1 m cable.
- a fitting Type S012 available in different materials providing many installation options of the sensor electronic module into all pipes, ranging from DN6 to DN50, due to the large range of connections (see specifications sheet on last page).
- screws and O-ring (see left-hand page - ordering chart for accessories).

The following charts indicate the different possibilities:

### Sensor electronic module Type SE12 (standard programmed)

Specifications	Voltage supply	Pipe connection	Output*	Connector	Item no.
Magnetical measuring principle	12-36 V DC	1/4" and 5/16" (DN06 and DN08)	Frequency with pulse NPN	Cable plug M12-5pin	557 054
			Frequency with pulse NPN + 4-20 mA	Cable plug M12-5pin	557 058
			Frequency with pulse NPN	with 1 m cable	557 056
			Frequency with pulse NPN + 4-20 mA	with 1 m cable	557 060
		1/2" to 2" (DN15 to DN50)	Frequency with pulse NPN	Cable plug M12-5pin	557 053
			Frequency with pulse NPN + 4-20 mA	Cable plug M12-5pin	557 057
			Frequency with pulse NPN	with 1 m cable	557 055
			Frequency with pulse NPN + 4-20 mA	with 1 m cable	557 059
Optical measuring principle	12-36 V DC	1/4" and 5/16" (DN06 and DN08)	Frequency with pulse NPN	Cable plug M12-5pin	557 062
			Frequency with pulse NPN + 4-20 mA	Cable plug M12-5pin	557 066
			Frequency with pulse NPN	with 1 m cable	557 064
			Frequency with pulse NPN + 4-20 mA	with 1 m cable	557 068
		1/2" to 2" (DN15 to DN50)	Frequency with pulse NPN	Cable plug M12-5pin	557 061
			Frequency with pulse NPN + 4-20 mA	Cable plug M12-5pin	557 065
			Frequency with pulse NPN	with 1 m cable	557 063
			Frequency with pulse NPN + 4-20 mA	with 1 m cable	557 067

\* Factory setting:  
 - pulse NPN (raw frequency)  
 - pulse NPN (raw frequency) + 4-20 mA (sinking mode, 0-250 Hz)  
 - other programmations on request

### Fitting Type S012 (possibilities version)

Port connection	Materials	Available 1/4" (DN06)	Available 5/16" (DN08)	Available 1/2" (DN15)	Available 3/4" (DN20)	Available 1" (DN25)	Available 1 1/4" (DN32)	Available 1 1/2" (DN40)	Available 2" (DN50)	Available 2 1/2" (DN65)
Internal thread	Brass, stainless steel	-	-	Yes	Yes	Yes	Yes	Yes	-	Yes
External thread	Brass, stainless steel, PVC, PP, PVDF	Yes	Yes	Yes	Yes	Yes	Yes	Yes	Yes	-
	Stainless steel acc. SMS 1145	-	-	-	-	Yes	-	Yes	Yes	-
Weld ends	Stainless steel	-	Yes	Yes	Yes	Yes	Yes	Yes	Yes	Yes
Tri-Clamp®	Stainless steel	-	Yes	Yes	Yes	Yes	Yes	Yes	Yes	Yes
Flange	Stainless steel	-	-	Yes	Yes	Yes	Yes	Yes	Yes	-
	True union	-	-	Yes	Yes	Yes	Yes	Yes	Yes	-
True union	PVC	-	Yes	Yes	Yes	Yes	Yes	Yes	Yes	-
	PP, PVDF	-	-	Yes	Yes	Yes	Yes	Yes	Yes	-
Spigot	PVC, PP, PVDF	-	-	Yes	Yes	Yes	Yes	Yes	Yes	-
		-	-	Yes	Yes	Yes	Yes	Yes	Yes	-

**Note: Such new 8012 configuration should be ordered to your Bürkert Sales Center.**

Interconnection possibilities with the sensor Type 8012

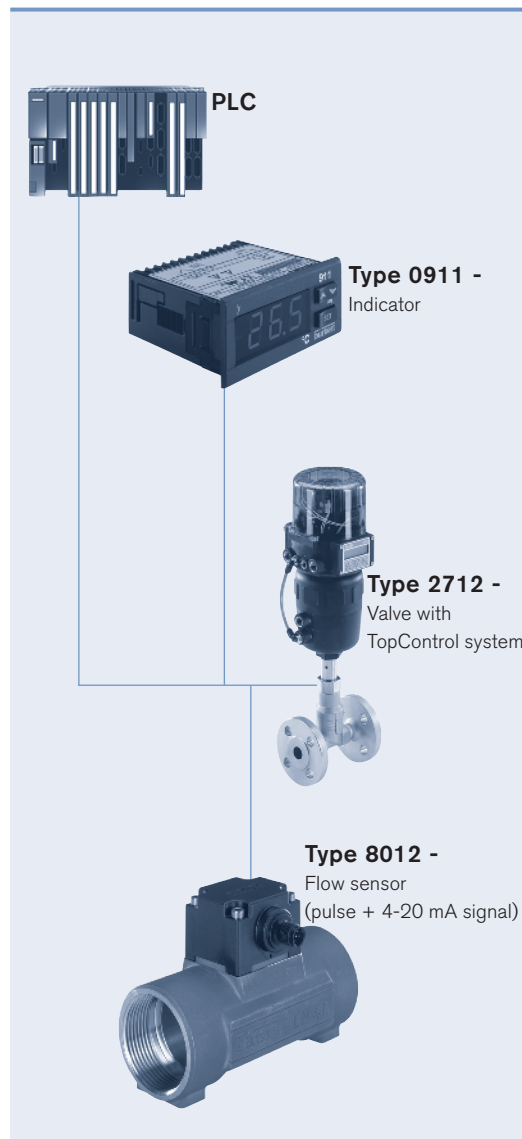
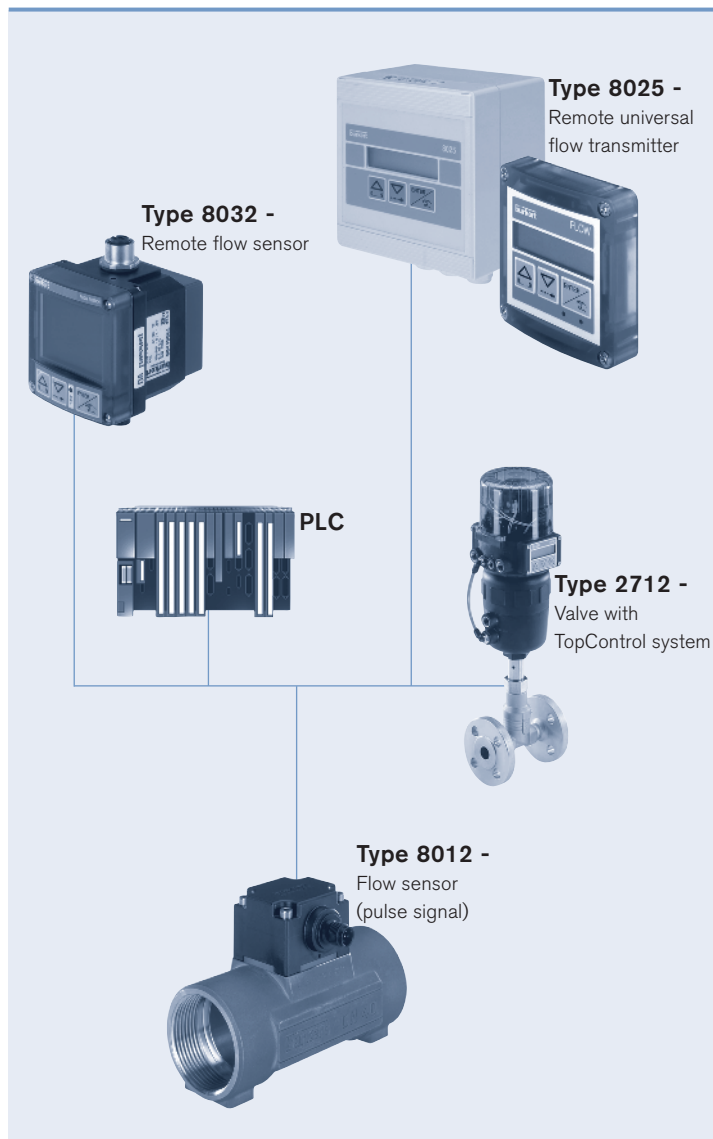

**Fluid block system for the sensor Type 8012**

The modular concept of our sensor electronic module Type SE12 allows fully customized, pre-mounted and tested solutions to completely meet application needs. It is designed for being mounted in a system block, associated with other Bürkert products. This allows cost reduction and compact design for customized solutions.

Please contact your Bürkert local office to have individual counselling and engineering support in order to find the best solution corresponding to your application.

**Example of flow regulation systems with our SE12 electronic module**

**Cooling of molding tools  
in plastic injection machines**

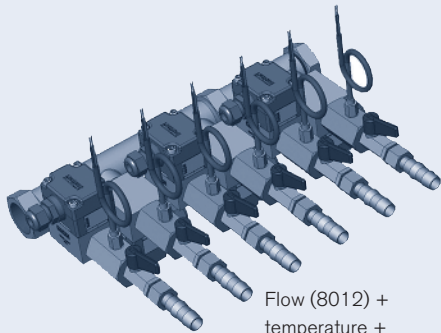

Flow (8012) +  
temperature +  
manual On/Off valve

**Cooling of welding robot  
in automotive industry**

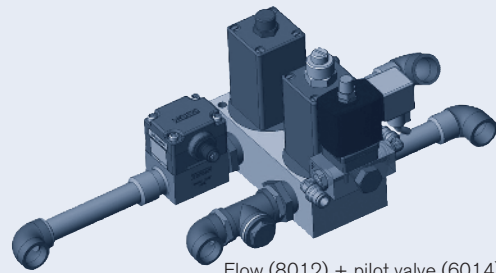

Flow (8012) + pilot valve (6014) +  
On/Off diaphragm valve (0263)

**On/Off control loop**

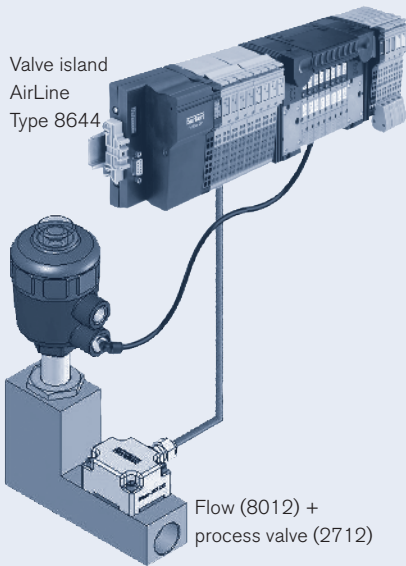

Valve island  
AirLine  
Type 8644

Flow (8012) +  
process valve (2712)

**Filter monitoring in  
waste water treatment**

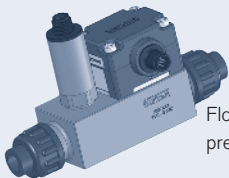

Flow (8012) +  
pressure (8314)

**Flow regulation  
in Ro water treatment skid**

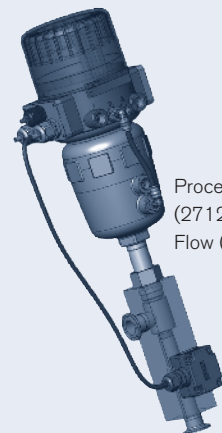

Process valve  
(2712 + 8630) +  
Flow (8012)

DTS 1000090219 EN Version: A Status: RL (released | freigegeben | validé) printed: 10.01.2018

**Sensor Type 8012 - request for quotation**

**Note**  
You can fill out the fields directly in the PDF file before printing out the form.

Please fill in and send to your local Bürkert Sales Centre with your inquiry or order.

Company:	Contact person:
Customer No.:	Department:
Address:	Tel. / Fax.:
Postcode / Town:	E-mail:

**Flow sensor 8012**      **Quantity:**       **Desired delivery date:**

**Fitting S012**

■ **Pipe diameter (DN)**    1/4" (6)    5/16" (8)    1/2" (15)    3/4" (20)    1" (25)    1 1/4" (32)    1 1/2" (40)    2" (50)    2 1/2" (65)

■ **Materials:**

**Body**       Brass       Stainless steel  
 PVC       PP       PVDF

**Seal**       FKM       EPDM

■ **Port connection:**

**Internal thread**    G       NPT       Rc  
**External thread**    G       NPT       Rc  
**Weld ends**       EN ISO 1127/ISO4200       SMS 3008  
 BS4825/ASME BPE       DIN 11850 S2  
**Tri-Clamp®**       ISO (for pipe EN ISO 1127/ISO4200)       SMS 3017/ISO2852  
 BS4825/ASME BPE       DIN 32767  
**Flange**       DIN 2633       ANSI, B16-5-1988       JIS, 10K  
**True union**       DIN 8063       ASTM       JIS  
**Spigot**       DIN 8063

■ **Special rugosity**    without       with      Ra int. =       Ra ext. =

■ **Flow unit** ( will determine the needed volume unit)    l/s       Ga/s       USGa/s  
 l/min       m<sup>3</sup>/min       Ga/min       USGa/min  
 l/h       m<sup>3</sup>/h       Ga/h       USGa/h

**Sensor electronic module SE12**

■ **Measuring method**    Magnetical       Optical  
■ **Electrical connection**    Multipin M12       with 1 m cable  
■ **Output signal**       Transistor (Fill in 1. below)       Transistor & 4-20 mA current (Fill in 1. and 2. below)

**1. Transistor output feature**

■ **Transistor mode**       NPN       PNP

**Output programmed as**

Raw frequency (paddle-wheel rotation)       Proportional frequency ("V" determined volume per pulse)  
V =

Switching mode       Detection of flow direction (only with optical version)

Hysteresis       Window  
 Inverted       Not inverted

■ **Switching threshold value:**  
Low val.   
High val.

■ **Switch. delay**  s (0 to 3276 s)

■ **Switching mode**       Inverted       Not inverted  
Switch. delay  s (0 to 3276 s)

**2. Current output feature**

■ **Wiring mode**       Sinking       Sourcing

**Output programmed as**

4-20 mA current (corresp. to paddle-wheel frequency 0-250 Hz)       4-20 mA current (corresp. to a specific flow range)  
Flow value corresponding to: 4 mA  /20 mA

without filtration       with filtration (1 to 9):   
(filtration level: min. 1; max. 9)

DTS 1000090219 EN Version: A Status: RL (released | freigegeben | validé) printed: 10.01.2018