

## Flowmeter with paddle-wheel for continuous flow measurement

- Economic integration in pipe systems without any additional piping
- Magnetic measuring principle (paddle wheel with hall sensor)
- Output: transistor output (frequency signal)

Type 8011 can be combined with



**Type 8619**

Multifunction transmitter/controller



**Type 2301 (8692/8693)**

TopControl System



**Type 8611**

Universal Controller eControl



**Type 8032**

Flow controller

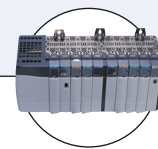

**PLC**

The paddle wheel flowmeter for continuous flow measurement is especially designed for use in neutral, slightly aggressive, solid free liquids. The 8011 is made up of a fitting (S012) and an electronic module (SE11) connected together with screws. The Bürkert designed fitting system ensures simple installation into all pipes from DN06 to DN65. It can also be installed in fluid block systems.

The 8011 produces a frequency signal, proportional to the flow rate, which can be processed by a Bürkert remote transmitter/controller.

The 8011 is available in two versions:

- with one pulse output: transistor NPN
- with two pulse outputs: transistor NPN and PNP.

General data	
<b>Compatibility</b>	with fittings S012 (see ordering chart)
<b>Fitting process connections</b>	Internal or external thread (weld ends, clamp or flange on request) True union or external thread (spigot on request)
<b>Materials</b>	PPS / EPDM PA PVC Brass, stainless steel 1.4404/316L, PVC, PP PVDF blue / PVDF Ceramics (AL <sub>2</sub> O <sub>3</sub> ) / FKM (EPDM option)
<b>Electrical connection</b>	Fixed connector 5 pin M12 (or with 1 m cable via cable gland, on request)
<b>Connection cable</b>	1.5 mm <sup>2</sup> max. cross-section
Complete device data (fitting + electronic module)	
<b>Pipe diameter</b>	DN06...DN50 (DN65 on request)
<b>Measuring range</b>	0.3 ... 10 m/s
<b>Measuring element</b>	magnetic hall sensor
<b>Medium temperature with</b>	0 ... +60 °C / 0 ... +80 °C -15 ... +100 °C (if T <sup>ambient</sup> ≤ 45 °C) or -15 ... +90 °C (if 45 °C ≤ T <sup>ambient</sup> ≤ 60 °C)
<b>Fluid pressure max.</b>	PN10 (with plastic fitting) PN16 (with metal fitting)
<b>Viscosity / Pollution</b>	max. 300 cSt. / max. 1% (size of particles 0.5 mm max.)
<b>Measurement deviation</b>	± 1% of Reading <sup>1)</sup> (at the teach flow rate value) ± 2.5% of Reading <sup>1)</sup>
<b>Linearity</b>	± 0.5% of FS.*
<b>Repeatability</b>	± 0.4% of Reading <sup>1)</sup>

\* FS. = Full scale (10 m/s)

<sup>1)</sup> Under reference conditions i.e. measuring fluid = water, ambient and water temperature = 20 °C, applying the minimum inlet and outlet pipe straights, matched inside pipe dimensions.

Electrical data	
<b>Operating voltage (V+)</b>	4.5 ... 24 V DC, filtered and regulated
One pulse output version	4.5 ... 24 V DC, filtered and regulated
Two pulse outputs version	6 ... 36 V DC, filtered and regulated
<b>Current consumption</b>	< 5 mA (without load)
<b>Reversed polarity of DC</b>	Protected
<b>Voltage peak</b>	Protected
<b>Short circuit</b>	Protected for transistor output
<b>Output</b>	
One pulse output version	Transistor NPN open collector, max. 20 mA, NPN output: 0.2 ... 24 V DC, frequency up to 300 Hz (Frequency [Hz] = K factor [pulse/litre] x flow rate [l/s])
Two pulse outputs version	Transistor NPN and PNP open collector, max. 700 mA, NPN output: 0.2 ... 36 V DC, PNP output: operating voltage, frequency up to 300 Hz (Frequency [Hz] = K factor [pulse/litre] x flow rate [l/s])
Environment	
<b>Ambient temperature</b>	-15 ... +60 °C (operating and storage)
<b>Relative humidity</b>	≤ 80 %, without condensation
Standards, directives and certifications	
<b>Protection class</b>	IP67 with multipin M12 (IP65 with cable)
<b>Standard and directives CE</b>	The applied standards, which verify conformity with the EU Directives, can be found on the EU Type Examination Certificate and/or the EU Declaration of conformity (if applicable)
Pressure	Complying with article 4, §1 of 2014/68/EU directive*
<b>Certifications / Certificates on request</b>	Inspection certificate 3.1 (acc. to EN-ISO 10204); Test report 2.2 (acc. to EN-ISO 10204); Certification of Conformity for the surface Quality (DIN4762-DIN4768-ISO/4287/1); 3 points Flow calibration certificate

\* For the 2014/68/EU pressure directive, the device can only be used under following conditions (depending on max. pressure, pipe diameter and fluid).

Type of fluid	Conditions
<b>Fluid group 1, article 4, §1.c.i</b>	DN ≤ 25
<b>Fluid group 2, article 4, §1.c.i</b>	DN ≤ 32 or PN*DN ≤ 1000
<b>Fluid group 1, article 4, §1.c.ii</b>	DN ≤ 25 or PN*DN ≤ 2000
<b>Fluid group 2, article 4, §1.c.ii</b>	DN ≤ 200 or PN ≤ 10 or PN*DN ≤ 5000

## Pressure/temperature diagram

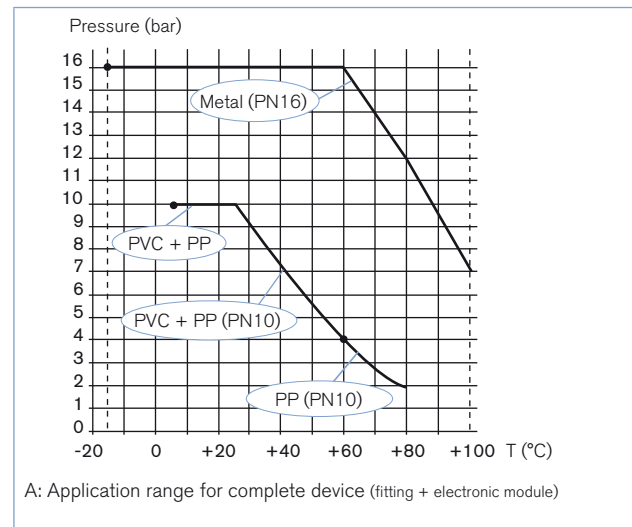

## Main features

### 8011 with magnetic principle Version with Transistor output

- ▶ Transistor output: NPN or NPN/PNP operation.
- ▶ With one transistor output
  - Raw frequency (2 pulses per paddle wheel rotation)

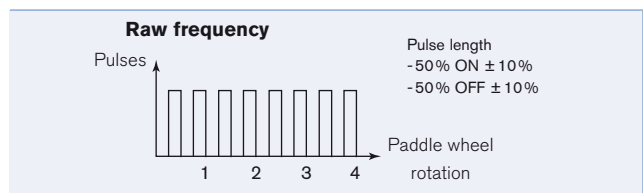

## Design and principle of operation

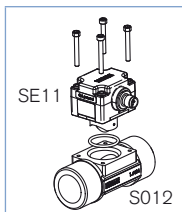

The flowmeter 8011 is built up with an electronic module and a measurement paddle wheel associated to a fitting. This connection is made by means of screws.

When liquid flows through the pipe, the paddle wheel is set in rotation. The non-wetted permanent magnets inserted in the paddle wheel generate a measuring signal which frequency is proportional to the flow velocity.

It is designed for connection to any system with open collector NPN or PNP frequency input.

The output signal is provided via a 5 pin M12 fixed connector (or a cable gland with 1 m-length cable on request).

Installation

Minimum straight inlet and outlet distances must be observed. According to the pipes design, necessary distances can be bigger or use a flow conditioner to obtain the best results. The most important layouts that could lead to turbulence in the flow are shown below, together with the associated prescribed minimum inlet and outlet distances determined according to the standard EN ISO 5167 - 1

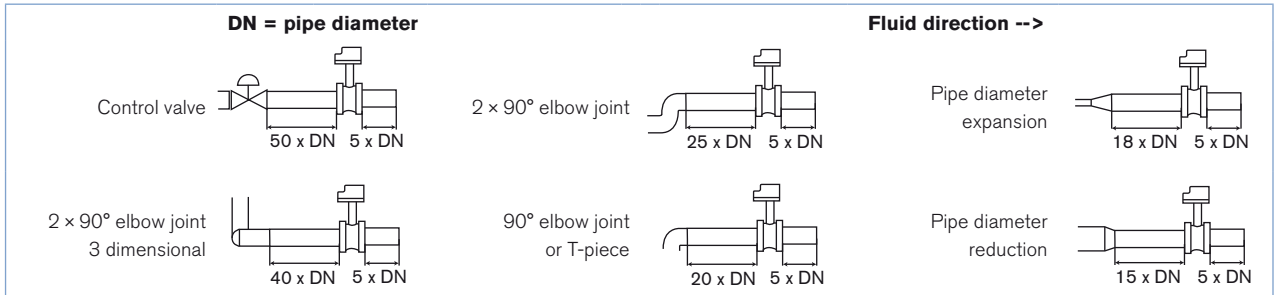

The flowmeter can be installed in either horizontal or vertical pipes, but following additional conditions should be respected

- always install the 8011 so that the paddle wheel axis is horizontal
- ensure the pipe is maintained full at all times, near the device
- ensure the pipe design does not allow the build-up of air bubbles or cavities within the medium, near the device

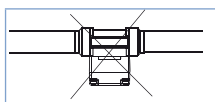
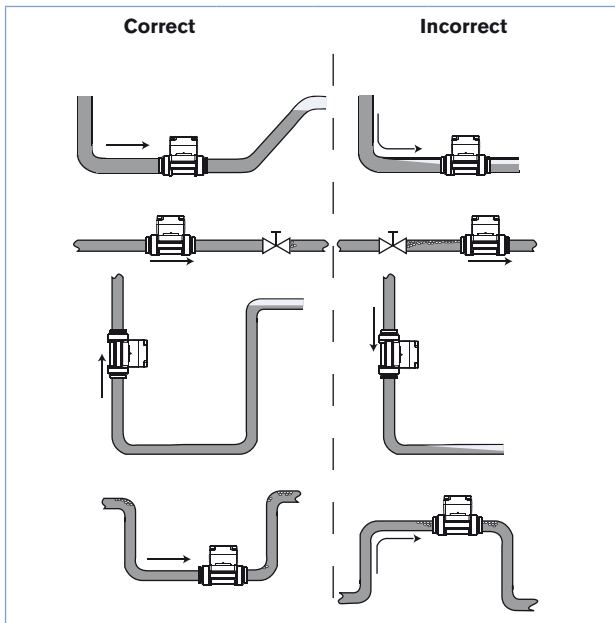

When installing the 8011 on an horizontal pipe, make sure the paddle wheel is oriented down.

Pressure and temperature ratings must be respected according to the selected fitting material. The suitable pipe size is selected using the diagram Flow/Velocity/DN. The measuring device is not designed for gas flow measurement.

Diagram Flow/Velocity/DN

Example:

- Flow: 10 m³/h
- Ideal flow velocity: 2... 3 m/s

For these specifications, the diagram indicates a pipe size of DN40 [or DN50 for (\*) mentioned fittings]

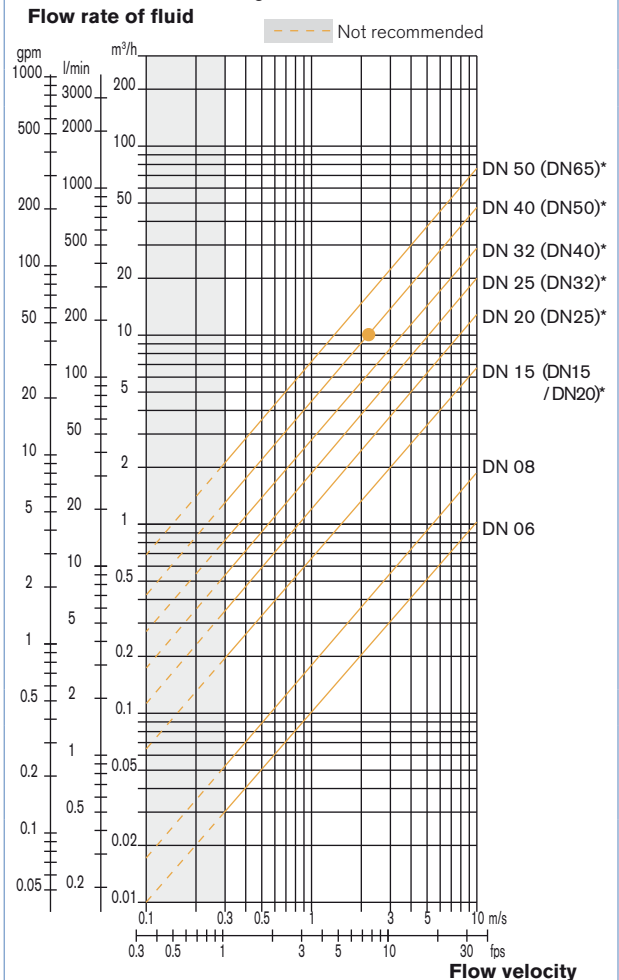

- \* for following fittings with:
- external threads acc. to SMS 1145
  - weld ends acc. to SMS 3008, BS4825-1/ASME BPE/DIN 11866 series C or DIN 11850 series 2/DIN 11866 series A/DIN EN 10357 series A
  - Clamp acc. to SMS 3017, BS 4825-3/ASME BPE or DIN 32676 series A

**Dimensions [mm] electronic module**

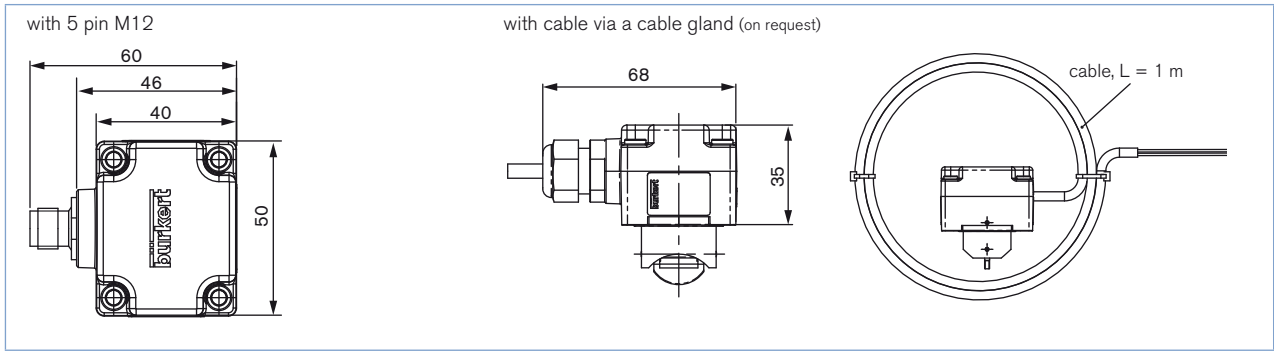

**Dimensions 8011**

**8011 with internal thread connection**

G, NPT or Rc  
in stainless steel (316L - 1.4404) or  
brass (CuZn39Pb2)

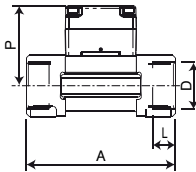

DN [mm]	P [mm]	A [mm]	D [inch]	L [mm]
15	57.5	84.0	G 1/2	16.0
			NPT 1/2	17.0
			Rc 1/2	15.0
20	55.0	94.0	G 3/4	17.0
			NPT 3/4	18.3
			Rc 3/4	16.3
25	55.2	104.0	G 1	23.5
			NPT 1	18.0
			Rc 1	18.0
32	58.8	119.0	G 1 1/4	23.5
			NPT 1 1/4	21.0
			Rc 1 1/4	21.0
40	62.6	129.0	G 1 1/2	23.5
			NPT 1 1/2	20.0
			Rc 1 1/2	19.0
50	68.7	148.5	G 2	27.5
			NPT 2	24.0
			Rc 2	24.0

**8011 with external thread connection**

G, NPT or Rc  
in stainless steel (316L - 1.4404),  
brass (CuZn39Pb2)  
or PVC

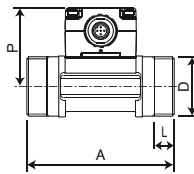

DN [mm]	P [mm]	A [mm]	D [inch]	[mm]	L [mm]
06	52.5	90.0	G 1/2	-	14.0
08	52.5	90.0	** 1/2	M 16 x 1.5	14.0

\*\* G, NPT, RC according to fitting version

**8011 with True union connection**

DIN 8063, ASTM D 1785/76 or JIS K in PVC

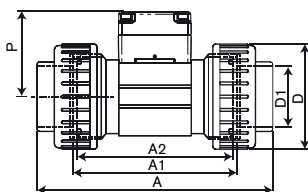

DN [mm]	P [mm]	D [mm]	A [mm]	ASTM	JIS	D1 [mm]	ASTM	JIS	A2 [mm]	A1 [mm]
15	57.5	43	128	130.0	129	20	21.3	18.40	90	96
20	55.0	53	144	145.6	145	25	26.7	26.45	100	106
25	55.2	60	160	161.4	161	32	33.4	32.55	110	116
32	58.8	74	168	170.0	169	40	42.2	38.60	110	116
40	62.6	83	188	190.2	190	50	48.3	48.70	120	127
50	68.7	103	212	213.6	213	63	60.3	60.80	130	136

## Ordering chart for 8011, 4.5 ... 24 V DC, 5 pin M12, NPN output

 Two versions of the fitting in DN15 and DN20 exist, having different K factors.

Only version 2, identified by the "v2" marking, is available from March 2012. The "v2" marking can be found:

- on the bottom of the DN15 or DN20 fitting in plastic:



- on the side of the DN15 or DN20 fitting in metal:



Process connection	Standard	Output	Article no.								
			DN06 - 1/4"	DN06 - 1/2"	DN08 - 1/2"	DN15	DN20	DN25	DN32	DN40	DN50
<b>Brass - Medium temperature max. 100 °C, PN16</b>											
Internal thread	G	Pulse NPN	-	-	-	559918	559919	559920	559921	559922	559923
	NPT	Pulse NPN	-	-	-	559924	559925	559926	559927	559928	559929
	Rc	Pulse NPN	-	-	-	559930	559931	559932	559933	559934	559935
External thread	G	Pulse NPN	559915	559916	559917	-	-	-	-	-	-
<b>Stainless steel - Medium temperature max. 100 °C, PN16</b>											
Internal thread	G	Pulse NPN	-	-	-	559939	559940	559941	559942	559943	559944
	NPT	Pulse NPN	-	-	-	559946	559947	559948	559949	559950	559951
	Rc	Pulse NPN	-	-	-	559952	559953	559954	559955	559956	559957
External thread	G	Pulse NPN	559936	559937	559938	-	-	-	-	-	-
	NPT	Pulse NPN	-	-	559945	-	-	-	-	-	-
<b>PVC - Medium temperature max. 60 °C, PN10</b>											
True union	DIN	Pulse NPN	-	-	-	559960	559961	559962	559963	559964	559965
	ASTM	Pulse NPN	-	-	-	559966	559967	559968	559969	559970	559971
	JIS	Pulse NPN	-	-	-	559972	559973	559974	559975	559976	559977
External thread	G	Pulse NPN	-	559958	559959	-	-	-	-	-	-

### Further versions on request



#### Port connection

Weld ends SMS 3008, BS 4825-1/ASME BPE/DIN 11866 series C or DIN 11850 series 2/DIN 11866 series A/ DIN EN 10357 series A  
 Clamp DIN 32676 series B, SMS 3017, BS 4825-3/ASME BPE or DIN 32676 series A  
 Flange EN1092-1/B1/PN16, ANSI B16-5 or JIS 10K  
 True union ISO 10931  
 Spigot ISO 10931



#### Materials

Fitting: PVC, PP,  
 Seal: EPDM  
 Special surface finish



#### Electrical connection

with 1 m cable



#### Additional

Two pulse NPN/PNP outputs

Please also use the "request for quotation" form on page 8 for ordering further versions of the 8011 [go to page](#)

## Ordering chart for accessories for 8011 (to be ordered separately)

Specification	Article no.							
	DN06	DN08	DN15	DN20	DN25	DN32	DN40	DN50
4 short screws (M4 x 35 - A4) + 4 long screws (M4 x 60 - A4)								
5 pin M12 female connector moulded on cable (2 m, shielded)								
5 pin M12 female connector with plastic threaded locking ring								
	555775							
	438680							
	917116							

Specification	Article no.							
	DN06	DN08	DN15	DN20	DN25	DN32	DN40	DN50
O-ring set for metal fitting - FKM	426340	426340	426340	426340	426340	426340	426340	426340
O-ring set for metal fitting - EPDM	426341	426341	426341	426341	426341	426341	426341	426341
O-ring set for plastic fitting - FKM	-	448679	431555	431556	431557	431558	431559	431560
O-ring set for plastic fitting - EPDM	-	448680	431561	431562	431563	431564	431565	431566

## Variants of flowmeter Type 8011

### A flowmeter Type 8011 consists of:

- an electronic module SE11 with magnetic measuring principle, with pulse output. The electrical connection is carried out through a 5 pin M12 fixed connector or a 1 m cable.
- a fitting Type S012 available in different materials providing many installation options of the electronic module into all pipes, ranging from DN06 to DN65, due to the large range of process connections (see specification sheet on last page).
- screws and O-ring (see ordering chart for accessories).

The following charts indicate the different variants:

### Electronic module Type SE11

Specification	Pipe connection	Operating voltage	Output*	Connection	Article no.
Magnetic measuring principle	DN06, DN08, DN15 v2 and DN20 v2	4.5 ... 24 V DC	Frequency with pulse NPN	5 pin M12 fixed connector with 1 m cable	559440
			Frequency with pulse PNP		559442
		6 ... 36 V DC	Frequency with pulse NPN/PNP	5 pin M12 fixed connector with 1 m cable	559441
			Frequency with pulse PNP/PNP		559443
	DN15...DN50 (except DN15 v2 and DN20 v2)	4.5 ... 24 V DC	Frequency with pulse NPN	5 pin M12 fixed connector with 1 m cable	559444
			Frequency with pulse PNP		559446
		6 ... 36 V DC	Frequency with pulse NPN/PNP	5 pin M12 fixed connector with 1 m cable	559445
			Frequency with pulse PNP/PNP		559447

### Fitting Type S012 (possibilities versions - ⚠ can not be ordered separately)

Port connection	Materials	Available									
		DN06	DN08	DN15	DN20	DN25	DN32	DN40	DN50	DN65	
Internal thread	Brass, stainless steel	-	-	Yes	Yes	Yes	Yes	Yes	Yes	Yes	-
External thread	Brass, stainless steel, PVC, PP	Yes	Yes	Yes	Yes	Yes	Yes	Yes	Yes	Yes	-
	Stainless steel acc. SMS 1145	-	-	-	-	Yes	-	Yes	Yes	Yes	-
Weld ends	Stainless steel	-	Yes	Yes	Yes	Yes	Yes	Yes	Yes	Yes	Yes
Clamp	Stainless steel	-	Yes	Yes	Yes	Yes	Yes	Yes	Yes	Yes	Yes
Flange	Stainless steel	-	-	Yes	Yes	Yes	Yes	Yes	Yes	Yes	-
True union	PVC	-	Yes	Yes	Yes	Yes	Yes	Yes	Yes	Yes	-
	PP	-	-	Yes	Yes	Yes	Yes	Yes	Yes	Yes	-
Spigot	PVC, PP	-	-	Yes	Yes	Yes	Yes	Yes	Yes	Yes	-

⚠ Fitting in PVDF not available.

Interconnection possibilities with the 8011

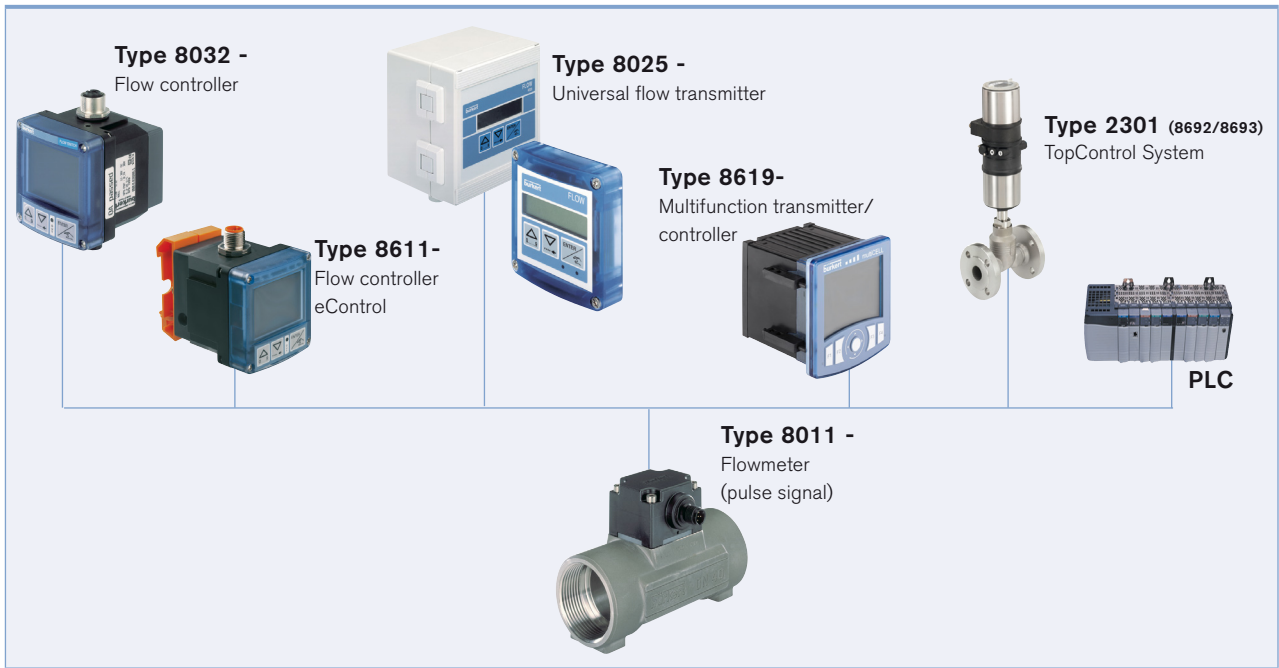

Fluid block system using Type 8011

The modular concept of the electronic module Type SE11 allows fully customized, pre-mounted and tested solutions to completely meet application needs. It is designed for being mounted in a system block, associated with other Bürkert products. This allows cost reduction and compact design for customized solutions.

Please contact your Bürkert local office to have individual counselling and engineering support in order to find the best solution corresponding to your application.

Example of flow control systems with SE11 electronic module

**Cooling of molding tools  
in plastic injection machines**

Flow (8011) + temperature +  
manual On/Off valve

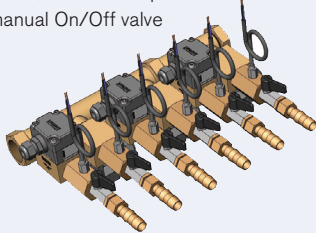

**Cooling of welding robot  
in automotive industry**

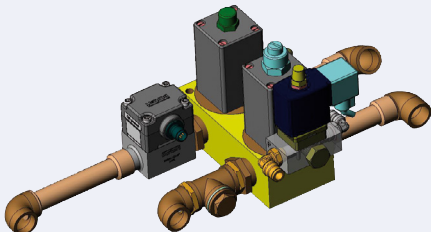

Flow (8011) +  
pilot valve (6014) +  
On/Off diaphragm valve (0263)

**On/Off control loop**

Valve island  
AirLine  
Type 8644

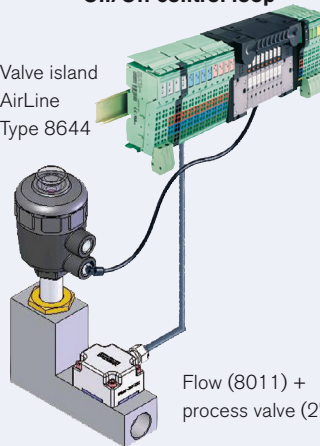

Flow (8011) +  
process valve (2712)

**Filter monitoring in  
waste water treatment**

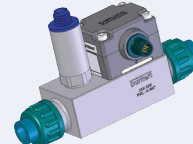

Flow (8011) +  
pressure (8316)

**Flow regulation  
in Ro water treatment skid**



Process valve  
(2712 + 8692)  
+ Flow (8011)

## Flowmeter 8011 - request for quotation

Please fill in and send to your local Bürkert Sales Centre with your inquiry or order.

## Note

You can fill out the fields directly in the PDF file before printing out the form.

Company:	Contact person:
Customer No.:	Department:
Address:	Tel. / Fax.:
Postcode / Town:	E-mail:

<b>Flowmeter 8011</b>	Quantity: <input type="text"/>	Desired delivery date: <input type="text"/>
<b>Fitting S012</b>		
<b>■ Pipe diameter DN</b> <input type="checkbox"/> 6 <input type="checkbox"/> 8 <input type="checkbox"/> 15 <input type="checkbox"/> 20 <input type="checkbox"/> 25 <input type="checkbox"/> 32 <input type="checkbox"/> 40 <input type="checkbox"/> 50 <input type="checkbox"/> 65		
<b>■ Materials:</b>		
<b>Body</b>	<input type="checkbox"/> Brass	<input type="checkbox"/> Stainless steel
	<input type="checkbox"/> PVC	<input type="checkbox"/> PP
<b>Seal</b>	<input type="checkbox"/> FKM	<input type="checkbox"/> EPDM
<b>■ Process connection:</b>		
<b>Internal thread</b>	<input type="checkbox"/> G	<input type="checkbox"/> NPT
<b>External thread</b>	<input type="checkbox"/> G	<input type="checkbox"/> NPT
<b>Weld ends</b>	<input type="checkbox"/> EN ISO1127/ISO4200/DIN 11866 series B	<input type="checkbox"/> SMS 3008
	<input type="checkbox"/> DIN 11850 series 2/DIN 11866 series A/DIN 10357 series A	<input type="checkbox"/> BS4825-1/ASME BPE/DIN 11866 series C
<b>Clamp</b>	<input type="checkbox"/> DIN 32676 series B	<input type="checkbox"/> SMS 3017
	<input type="checkbox"/> BS4825-3/ASME BPE	<input type="checkbox"/> DIN 32676 series A
<b>Flange</b>	<input type="checkbox"/> EN1092-1/B1/PN16	<input type="checkbox"/> ANSI B16-5
<b>True union</b>	<input type="checkbox"/> DIN 8063	<input type="checkbox"/> ASTM
	<input type="checkbox"/> DIN 16962	<input type="checkbox"/> JIS
<b>Spigot</b>	<input type="checkbox"/> DIN 8063	<input type="checkbox"/> JIS
	<input type="checkbox"/> DIN 16962	
<b>■ Special surface finish</b>	<input type="checkbox"/> without	<input type="checkbox"/> with Ra int. = <input type="text"/> Ra ext. = <input type="text"/>
<b>Electronic module SE11</b>		
<b>■ Electrical connection</b>	<input type="checkbox"/> Multipin M12	<input type="checkbox"/> with 1 m cable
<b>1. Transistor output feature</b>		
<b>■ Transistor operation*</b>	<input type="checkbox"/> NPN	<input type="checkbox"/> NPN/PNP

\* Refer to electrical features for operating voltage and current limits

To find your nearest Bürkert facility, click on the orange box →

[www.burkert.com](http://www.burkert.com)

In case of special application conditions, please consult for advice.

Subject to alteration.  
© Christian Bürkert GmbH & Co. KG

1803/17\_EU-en\_00891979