

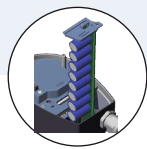

Type 3361 can be combined with...



**Touch Display**



**SAFEPOS**  
energy-pack



**Type 3360**  
for highest control  
accuracy



**Fieldbus**



The innovative process controller Burkert valve Type 3361 is the solution when it comes to demanding control tasks and operating conditions. The electromotive actuator with ball screw positions the control cone with highest precision. A unique feature is its high positioning speed of 6 mm/s, that reacts quasi delay-free to process signals, and can be varied according to customer demands. Pressure variations or shocks in the medium aren't transferred to the valve position. Each flow optimized valve housing can be equipped with up to 5 different valve seats for a precise adaptation according to customer needs. If necessary, the safety position can be approached by an optional energy storage in case of power failure. Actuator and valve are adapted perfectly to each other with closed design and robust surface. This ensures the hygienic requirements of a fast and residue-free cleaning. Harsh environment are no problem for the Type 3361 because of the protection class IP65 / IP67 and its high impact and vibration resistance. Unrivalled cycle life and sealing integrity is guaranteed by the proven self adjusting spindle packing with exchangeable V-seals. The fieldbus suitable Type 3361 provides many helpful functions for process monitoring, valve diagnostics and predictive maintenance and thus offers the decisive advantage of a modern process automation.

- high precise and fast flow control
- several  $K_{vs}$  value per port size due to removable trim kit
- weather, impact and vibration resistant design
- easy cleaning by its design according hygienic demands
- position controller und process controller available

Technical data	
<b><math>K_{vs}</math> values</b>	0.4 ... 37 m <sup>3</sup> /h
<b>Port and seat size</b>	DN10 ... DN50 / DN3 ... DN50
<b>Operating pressure</b>	16 bar / 1600 kPa / 232 psi
<b>Port connections</b>	Flange Thread Weld ends Clamp
<b>Medium</b>	Neutral Gas, water, alcohol, oil, fuels, hydraulic mediums, salt solution, alkali solutions, organic solvents, steam
<b>Viscosity</b>	max. 600 mm <sup>2</sup> /s
<b>Media temperature</b>	- 10...+185 °C (seat sealing steel/steel) - 10...+185 °C (seat sealing PEEK/steel) - 10...+130 °C (seat sealing PTFE/steel)
<b>Ambient temperature</b>	-25...+65 °C (without touch display) -25...+60 °C (with touch display) -25...+55 °C (with SAFEPOS energy storage) Note: Derating see temperature chart
<b>Seat leakage according to IEC 534-4/EN 1349</b>	Shut-off class III and IV for steel/steel Shut-off class VI for PTFE/steel and PEEK/steel
<b>Safety position at power failure</b>	with SAFEPOS energy-pack: opened, closed or free programmable without SAFEPOS energy-pack: blocked in last position
<b>Power supply</b>	24 V DC ± 10 % (max. residual ripple 10 %)
<b>Closing time (100% stroke)</b>	3.3 ... 4.5 sec. (depending on stroke)
<b>Travel speed</b>	6 mm/s
<b>Deadband (min.)</b>	0.1 %
<b>Duty cycle</b>	100 %
<b>Protection class</b>	IP65 / IP67
<b>Controller type</b>	Position controller or process controller
<b>Analogue control</b>	Setpoint: 0–20 mA, 4–20 mA, 0–5 V, 0–10 V actual value optional

## Technical data, continued

---

<b>Digital control (fieldbus)</b>	EtherNet/IP, Modbus/TCP, PROFINET (optional)
<b>Vibration, sinusoidal</b>	5 g according to IEC 60068-2-6 Test Fc
<b>Shock, mechanical</b>	50 g according to IEC 60068-2-27 Test Ea
<b>Approval and Conformity</b>	EGV 1935/2004 (standard) FDA (optional) ATEX II Cat 3G/D / IECEx (optional) cULus Cert. No. 238179 (optional)
<b>Ignition protection</b>	II 3G Ex ec IIC T4 Gc II 3D Ex tc IIIC T135 °C Dc

---

## Structure and function

The electromotive linear actuator consists of a brushless direct current motor, gears and a threaded spindle. The valve spindle, which is connected to the threaded spindle, transfers the force to the control cone. The electronic control system is actuated either via standard signals (analog) or via a field bus (digital). Optionally there is the energy pack (SAFEPOS energy-pack) for the device. If the supply voltage fails, the energy pack supplies the actuator with the required energy to move the valves into the required position which can be adjusted via a menu.

The valve position can be manually changed in 2 ways. Either over an electrical manual control or over mechanical manual control, if no supply voltage applied. The device can be set and operated either via 2 capacitive buttons and 4 DIP switches or optionally on a display with touch-screen. There is also the option of setting the device via the bus Service interface and by using the PC software "Bürkert-Communicator".

The intelligent process valve Type 3361 offers the operator options for process monitoring, valve diagnostics and predictive maintenance. Internal measurements for the operating state are evaluated and, if issued as a warning or error message. This signal, for example, undue environmental and process conditions, functional deviations of components or the state of the energy accumulator. Internal measurements for operating state are evaluated and, possible a warning or error message is issued. This signal indicates, for example, bad environmental and process conditions, functional deviations of components or the state of the energy accumulator. A special feature of the globe control valve is the screwed valve seat which can be replaced to reduce the nominal diameter.

### Structure, electromotive globe seat control valve Type 3361

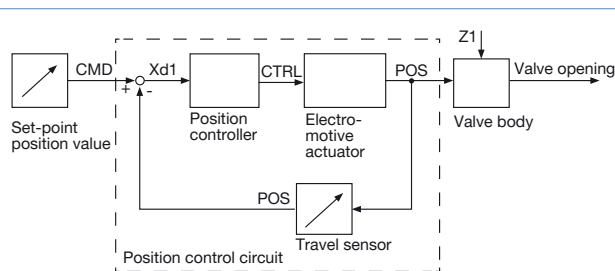
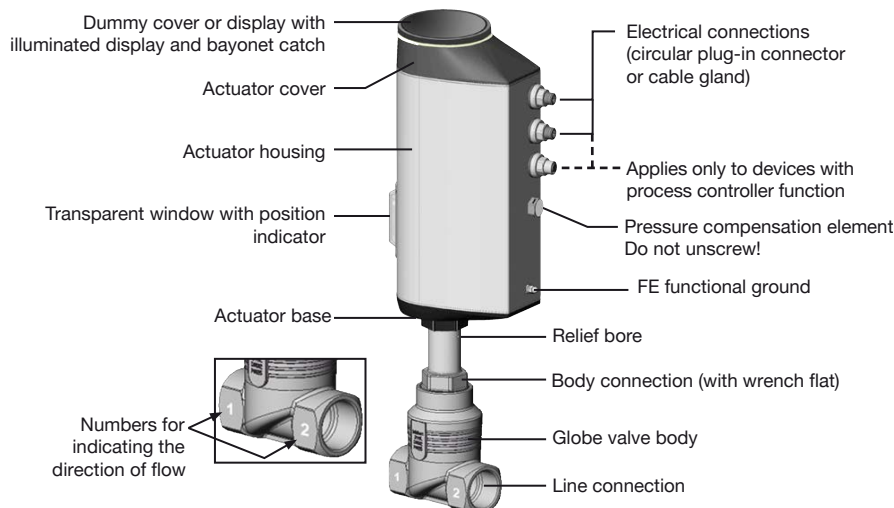

#### Integrated position controller

The position of the actuator (stroke) is regulated according to the set-point position value. The set-point position value is specified either by an external standard signal (analog) or via a field bus (digital). The travel sensor records the actual position (POS) of the electric linear actuator. The position controller compares this actual position value with the set-point position value (CMD) which is defined as standard signal. If there is a control difference ( $X_d^1$ ), the electromotive actuator is controlled via the CTRL variable and the actual position value is changed accordingly.

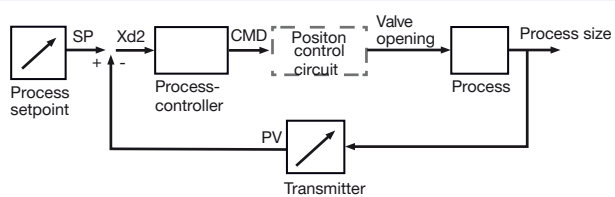

#### Integrated process controller

By implementing a PID controller can a process control be carried out. From the external signal (z.B. level, pressure, flow, temperature) the process setpoint and the actual process value is calculated on the control parameters (PID controller) for the target position of the valve.

## Structure and function, continued

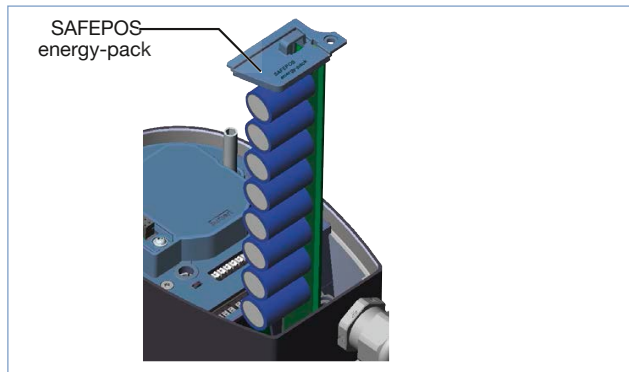

### Safety position with energy storage (Option)

The safety starting positions in case of power interruption is realized with the optional energy storage SAFEPoS energy-pack. The desired position is adjusted from the menu. Here any intermediate position can be defined in addition to the end positions (NO / NC). The energy storage has a lifespan of up to 10 years, depending on the operating conditions. The power of the energy storage is monitored and a warning is displayed to indicate its life is coming to an end. The memory is designed as a plug-in module making it easy to exchange. Without energy storage, the valve remains in the last position. The energy storage is fully charged after maximum 100 sec.ds (depending on the operating conditions) and ready to use.

## Controls and indicators

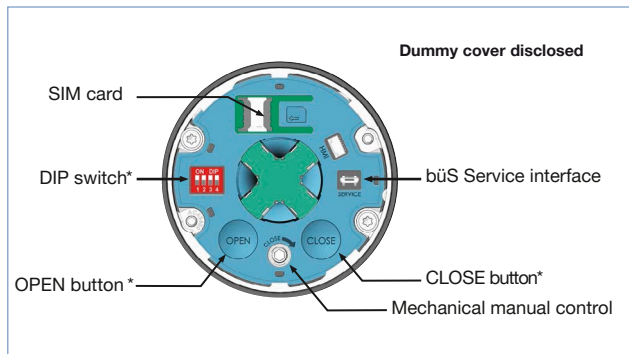

### Devices without display module

In the version without control display the basic functions are operated by 4 DIP switches and 2 pushbuttons. These are located under the dummy cover which can be removed manual by turning. Through the bÜS service access, the device can also be configured in detail with the Bürkert communicator software. For this, the optional USB-bÜS interface kit is required.

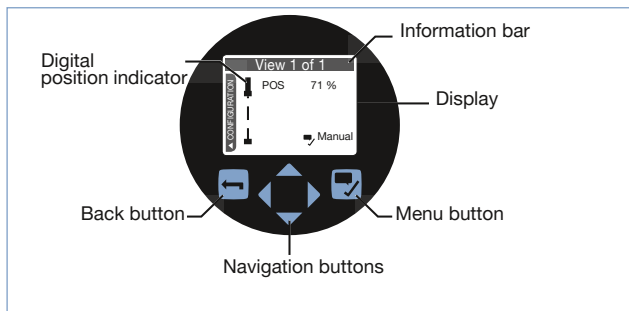

### Robust display with control buttons (optional)

The robust display module is easy to use, it configures and displays all the required functions. In addition to the start screen you can also switch to the configuration view and user-specified views as needed. All functions of the device without display module like bÜS-Service interface are available too.

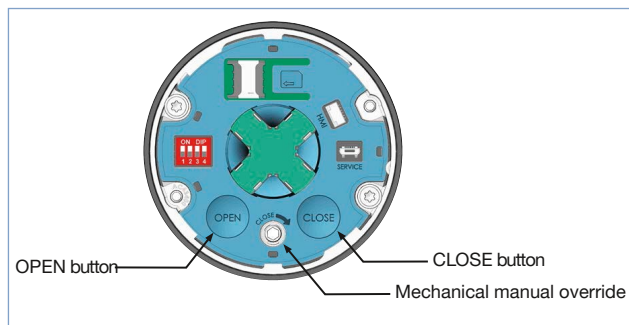

### Manual and electrical operation

The manual override for mechanical operation of the valve is located under the dummy cover or the display module. Electrical manual override for the procedure is carried out directly on the touch screen, or in the version without a display by two buttons below the dummy cover.

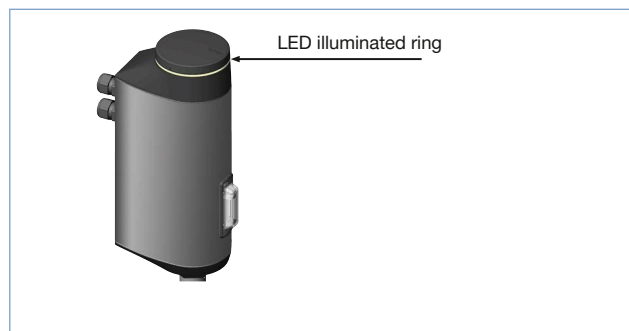

### 360° - LED Illuminated ring

To display the device status, the valve timing and the operating condition a visible 360° LED illuminated ring is mounted around the dummy cover or the display module. The LED ring lights up, flashes or flashes in one or different colors. Depending on customer requirements 4 different LED modes can be selected (Namur mode, valve mode with warnings, valve mode without warnings, LED off)

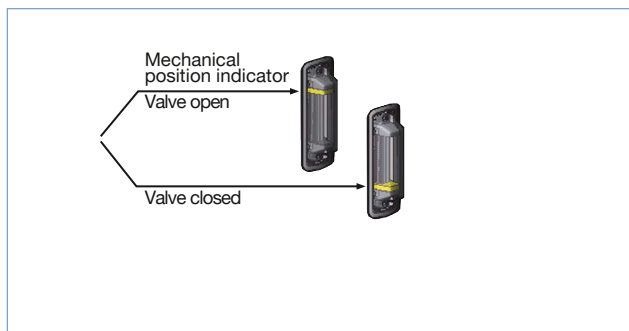

### Mechanical position indicator

The mechanical position indicator also indicates when the supply voltage of the current valve position fails

## Controls and indicators, continued

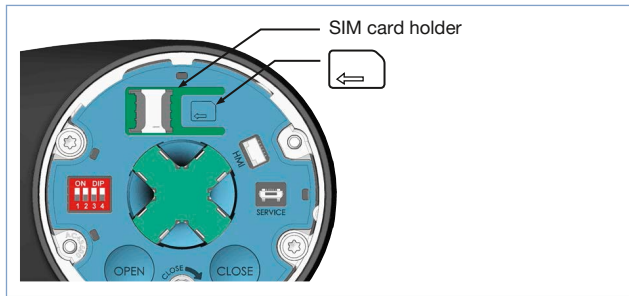

### SIM card as data storage (option)

With the SIM card optional device-specific values and user settings can be saved and quickly transferred to another device.

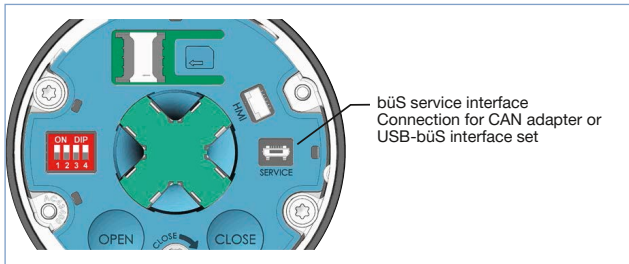

### bUS service interface

The bUS service interface connects the device to the communicator software on a PC, laptop or smartphone. From there, a configuration of the device or failure diagnosis can be performed.

Design and materials view

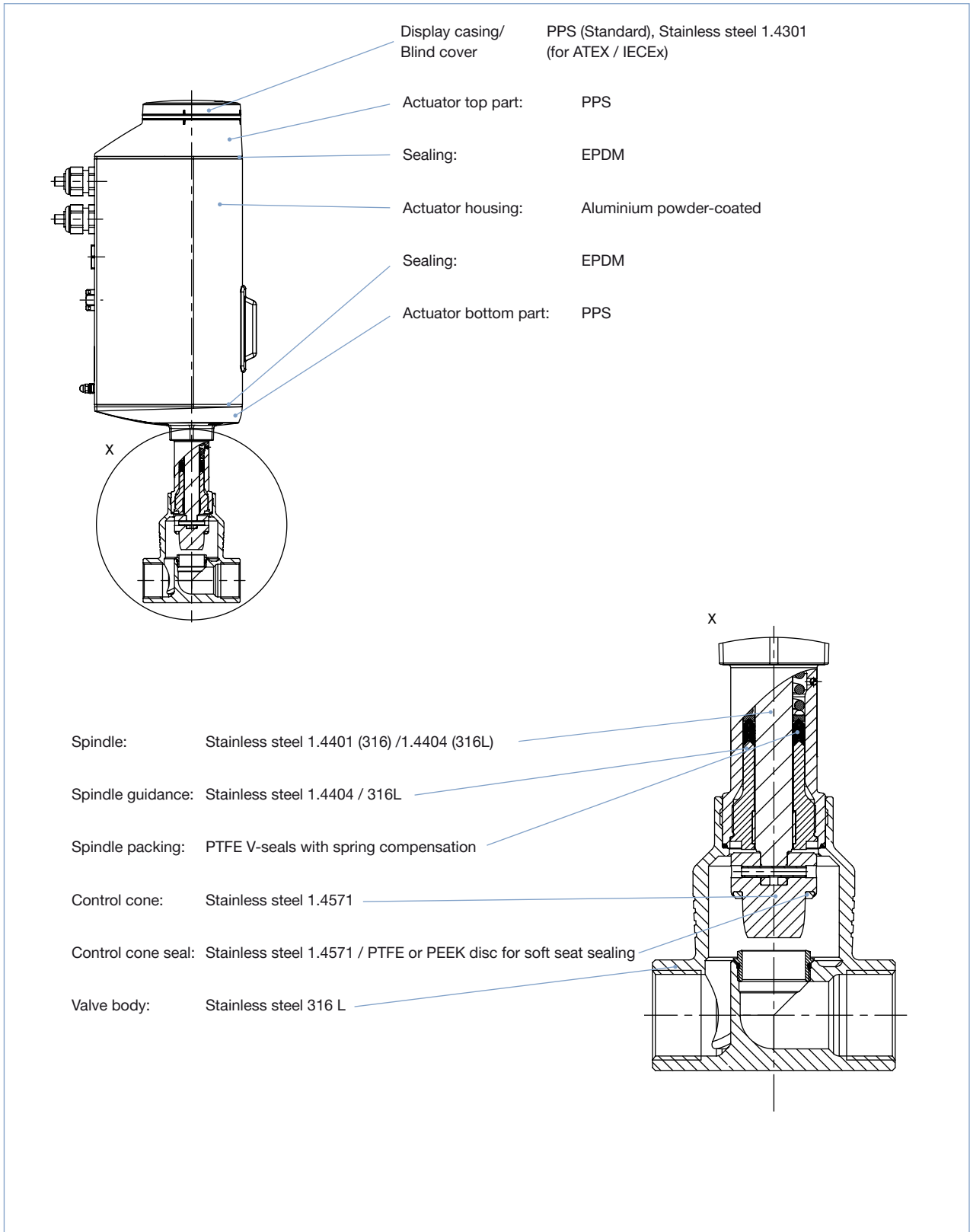

Note: The globe control valve **Type 3361** could be delivered with miscellaneous port connection (thread, weld ends and clamp), there are not be represented in the picture, but are made with same material as the valve body.

## Technical data

### Temperature chart

The maximum allowable ambient temperature and media temperature influence each other. The maximum allowable temperature curves of different device variants can be seen in the temperature chart. The curves were determined for maximum operating conditions (max. operating pressure and motor power). For deviating operating conditions an individual verification can be performed. Please contact your Bürkert office for more information.

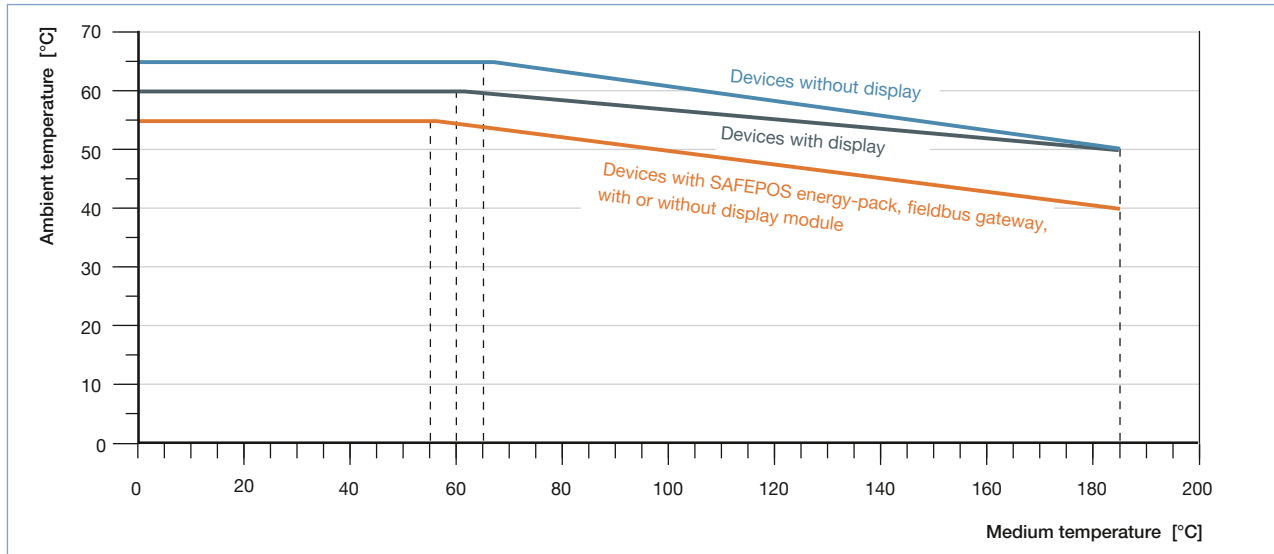

### Flow characteristic

The straight seat control valve shows different characteristics depending on the orifice.

- Equal percentage of parabolic cone for valve seats with orifice DN8...DN50
- Linear cone for valve seats of the orifice DN4 and DN6, flow characteristic according to DIN / IEC 534-2-4
- Theoretical setting ratio (KvS: Kv<sup>9)</sup>
  - Orifice DN8...DN50: 50: 1
  - Orifice DN6: 25: 1
  - Orifice DN4: 10: 1
- KvR value<sup>9)</sup> at 5 % of the stroke for DN > 10 mm  
KvR value at 10 % of the stroke for DN ≤ 10 mm

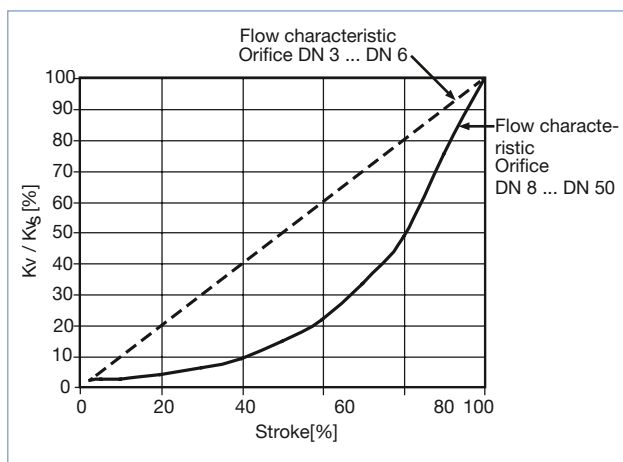

<sup>9)</sup> KvR value= the smallest K<sub>v</sub> value at which the angularity tolerance according to DIN / IEC 534-2-4 can still be maintained.

### Selection chart for seat sealing

Seat sealing type steel / steel is recommended for shut-off class III and IV.

Seat sealing with PTFE is used for shut-off class VI, if fluid temperature is < 130 °C. If the maximum fluid temperature exceeds 130 °C temporarily or permanently, then PEEK is used for seat sealing.

Shut-off class VI	PEEK / steel (T Media max. > 130 °C)	Operation pressure 0 ... 10 bar
	PTFE / steel	
Shut-off class III or IV	STEEL / steel	Operation pressure 0 ... 16 bar
	Fluid temperature -10 °C ... 130 °C	



## Technical data, continued

## Flow below seat

Port connection (tube)		Seat size		Operating pressure seal / conical seat			Leakage class seal / conical seat		K <sub>v</sub> value with stroke [m <sup>3</sup> /h]						K <sub>vs</sub> value
									5 %	10 %	30 %	50 %	70 %	90 %	
[mm]	[inch]	[mm]	[inch]	stainless steel / stainless steel [bar]	PTFE / stainless steel [bar]	PEEK / stainless steel [bar]	stainless steel / stainless steel	PTFE o. PEEK / stainless steel							
10	3/8	3	0.12	16	-	-	IV	-	0.001	0.003	0.015	0.037	0.065	0.090	0.1
		4 <sup>1)</sup>	0.16						0.005	0.015	0.100	0.190	0.265	0.325	0.35
		4	0.16						0.04	0.05	0.16	0.27	0.36	0.44	0.5
		6 <sup>2)</sup>	0.24						0.05	0.12	0.48	0.76	0.98	1.13	1.2
		6 <sup>3)</sup>	0.24						0.005	0.007	0.045	0.16	0.41	1.08	1.25
		8	0.31						0.06	0.07	0.12	0.26	0.61	1.50	2.0
		10	0.39						0.09	0.11	0.19	0.48	1.00	2.30	2.7
15	1/2	3	0.12	16	-	-	IV	-	0.001	0.003	0.015	0.037	0.065	0.090	0.1
		4 <sup>1)</sup>	0.16						0.005	0.015	0.100	0.190	0.265	0.325	0.35
		4	0.16						0.04	0.05	0.16	0.27	0.36	0.44	0.5
		6 <sup>2)</sup>	0.24						0.05	0.12	0.48	0.76	0.98	1.13	1.1
		6 <sup>3)</sup>	0.24						0.005	0.007	0.045	0.160	0.410	1.080	1.25
		8	0.31						0.07	0.08	0.13	0.27	0.63	1.60	2.1
		10	0.39						0.09	0.11	0.19	0.49	1.10	2.50	3.1
20	3/4	15	0.59	16	-	-	IV	-	0.14	0.17	0.35	0.80	1.80	3.70	4.3
		10	0.39						0.11	0.12	0.20	0.52	1.20	2.60	3.2
		15	0.29						0.14	0.17	0.35	0.80	1.80	4.00	5.2
25	1	20	0.79	16	16	10	IV	VI	0.20	0.25	0.45	1.10	2.40	5.20	7.1
		15	0.29	16	-	-	IV	-	0.14	0.17	0.35	0.80	1.80	4.10	5.3
		20	0.79	16	16	10	IV	VI	0.2	0.25	0.47	1.10	2.50	5.40	7.2
32	1 1/4	25	0.98	16	16	10	IV	VI	0.35	0.38	1.00	2.20	5.10	9.40	12.0
		20	0.79						0.22	0.25	0.50	1.10	2.50	5.80	8.0
		25	0.98						0.40	0.47	1.10	2.50	5.40	10.3	13.0
40	1 1/2	32	1.3	16	16	10	IV	VI	0.48	0.60	1.30	3.10	6.80	14.0	17.8
		20	0.79						0.40	0.47	1.10	2.50	5.40	10.3	13.0
		32	1.3						0.48	0.60	1.30	3.10	6.80	14.0	17.8
50	2	40	1.6	10	10	6	III	VI	0.60	0.70	1.70	4.00	9.20	18.2	23.8
		25	0.98	16	16	10	IV	VI	0.48	0.60	1.30	3.20	6.90	15.0	20.2
		40	1.6	10	10	6	III	VI	0.60	0.70	1.70	4.00	9.20	18.9	24.6
50	2	50	2.0	6	6	-	III	VI / -	0.90	1.10	2.90	6.80	15.5	29.3	37.0
		40	1.6	10	10	6	III	VI	0.60	0.70	1.70	4.00	9.20	18.9	24.6

<sup>1)</sup> low flow<sup>2)</sup> linear<sup>3)</sup> equal percentage

## Electrical control

Electrical data	
Protection class	3 acc. to DIN EN 61140
Electrical connections	Cable gland, 2 x M20 or 2 circular plug-in connector M12, 5 pin and 8 pin, 1 circular plug-in connector M12, 5 pin (only by process controller)
Operating voltage	24 V DC $\pm$ 10 % max. residual ripple 10 %
Operating current [A]*	max. 3 A including actuator at max. load and charging current of the optional SAFEPOS energy-pack (charging current approx. 1 A)
Lifelong energy storage SAFEPOS energy-pack	up to 10 years (depending on operating conditions)
Electronic without actuator [W]*	min. 2 W, max. 5 W
Control	
Input analogue:	galvanically isolated from the supply voltage and analog output 0/4...20 mA (input resistance 60 $\Omega$ ) 0...5/10 V (input resistance 22 k $\Omega$ )
Analogue actual value input 4...20 mA	Input resistance: 60 $\Omega$ Resolution: 12 bits
Frequency	Measurement range: 0...6500 Hz Input resistance: > 30 k $\Omega$ Resolution: 1 % of measurement value Input signal: > 300 mVss Waveform: Sine wave, rectangle wave, triangle wave
Pt 100	Measurement range: -20 to +220 $^{\circ}$ C Resolution: < 0.1 $^{\circ}$ C Measurement current: 1 mA
Output analogue:	Max. current 10 mA (for voltage output 0...5/10 V) Bürde (Last) 0...560 $\Omega$ (for current output 0/4...20 mA)
Output digital:	current limit 100 mA
Input digital:	0...5 V = log "0", 10...30 V = log "1" inverted input reversed accordingly
Communication interface:	Connection to PC via USB b $\ddot{u}$ S interface set
Communication Software:	Bürkert communicator

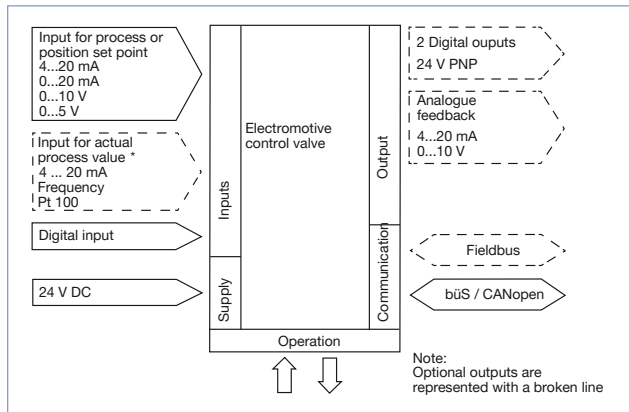

## Electrical control and interface

The position of the actuator is regulated according to the set-point position value. The set-point position value is specified either by an external standard signal (analogue) or via a field bus (digital).

## Analogue Control

For analogue control 2 variants are available for the inputs and outputs and the connection interface

## Input and output:

- \* 1 analogue input, 1 binary input
- \* 1 analogue input, 1 binary input, 1 analogue output, 2 binary output (option)
- 1 input for process actual value (for process controller version)

## Interface:

- \* cable gland with connection terminal
- \* M12 circular connectors M12 (option)



## Fieldbus: EtherNet/IP, PROFINET, Modbus TCP (option)

The Fieldbus Gateway for EtherNet / IP, PROFINET and Modbus TCP is integrated into a special module. It has 2 fieldbus connections with 4 pin M12 circular connectors. Under the gateway housing cover are the interfaces for the fieldbus connection and status LEDs. If there is a need to be include it in a network then the configuration of the Ethernet can be performed via the web server.

Dimensions [mm] - valve Type 3361 and valve system

Version with blind cover

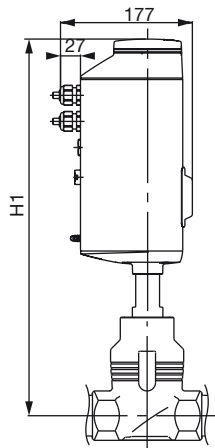

Version with Display

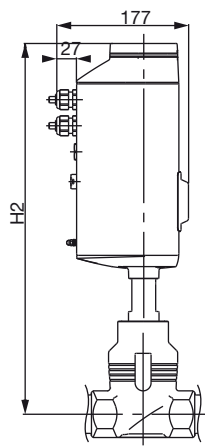

Version with CompactConnect and blind cover

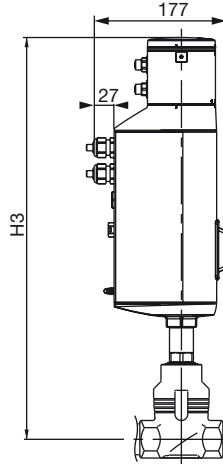

Version with CompactConnect and display

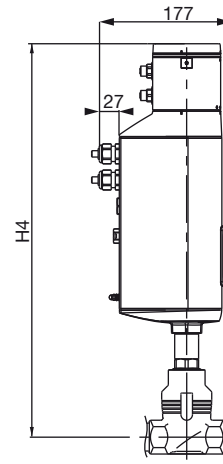

Port size [mm]	Height [mm]			
	H1	H2	H3	H4
10	417	417	489	489
15	417	417	489	489
20	423	423	496	496
25	446	446	518	518
32	474	474	546	546
40	479	479	551	551
50	485	485	557	557

Side view

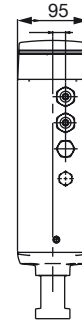

## Dimensions [mm] - valve body of Type 3361

## Flange connection

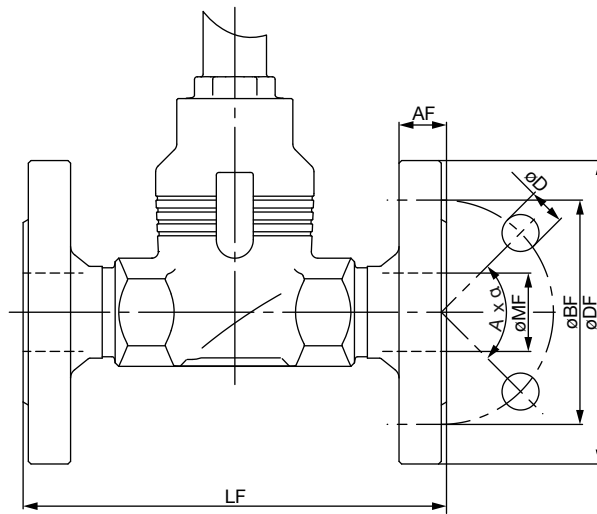

## DIN EN 1092, JIS 10K

Port size (tube) [mm]	DIN EN 1092 FTF series 1 acc. to DIN EN 558-1						JIS 10K FTF series 10 acc. to DIN EN 558-2					
	Ø DF	LF	Ø BF	AF	Ø D	Ø MF	Ø DF	LF	Ø BF	AF	Ø D	Ø MF
10	90	130	60	16	14	13.6	-	-	-	-	-	-
15	95	130	65	16	14	18.1	95	108	70	12	15	18.1
20	105	150	75	18	14	23.7	100	117	75	14	15	23.7
25	115	160	85	18	14	29.7	125	127	90	14	19	29.7
32	140	180	100	18	18	38.4	135	140	100	16	19	38.4
40	150	200	110	18	18	44.3	140	165	105	16	19	44.3
50	165	230	125	20	18	56.3	155	203	120	16	19	56.3

## ANSI B 16.5

Port size (tube) [inch]	ANSI B 16.5 Class 150 FTF series 37 acc. to DIN EN 558-2					
	Ø DF	LF	Ø BF	AF	Ø D	Ø MF
½	89	184	60.5	11.2	15.7	15.7
¾	99	184	69.9	12.7	15.7	20.8
1	108	184	79.2	14.2	15.7	26.7
1½	127	222	98.6	17.5	15.7	40.9
2	152	254	120.7	19.1	19.1	52.6

## Dimensions [mm] - valve body of Type 3361

### Threaded connection

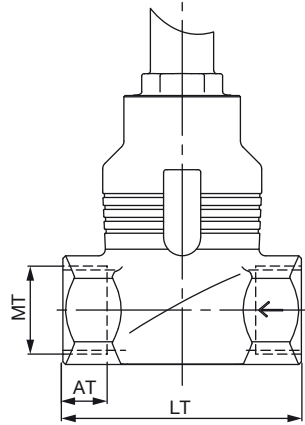

### G, RC, NPT (EN ISO 228-1, ISO 7/1 /DIN EN 10226-2, ASME B 1.20.1)

Port size (tube) [mm]	MT G / NPT / RC [inch]	LT	AT		
			G	NPT	Rc
10	3/8	65	12	10.3	10.1
15	1/2	65	14	13.7	13.2
20	3/4	75	16	14	14.5
25	1	90	18	16.8	16.8
32	1 1/4	110	20	17.3	19.1
40	1 1/2	120	22	17.3	19.1
50	2	150	24	17.6	23.4

## Dimensions [mm] - valve body of Type 3361

Weld end connection

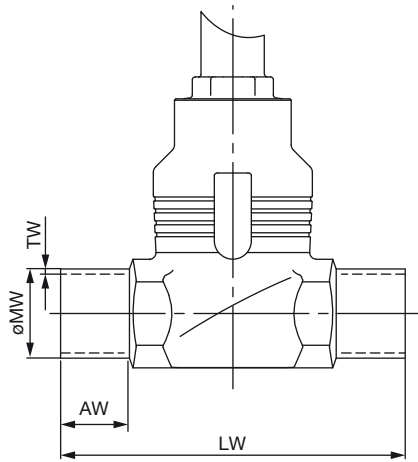

EN ISO 1127 series 1/ISO 4200/DIN 11866 series B, DIN 11850 series 2/DIN 11866 series A/DIN EN 10357 series A

Port size (tube) [mm]	AW	LW	EN ISO 1127 series 1/ ISO 4200/DIN 11866 series B		DIN 11850 series 2/DIN 11866 series A/DIN EN 10357 series A	
			Ø MW	TW	Ø MW	TW
10	20	90	17.2	1.6	13	1.5
15	20	90	21.3	1.6	19	1.5
20	20	100	26.9	1.6	23	1.5
25	26	130	33.7	2.0	29	1.5
32	26	140	42.4	2.0	35	1.5
40	26	150	48.3	2.0	41	1.5
50	26	175	60.3	2.0	53	1.5

BS4825 Part 1, ASME BPE/DIN 11866 series C

Port size (tube) [inch]	AW	LW	BS 4825 Part 1		ASME BPE/ DIN 11866 series C	
			Ø MW	TW	Ø MW	TW
½	20	90	12.7	1.2	12.7	1.65
¾	20	90	19.05	1.2	19.05	1.65
1	20	100	25.4	1.6	25.4	1.65
1½	26	140	38.1	1.6	38.1	1.65
2	26	150	50.8	1.6	50.8	1.65

## Dimensions [mm] - valve body of Type 3361

## Clamp connection

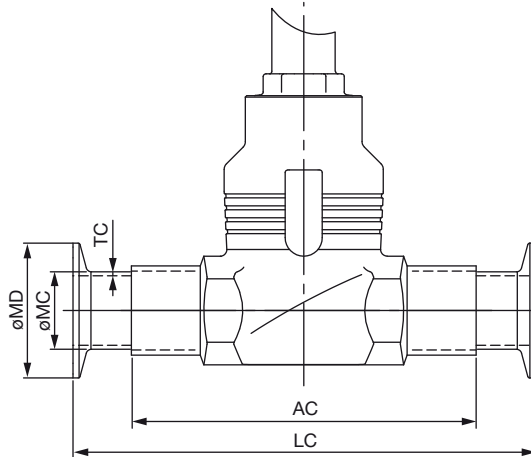













## DIN 32676 series A, ASME BPE/DIN 32676 series C oder BS4825-3

Port size (tube) [mm]	AC	LC	Clamp: DIN 32676 series A, Tube: DIN 11850 series 2/ DIN 11866 series A/ DIN EN 10357 series A			Clamp: ASME BPE/ DIN 32676 series C, Tube: ASME BPE/DIN 11866 series C			Clamp: BS4825-3, Tube: BS4825-1		
			Ø MC	Ø MD	TC	Ø MC	Ø MD	TC	Ø MC	Ø MD	TC
15	90	126	19	34.0	1.5	12.7	25.0	1.65	12.7	25.0	1.2
20	100	136	23	34.0	1.5	19.05	25.0	1.65	19.05	25.0	1.2
25	10	173	29	50.5	1.5	25.4	50.5	1.65	25.4	50.5	1.65
32	140	179	35	50.5	1.5	-	-	-	-	-	-
40	150	193	41	50.5	1.5	38.1	50.5	1.65	38.1	50.5	1.65
50	175	218	53	64.0	1.5	50.8	64.0	1.65	50.8	64.0	1.65

## DIN 32676 series B

Port size (tube) [mm]	AC	LC	Clamp: DIN 32676 series B, Tube: EN ISO 1127 series 1/ ISO 4200/DIN 11866 series B		
			Ø MC	Ø MD	TC
15	90	146	21.3	50.5	1.6
20	100	136	26.9	50.5	1.6
25	130	164	33.7	50.5	2.0
32	140	178	-	-	-
40	150	193	48.3	64.0	2.0
50	175	218	60.3	77.5	2.0

## Ordering chart for accessories

Accessory	Article no.
<b>Connection cable:</b>	
Connection cable with M12 socket, 4 pin, (length 5 m) for operating voltage	918038 
Connection cable with M12 socket, 8 pin, (length 2 m) for input and output signals	919061 
Connecting cable with M12 plug, 5 pin, (length 2 m) for input signals of process value (only for version with process controller)	559177 
<b>USB-büS interface set:</b>	
büS stick set 1 (including power supply unit, bus-stick, terminating resistor, Y-distributor, 0.7 m cable with M12 connector)	772426 
büS stick set 2 (including bus-stick, terminating resistor, Y-distributor, 0.7 m cable with M12 connector)	772551 
büS adapter for büS interface set (M12 on büS service interface Micro-USB)	773254 
<b>büS cable extensions from M12 plug to M12 socket:</b>	
Connecting cable, length 1 m	772404 
Connecting cable, length 3 m	772405 
Connecting cable, length 5 m	772406 
Connecting cable, length 10 m	772407 
<b>Miscellaneous</b>	
Bürkert Communicator	Infos at <a href="http://www.burkert.com">www.burkert.com</a>
SIM card	291773 
Holding device for line connection DN15 to DN20	693770 
Holding device for line connection DN25 to DN50	693771 



## Valve system – request for quotation

## Note

You can fill out the fields directly in the PDF file before printing out the form.

▶ Please fill out and send to your nearest Bürkert office\* with your inquiry or order

Company:	Contact person:
Customer no.:	Department:
Address:	Tel./Fax.:
Postcode/town:	E-Mail:

= mandatory fields to fill out

Quantity:

Required delivery date:

## Operating data

Pipe line	DN <input type="text"/>	PN <input type="text"/>		
Pipe Material	<input type="text"/>			
<input type="checkbox"/> Process medium	<input type="text"/>			
<input type="checkbox"/> Type of medium	<input type="checkbox"/> Liquid	<input type="checkbox"/> Steam <input type="checkbox"/> Gas		
	min.	standard	max.	Unit
<input type="checkbox"/> Flow rate (Q, Q <sub>N</sub> , W) <sup>1)</sup>	<input type="text"/>	<input type="text"/>	<input type="text"/>	<input type="text"/>
<input type="checkbox"/> Temperature at valve inlet T1	<input type="text"/>	<input type="text"/>	<input type="text"/>	<input type="text"/>
<input type="checkbox"/> Absolute pressure at valve inlet P1	<input type="text"/>	<input type="text"/>	<input type="text"/>	<input type="text"/>
<input type="checkbox"/> Absolute pressure at valve outlet P2	<input type="text"/>	<input type="text"/>	<input type="text"/>	<input type="text"/>
Steam Pressure P <sub>v</sub>	<input type="text"/>	<input type="text"/>	<input type="text"/>	<input type="text"/>
Kinematic viscosity (ν)	<input type="text"/>	mm <sup>2</sup> /s or cSt		
Dynamic viscosity (η)	<input type="text"/>	mPa.s or cP		
Standard density	<input type="text"/>	Kg/m <sup>3</sup>		
Max. sound level accepted	<input type="text"/>	dB (A)		

<sup>1)</sup> standard unit:  
Liquid Q = m<sup>3</sup>/h;  
Steam W = kg/h;  
Gas Q<sub>N</sub> = Nm<sup>3</sup>/h

## Valves features

Cone seal material	<input type="checkbox"/> PTFE/Stainless steel	<input type="checkbox"/> Stainless steel/Stainless steel	<input type="checkbox"/> PEEK / Stainless steel
Nominal pressure	PN <input type="text"/>		
Seat size (orifice)	DN <input type="text"/>		
Type of connection	<input type="checkbox"/> Flanged	<input type="checkbox"/> Threaded	<input type="checkbox"/> Welded <input type="checkbox"/> Clamp
Control function	<input type="checkbox"/> with energy storage (delivey status NO)	<input type="checkbox"/> without energy storage (blocked in last position)	
	<input type="checkbox"/> with energy storage (delivey status NC)		

## Valve system – request for quotation, continued

## Control unit features

## User display

- with touch display  
 without touch display

## Controller version

- Position controller  
 Process controller

## Communication

- |   |   |
|---|---|
| <input type="checkbox"/> Analogue   | <input type="checkbox"/> Digital (fieldbus) |
| <input type="checkbox"/> 1 analogue IN / 1 binary IN                                  | <input type="checkbox"/> Ethernet / IP      |
| <input type="checkbox"/> 1 analogue IN / 1 binary IN<br>1 analogue OUT / 2 binary OUT | <input type="checkbox"/> Profinet           |
|   | <input type="checkbox"/> Modbus TCP         |

## Electrical connection

- Cable gland (without Bus)  Multipol connection

## SIM card

- with  
 without

## Approval and Conformity (optional)

- ATEX II Cat 3G/D / IECEx  
 cULus Cert. No. 238179

Please specify article no. (if known):

## Comments

To find your nearest Bürkert office, click on the orange box →

[www.burkert.com](http://www.burkert.com)

Bei speziellen Anforderungen  
beraten wir Sie gerne.

Änderungen vorbehalten.  
© Christian Bürkert GmbH & Co. KG

1802/9\_EU-en\_00895300