

Pneumatically operated 2/2 way Valve with isolating diaphragm



- Normally closed or open
- Body material: Brass, Stainless steel
- Hermetical separation of fluids from the operating mechanism by diaphragm
- Compact design

Type 0263 can be combined with...



Type 6012

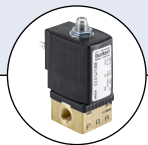

Type 6014



Type 8311

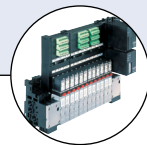

Type 8640

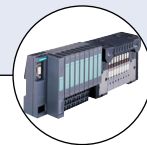

Type 8644

The externally controlled valve is pneumatically operated. It consists of a diaphragm actuator and a 2-way valve body. Between the valve body and the actuator, there is a hermetically sealed diaphragm.

The diaphragm actuator moves a spindle with valve disc against a spring and switches the valve. The spindle is designed glandless with double seal. The actuator housing is made out of epoxy resin.

Circuit function A

Single-acting actuator for pneumatically activated open/closed valve, normally closed by spring force.

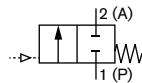

Circuit Function B

Single-acting actuator for pneumatically activated open/closed valve, normally opened by spring force.

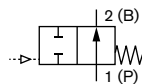

Technical data	
Body material	Brass, stainless steel
Inner part valve	Stainless steel
Actuator	Epoxy resin
Seal material	NBR, FKM, EPDM,
Medium	
NBR	neutral medium (e.g. compressed air, town gas, water, hydraulic oil)
FKM	per-solution, oxygen, hot air
EPDM	oil and fat-free medium e.g. hot water, alkaline washing and bleaching lyes
Viscosity	max. 100 mm ² /s
Medium temperature	
NBR	-10 up to +90 °C
FKM	-10 up to +100 °C
EPDM	-10 up to +100 °C
Control medium	neutral gases and liquids, in particular air, water, hydraulic liquids up to max. +90 °C
Pilot pressure	see diagram
Ambient temperature	-10 up to +90 °C
Installation	As required, preferably with actuator upright
Flow rate	measured at +20 °C, 1 bar pressure at valve inlet and free outlet
K_v value water [m³/h]:	
Pressure values [bar]	Measured as overpressure to the atmospheric pressure

Technical data *continued*

Orifice [mm]	K _v value water [m³/h]	Port connection	Pressure range of circuit function			Weight [kg]
			A normal spring [bar]	A reinforced spring [bar]	B and I normal spring [bar]	
10	1.0	G 3/8	0-2.5	0-5	0-10	0.5
12	2.1	G 1/2	0-2	0-4.5	0-10	0.6

Operating pressure chart - pilot pressure

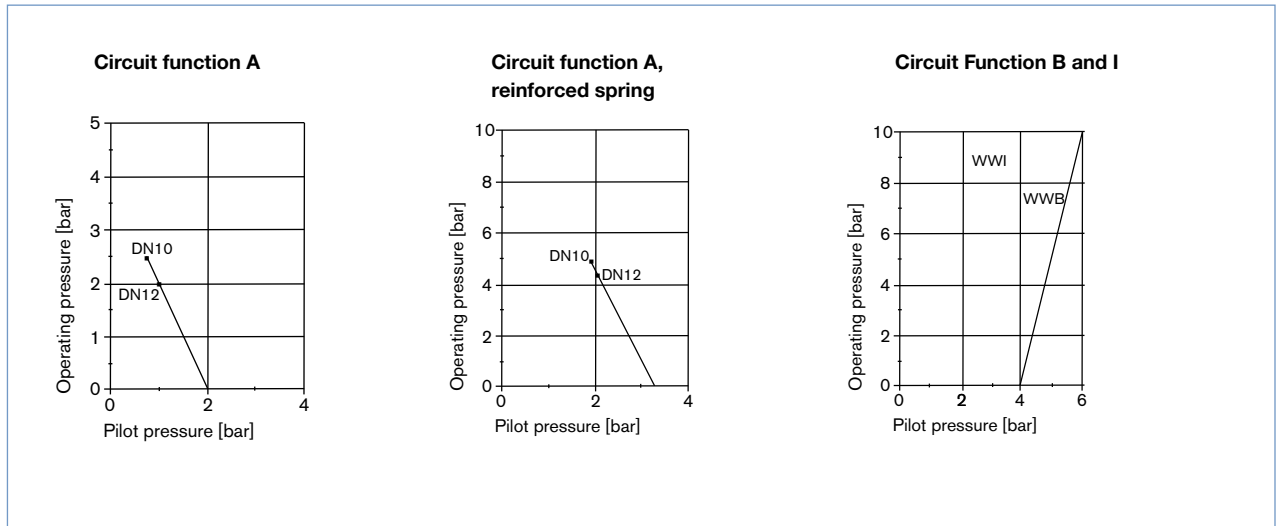

Material

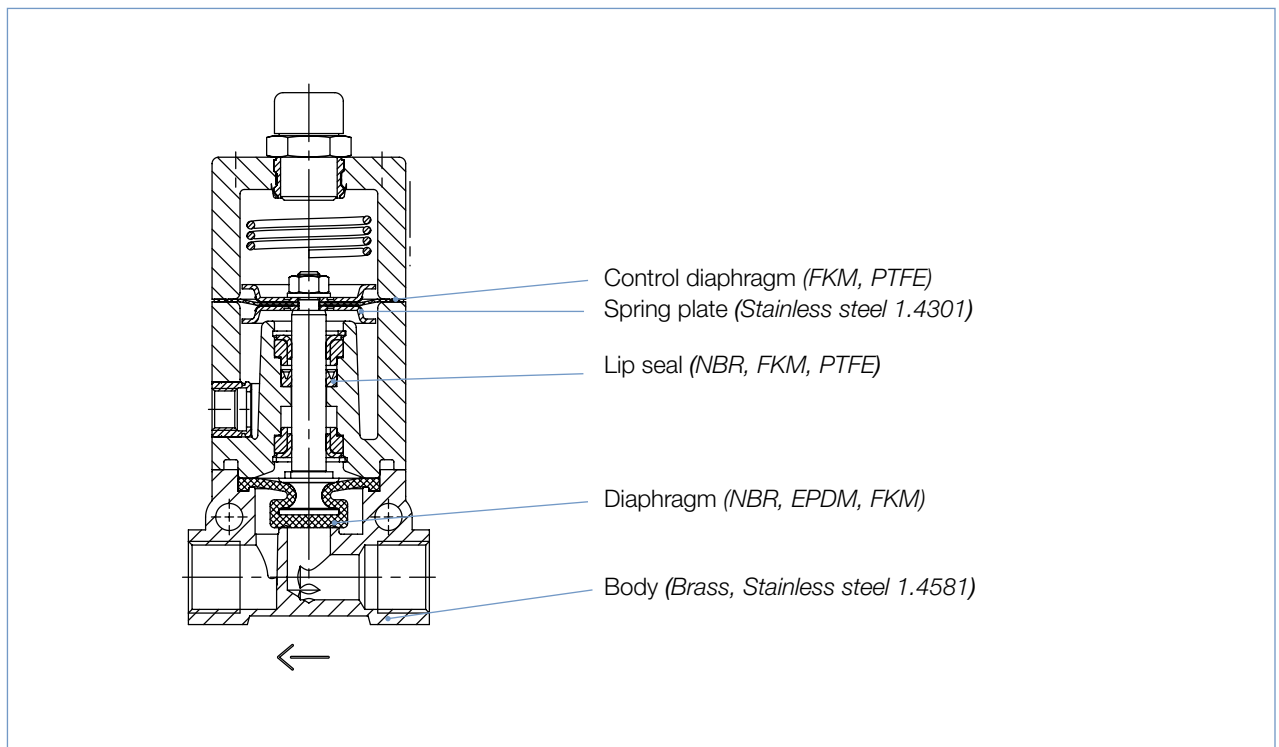

Ordering chart for valves (other versions on request)

Valves with threaded port connection

Circuit function	Orifice [mm]	Port connection	K _v value water [m ³ /h]	Spring	Pressure range [bar]	Seal material	Article no.
Brass body							
A	10	G ¾	1.0	normal	0-2.5	FKM	027963
						NBR	027342
				reinforced	0-5	EPDM	027929
						FKM	026903
	12	G ½	2.1	normal	0-2	NBR	026065
						EPDM	026094
				reinforced	0-4.5	FKM	026246
						NBR	026207
B	10	G ¾	1.0	normal	0-10	EPDM	028023
						FKM	027695
						NBR	027881
						EPDM	028980
	12	G ½	2.1	normal	0-10	FKM	028037
						NBR	026455
						EPDM	027987
						FKM	028827
		NBR	027962				
Stainless steel body							
A	12	G ½	2.1	reinforced	0-4.5	EPDM	027428
						FKM	026944
						NBR	027328

Dimensions [mm]

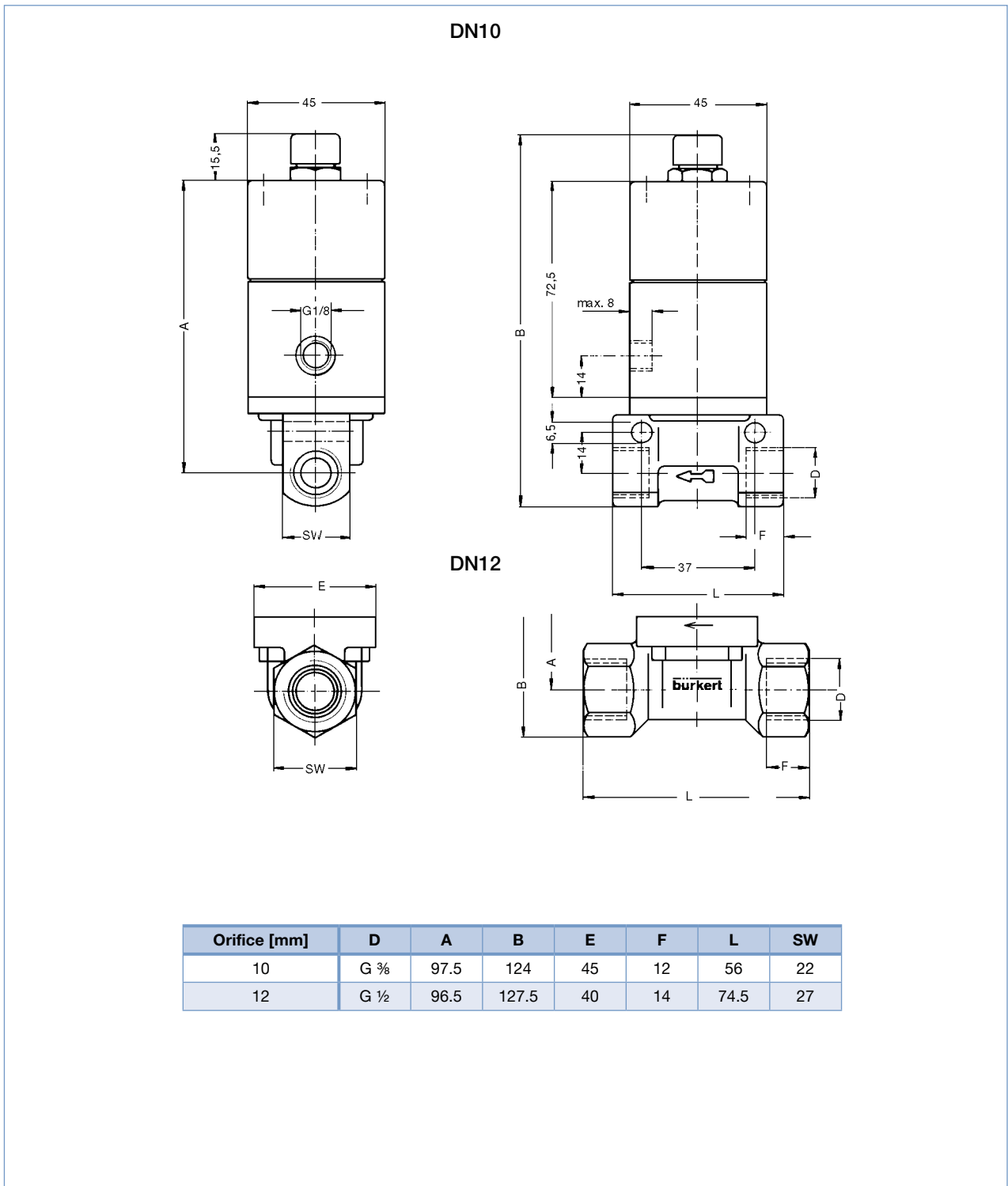

To find your nearest Bürkert facility, click on the orange box → www.burkert.com

In case of special application conditions,
please consult for advice.

Subject to alterations
© Christian Bürkert GmbH & Co. KG

1805/3_EU-en_00895230