

D5Y/D5W Series

5-digit Display Unit of DIN W72×36, W96×48mm Size

■ Features

- Various input specifications
: Static Parallel input, Dynamic Parallel input, 4/5-bit serial input, 16/20/25-bit serial input method
- Decimal point, "-" minus sign display selection function
: Display type by serial input
Display type by external DP terminal and MINUS terminal
- Positive/Negative logic input selection function
- Display digit selection function
: 4-digit (-9999 to 9999), 5-digit (0 to 99999)
- Zero blanking function selection function
- Selectable reversion function of latch signal



⚠ Please read "Safety Considerations" in the instruction manual before using.

■ Ordering Information

D	5	W	-	M	X		
Item		Digit	Size	Input	Power supply		
		5	Y	M	No-mark	No-mark	12-24VDC
		5	W	M	X*1	X*1	110/220VAC 50/60Hz
		5	W	M	M	M	Multi-input mode
		5	Y	M			DIN W72×H36mm
		5	W	M			DIN W96×H48mm
		5		M			99999 (5-digit)
		5		M			D
		5		M			Display Unit

※1: AC Power is only for D5W and it is option.

■ Specifications

Model	D5Y-M	D5W-M	D5W-MX
Power supply	12-24VDC≒		110/220VAC 50/60Hz
Allowable voltage range	90 to 110% of rated voltage		
Power consumption	Max. 1.1W		Max. 2VA
Character size	W7×H14mm		
Display method	7-segment LED display (red)		
Display digit	Selectable 4-digit (or 4 ½ digit including symbol bit), 5-digit		
Max. Clock	100Hz to 5kHz		
Input logic	Selectable positive (PNP) or negative (NPN)		
Input method	Static parallel, Dynamic parallel, 4/5-bit serial, Serial (16/20/25-bit)		
Input level	High: 5-24VDC≒, Low: 0-1.2VDC≒		
Insulation resistance	Over 100MΩ (at 500VDC megger)		
Dielectric immunity	2,000VAC 50/60Hz for 1 min		
Noise immunity	±1kV the square wave noise (pulse width: 1μs) by the noise simulator		
Vibration	Mechanical	0.75mm amplitude at frequency of 10 to 55Hz (for 1 min) in each X, Y, Z direction for 1 hour	
	Malfuction	0.5mm amplitude at frequency of 10 to 55Hz (for 1 min) in each X, Y, Z direction for 10 minutes	
Shock	Mechanical	300m/s ² (approx. 30G) in each X, Y, Z direction for 3 times	
	Malfuction	100m/s ² (approx. 10G) in each X, Y, Z direction for 3 times	
Environ-ment	Ambient temperature	-10 to 50°C, storage: -25 to 65°C	
	Ambient humidity	35 to 85%RH, storage: 35 to 85%RH	
Unit weight	Approx. 75g	Approx. 165g	Approx. 267g

※Max. Clock is for 1:1 of duty ratio (ON, OFF ratio).

※Environment resistance is rated at no freezing or condensation.

Panel Mount Type, 5-Digit Display Unit

Dimensions

D5Y-M

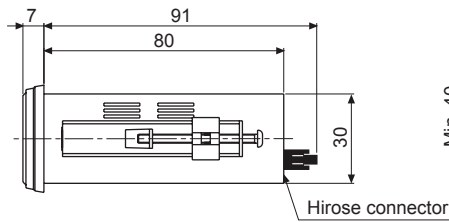
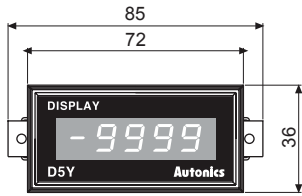

Panel cut-out (unit: mm)

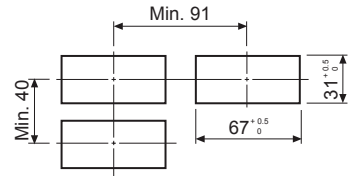

D5W-M/D5W-MX

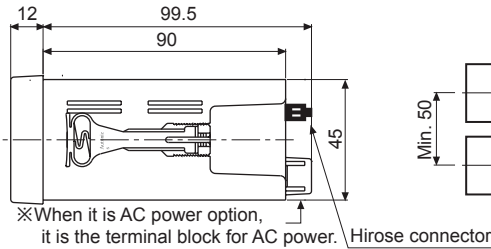
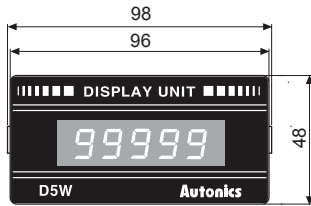

Panel cut-out

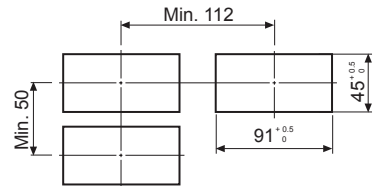

※When it is AC power option, it is the terminal block for AC power.

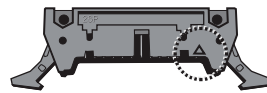

※Hirose connector pin header model: HIF3BA-26PA-2.54DS

※Hirose connector socket is not included with this unit.

Contact Hirose connector vendors for socket and cable.

[Socket: HIF3BA-26D-2.54R]

※"△" mark indicates pin 1 of Hirose connector.

Connections

Static parallel input

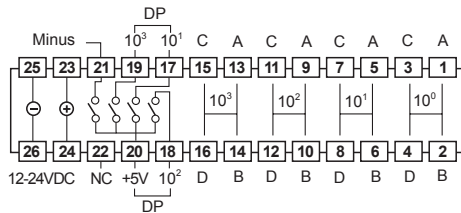

Dynamic parallel input

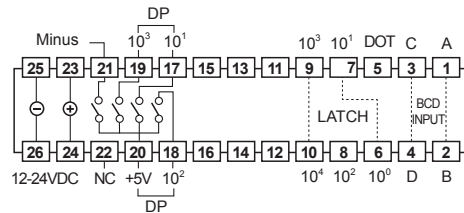

4/5-bit serial input

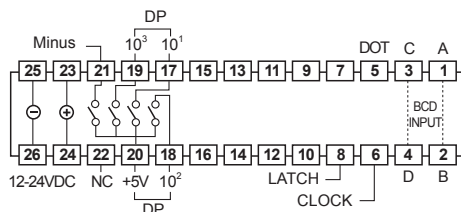

Serial input

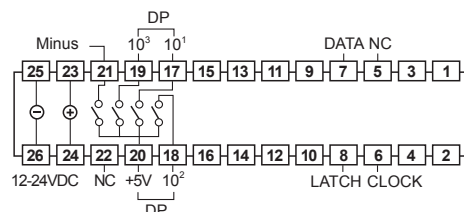

Power terminal for AC power option of D5W series

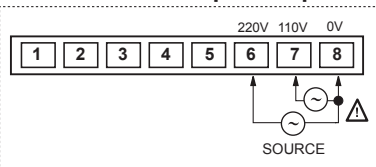

※Above terminal connection diagrams's number set by pin 1 of Hirose connector. Please note that "△" mark indicates pin 1 of Hirose connector.

※In case of Static parallel input, 5-digit cannot be used because of external terminal

※To display 5 digit in Dynamic parallel, 4/5-bit serial, serial input, display range is 0 to 99999 and it cannot display minus sign. Therefore, the applied signal to the external minus sign input terminal (pin 21) is ignored.

※Regardless of input logic, connect external DP terminal (pin 17, 18, 19) or external minus sign input terminal (pin 21) to +5V (pin 20) and it displays decimal point and minus sign.

SENSORS
CONTROLLERS
MOTION DEVICES
SOFTWARE

(J) Temperature Controllers

(K) SSRs

(L) Power Controllers

(M) Counters

(N) Timers

(O) Digital Panel Meters

(P) Indicators

(Q) Converters

(R) Digital Display Units

(S) Sensor Controllers

(T) Switching Mode Power Supplies

(U) Recorders

(V) HMIs

(W) Panel PC

(X) Field Network Devices

D5Y/D5W Series

Input Circuit

Positive logic (PNP) input

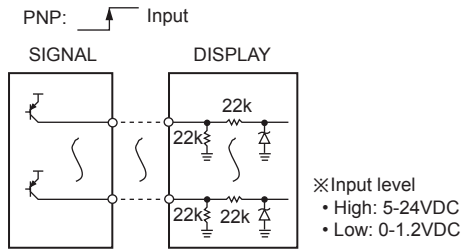

Negative logic (NPN) input

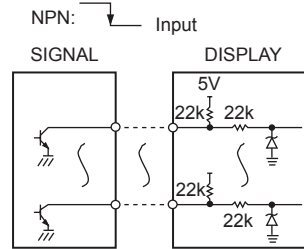

Input Timing

Parallel input

Positive logic (PNP) input

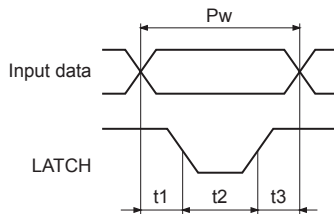

$Pw = t1 + t2 + t3$

- Pw: Min. 0.2ms
- t1: Min. 0.05ms → Data latch
- t2: Min. 0.1ms → Data move
- t3: Min. 0.05ms → Data latch

Negative logic (NPN) input

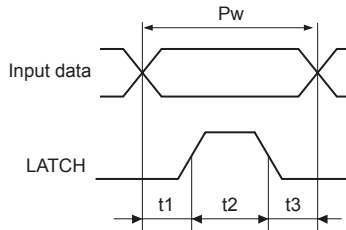

Serial input

Positive logic (PNP) input: CLOCK Max. 5kHz

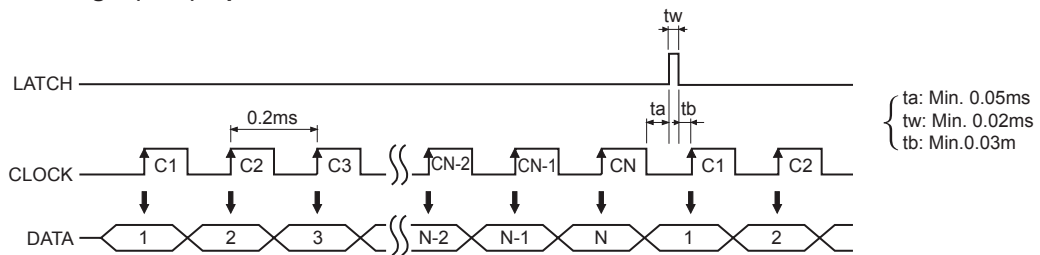

Negative logic (NPN) input: CLOCK Max. 5kHz

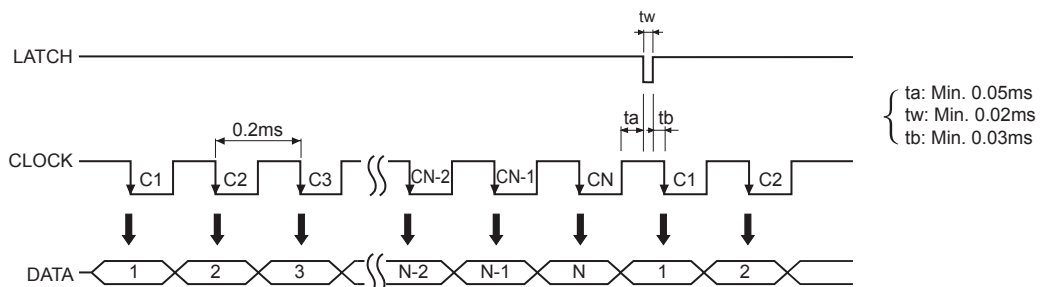

Panel Mount Type, 5-Digit Display Unit

Input Data Chart

Display	Negative (NPN) input					Positive (PNP) input				
	A	B	C	D	LATCH	A	B	C	D	LATCH
0	H	H	H	H	L	L	L	L	L	H
1	L	H	H	H	L	H	L	L	L	H
2	H	L	H	H	L	L	H	L	L	H
3	L	L	H	H	L	H	H	L	L	H
4	H	H	L	H	L	L	L	H	L	H
5	L	H	L	H	L	H	L	H	L	H
6	H	L	L	H	L	L	H	H	L	H
7	L	L	L	H	L	H	H	H	L	H
8	H	H	H	L	L	L	L	L	H	H
9	L	H	H	L	L	H	L	L	H	H
HOLD	X	X	X	X	H	X	X	X	X	L

※Input level: High → 5-24VDC, Low → 0-1.2VDC

※"X": Either high or low level can be input.

How to Select Decimal Point

- DOT and minus sign input is not serial input [SW4 = OFF]

Terminal 17-20: *8888.8*

18-20: *888.88*

19-20: *88.888*

21-20: *-8888*

OPEN: *88888*

- DOT and minus sign input is serial input [SW4 = ON]

① When it is Dynamic parallel input and 4/5-bit input, it connects with pin 5. (refer to time chart for 4-digit)

② When it is serial input, 1-bit of serial data should have DOT and minus sign and the DATA is input. (refer to time chart for 4-digit)

SENSORS

CONTROLLERS

MOTION DEVICES

SOFTWARE

(J)
Temperature
Controllers

(K)
SSRs

(L)
Power
Controllers

(M)
Counters

(N)
Timers

(O)
Digital
Panel Meters

(P)
Indicators

(Q)
Converters

(R)
Digital
Display Units

(S)
Sensor
Controllers

(T)
Switching
Mode Power
Supplies

(U)
Recorders

(V)
HMIs

(W)
Panel PC

(X)
Field Network
Devices

D5Y/D5W Series

Function Set Switches

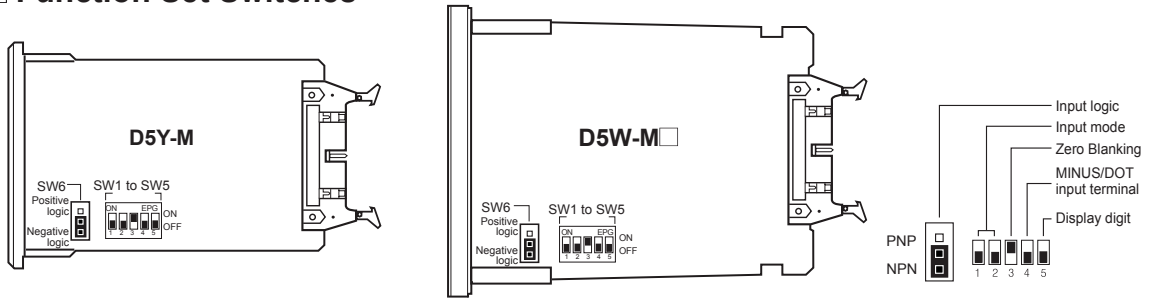

Input mode

SW1 ON OFF	SW2 ON OFF	Static parallel input
SW1 ON OFF	SW2 ON OFF	Dynamic parallel input
SW1 ON OFF	SW2 ON OFF	4/5-bit serial input
SW1 ON OFF	SW2 ON OFF	Serial input

Zero blanking function

SW3	ON OFF	Using zero blanking function
	ON OFF	Non-using zero blanking function

※Zero blanking function

It is to remove "0" indication which is no meaning.

E.g.)When indication value is "10" in 4-digit LED

• Zero blanking function is applied:

• Zero blanking function is not applied:

Minus signal/DOT (decimal point) input terminal

SW4	ON OFF	Using DOT terminal (pin 5)
	ON OFF	Using external DP (pin 17, 18, 19, 20) terminal and minus (pin 21) terminal

Factory default

Selection switch	Factory default	Selection switch	Factory default
SW1	OFF	SW5	OFF
SW2	OFF	SW6	Negative logic
SW3	ON	SW7	OFF
SW4	OFF		

Display digit

SW5	ON OFF	5-digit (0 to 99999)
	ON OFF	4-digit (-9999 to 9999)

※In case of Static parallel input, 5-digit cannot be used because of external terminal.

Input logic

SW6	PNP	Positive (PNP) input
	NPN	Negative (NPN) input

※If changing inner selecting switch when power is ON, it does not operate as a changed mode.

If the mode is changed when power is ON, please turn OFF and then turn ON the power.

Latch input signal

SW7	ON	Reverse latch signal to set logic in SW6
	OFF	Correspond latch signal to set logic in SW6

※BCD output and latch signal of low speed serial output, which are optional of Autonics pulse meter (MP5Y/W Series) and panel meter (MT4Y/W Series) is output to positive logic (NPN). If connecting D5Y/W, use it after setting SW6 to NPN and soldering (ON) the semi-contact (SW7) of inner PCB solder plate.

Panel Mount Type, 5-Digit Display Unit

■ Time Chart (4-digit)

◎ Dynamic parallel input

Function set switches: SW1 → ON, SW2 → OFF, SW3 → OFF, SW4 → ON, SW5 → OFF

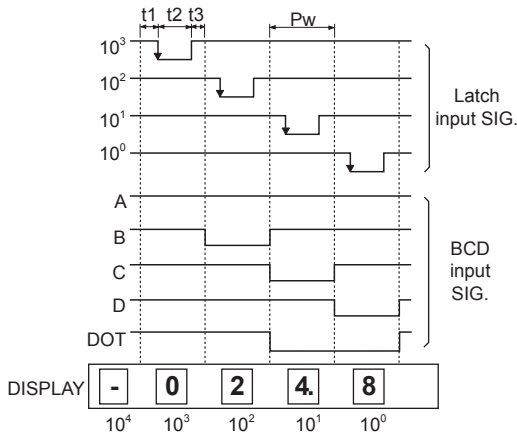

$P_w = \text{Min. } 0.2\text{ms}$

$t_1 = \text{Min. } 0.05\text{ms}$

$t_2 = \text{Min. } 0.10\text{ms}$

$t_3 = \text{Min. } 0.05\text{ms}$

※The waveform is for negative logic input (NPN).

In case of positive logic (PNP), it will be reversed.

※For 4 digit, external 10^4 LATCH input terminal is not available.

※If DOT data is inputted on 10^0 position, it displays "—" signal.
(function set switches SW4 → ON)

※Concerning decimal point and "—" signal, it can be displayed using outer DP and minus terminal not a serial input.
(function set switches SW4 → OFF)

※Latch input should be later than BCD input, otherwise, it will display the previous data.

※The left application of display indicates non-using zero blank function. If using zero blank function, the "0" on 10^3 position is not displayed.
(function set switches SW3 → ON)

◎ 4/5-bit serial input

Function set switches: SW1 → ON, SW2 → ON, SW3 → OFF, SW4 → ON, SW5 → OFF

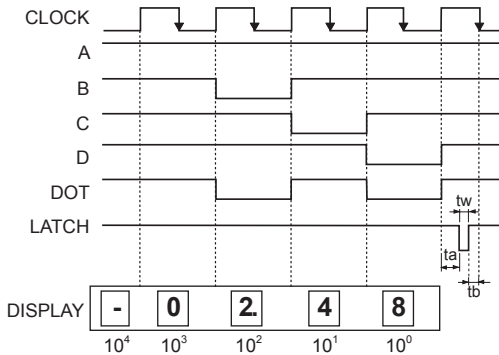

※The waveform is for negative logic input (NPN).

In case of positive logic (PNP), it will be reversed.

※If dot data is inputted on 10^0 position, it displayed "—" signal.
(function set switches SW4 → ON)

※Concerning decimal point and "—" signal, it can be displayed using outer DP and minus terminal not a serial input.
(function set switches SW4 → OFF)

※The left application of display indicates non-using zero blank function. If using zero blank function, the "0" on 10^3 position is not displayed.
(function set switches SW3 → ON)

$t_a = \text{Min. } 0.05\text{ms}$

$t_w = \text{Min. } 0.02\text{ms}$

$t_b = \text{Min. } 0.03\text{ms}$

◎ Serial input

● 20-bit DATA input: Negative logic (NPN)

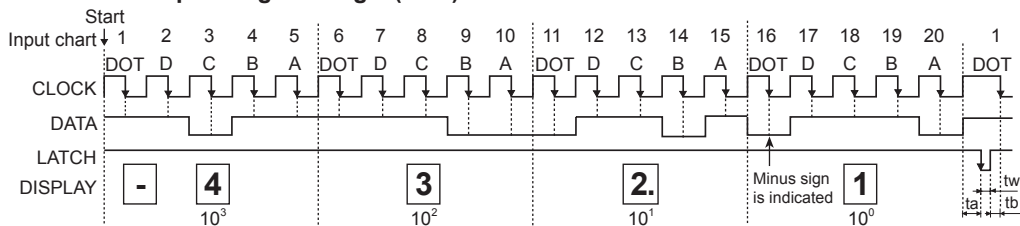

※The waveform is for negative logic input (NPN). In case of positive logic (PNP), it will be reversed.

※When DOT signal data (16th) is input on 10^0 position, minus sign is indicated.

$t_a = \text{Min. } 0.05\text{ms}$

$t_w = \text{Min. } 0.02\text{ms}$

$t_b = \text{Min. } 0.03\text{ms}$

● 16-bit DATA input: Negative logic (NPN)

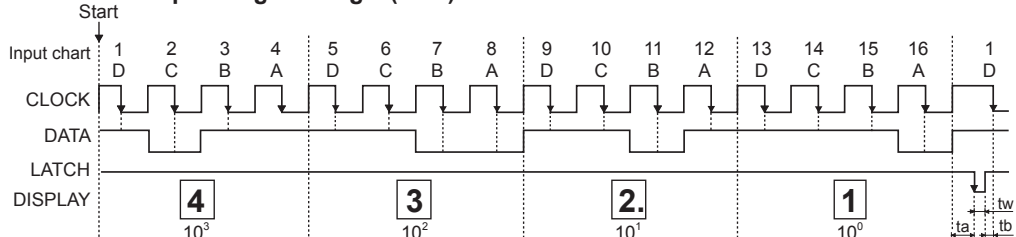

※The waveform is for negative logic input (NPN). In case of positive logic (PNP), it will be reversed.

※DATA is fixed when CLOCK is changed from high to low and held when LATCH is changed from high to low.

※DATA hold term is before next LATCH is changed from high to low.

SENSORS

CONTROLLERS

MOTION DEVICES

SOFTWARE

(J) Temperature Controllers

(K) SSRs

(L) Power Controllers

(M) Counters

(N) Timers

(O) Digital Panel Meters

(P) Indicators

(Q) Converters

(R) Digital Display Units

(S) Sensor Controllers

(T) Switching Mode Power Supplies

(U) Recorders

(V) HMIs

(W) Panel PC

(X) Field Network Devices

D5Y/D5W Series

Time Chart (5-digit)

Dynamic parallel input

Function set switches: SW1 → ON, SW2 → OFF, SW3 → OFF, SW4 → ON, SW5 → ON

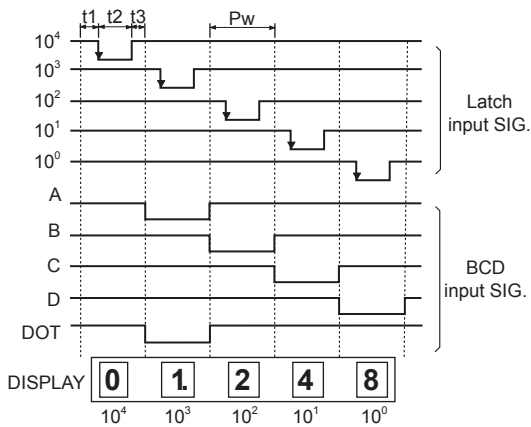

$$\begin{cases} Pw = t1+t2+t3 \\ Pw = \text{Min. } 0.2\text{ms} \\ t1 = \text{Min. } 0.05\text{ms} \\ t2 = \text{Min. } 0.10\text{ms} \\ t3 = \text{Min. } 0.05\text{ms} \end{cases}$$

- ※The waveform is for negative logic input (NPN). In case of positive logic (PNP), it will be reversed.
- ※It is impossible to display the "—" at 5-digit line.
- ※LATCH input should be later than BCD input, otherwise, it will display the previous DATA.
- ※The left application of display indicates non-using zero blank function. If using zero blank function, the "0" on 10^4 position is not displayed. (function set switches SW3 → ON)

4/5-bit serial input

Function set switches: SW1 → ON, SW2 → ON, SW3 → OFF, SW4 → ON, SW5 → ON

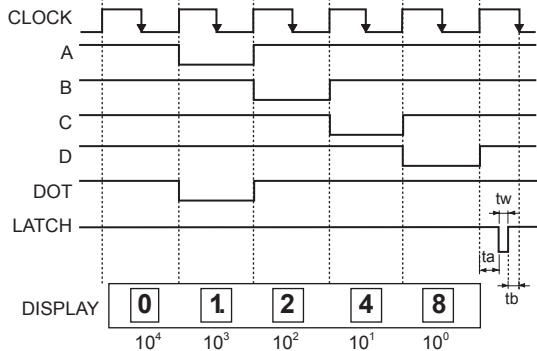

- ※The waveform is for negative logic input (NPN). In case of positive logic (PNP), it will be reversed.
- ※It is impossible to display the "—" at 5-digit line.
- ※The left application of display indicates non-using zero blank function, the "0" on 10^4 position is not displayed. (function set switches SW3 → ON)

$$\begin{cases} ta = \text{Min. } 0.05\text{ms} \\ tw = \text{Min. } 0.02\text{ms} \\ tb = \text{Min. } 0.03\text{ms} \end{cases}$$

Serial input

25-bit DATA input: Negative logic (NPN)

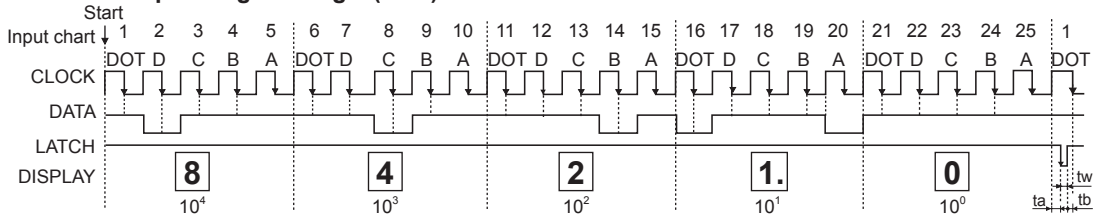

$$\begin{cases} ta: \text{Min. } 0.05\text{ms} \\ tw: \text{Min. } 0.02\text{ms} \\ tb: \text{Min. } 0.03\text{ms} \end{cases}$$

20-bit DATA input: Negative logic (NPN)

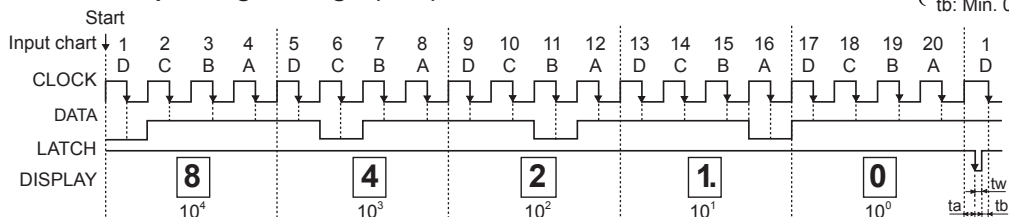

- ※The waveform is for negative logic input (NPN). In case of positive logic (PNP), it will be reversed.
- ※Minus sign cannot be indicated in 5-digit type. [The input of DOT signal on 100 position and MINUS terminal (pin 21) is ignored.]
- ※DATA is fixed when CLOCK is changed from high to low and held when LATCH is changed from high to low.
- ※DATA hold term is before next LATCH is changed from high to low.

Panel Mount Type, 5-Digit Display Unit

■ Proper Usage

- **Storage**
Avoid direct ray of light when keeping this unit long time, and keep it under -25 to 65°C, 35 to 85%RH of relative humidity.
- **Noise**
In case of the product (D5W-MX) using AC power, inflow of noise through a power line is a major circuit built-in small product. Therefore, use an absorbing circuit such as outer line filter and varistor when abnormal voltage occurs in the same line by power relay, magnet S/W, using a high-frequency machine, high voltage of spark of lightning stroke.

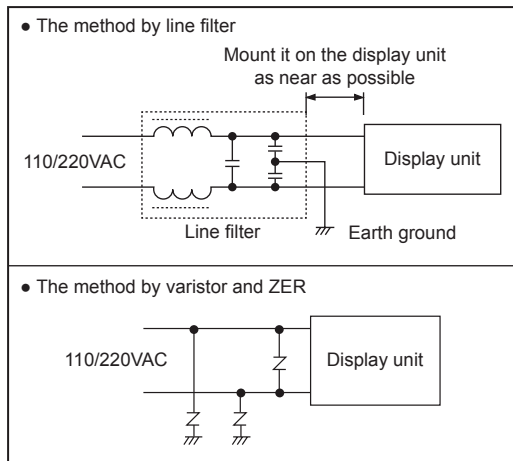

- Input signal line should be short as much as possible. If the line is too long, it is easy to affect noise.
- If the time of input signal is overlapped, it may occur faint light.
- Oil, soot or dust must not be flown into the product.
- A decimal point and minus sign can be displayed with the outer DP terminal and the minus terminal when signal level is "High". (high level: 5V-24VDC)
- Because Hirose connector has both power line (12-24VDC) and data signal line, please connect the lines after checking the connection figure.

■ Case Detachment

● D5Y-M

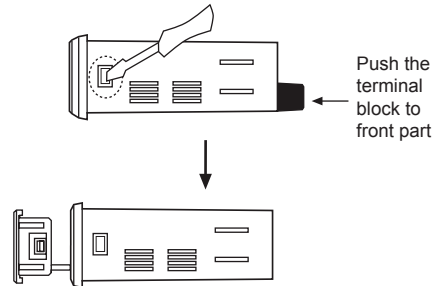

Widen the both inside of lock devices with a driver, and push the terminal block to the direction of front part.

● D5W-M / D5W-MX

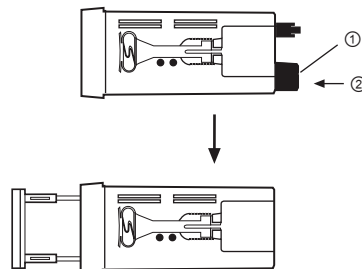

Push the lock part on the side to the direction ①, and then push the terminal block to the direction ② to detach the case.

- ※Be careful in order not to be wounded.
- ※**Turn OFF the power** before detaching the case.

SENSORS
CONTROLLERS
MOTION DEVICES
SOFTWARE

(J) Temperature Controllers
(K) SSRs
(L) Power Controllers
(M) Counters
(N) Timers
(O) Digital Panel Meters
(P) Indicators
(Q) Converters
(R) Digital Display Units
(S) Sensor Controllers
(T) Switching Mode Power Supplies
(U) Recorders
(V) HMIs
(W) Panel PC
(X) Field Network Devices