



730 Series

Heavy Duty Relays

730 Series are designed with DIN rail mount & Panel direct mount, and Quick connector (#250) & terminal screw type, reliability and long life, and pushbutton allows manual operation of the relay



Specifications

Part Numbers	Screw Terminal & DIN Rail Mount Type	730-1TR - 220VAC 730-1TR - 110VAC 730-1TR - 24VDC	730-2TR - 220VAC 730-2TR - 110VAC 730-2TR - 24VDC
	Quick Connector (#250) & DIN Rail Rail Mount Type	730-1QR - 220VAC 730-1QR - 110VAC 730-1QR - 24VDC	730-2QR - 220VAC 730-2QR - 110VAC 730-2QR - 24VDC
	Screw Terminal & Panel Mount Type	730-1TB - 220VAC 730-1TB - 110VAC 730-1TB - 24VDC	730-2TB - 220VAC 730-2TB - 110VAC 730-2TB - 24VDC
Contact	Quick Connector (#250) & Panel Mount Type	730-1QB - 220VAC 730-1QB - 110VAC 730-1QB - 24VDC	730-2QB - 220VAC 730-2QB - 110VAC 730-2QB - 24VDC
	Configuration	SPST (1NO)	
	Material	Silver alloy	
	Max. Switching current	30A	25A
	Rated Max. Resistive Load	30A at 30VDC/277VAC	
Coil Spec.	Min. Switching requirement	100mA 5VDC	
	Voltage range	6VDC to 110VDC, 6VAC to 240VAC	
	Power consumption	DC: approx. 1.9W 6-48VAC: 1.7-1.9VA 100/120VAC: 1.9-2.7VA 200/240VAC: 1.8-2.6VA	
	Minimum operating voltage	80% of the rated coil voltage	
	Dropout voltage	DC Coil: 10% of rated voltage AC Coil: 30% of rated voltage	
	Operating Time	30ms	
	Dropout time	30ms	
	Insulation resistance	100MΩ at 500V DC	
	Dielectric Strength	Between Contact(2a): 2,000 Vrms 1Min. Between Contact & Coil: 4,000Vrms 1Min.	
	General Info.	Mechanical life	1,000,000 operations
Electrical life		100,000 operations	
Vibration resistant		10~55Hz at double amplitude of 1.5mm	
Ambient temperature		-10 ~ +60°C (-14°F ~ 140°F) at non freezing	
Ambient humidity		35% ~ 80% RH	
Weight		TB Type: 90g (3.2oz), QB Type: 120g (4.2oz)	

Dimensions (unit: mm)

730-1TR

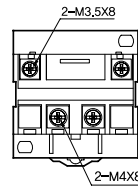

730-2TR

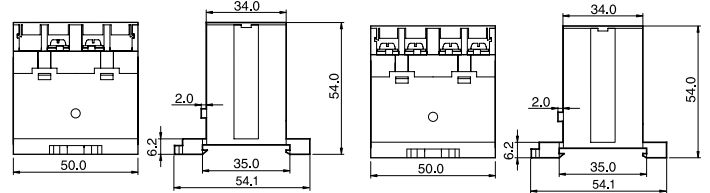
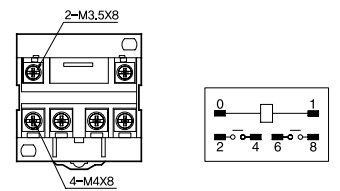

730-1QR

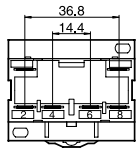

730-2QR

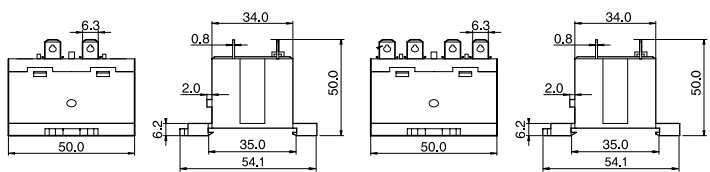
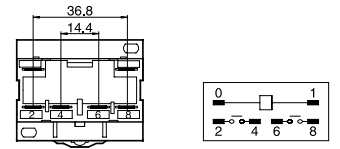

730-1TB

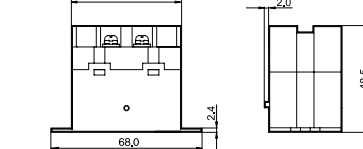
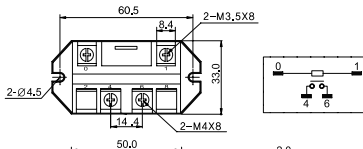

730-2TB

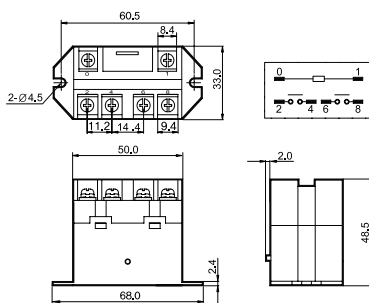

730-1QB

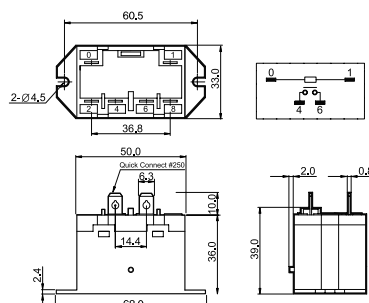

730-2QB

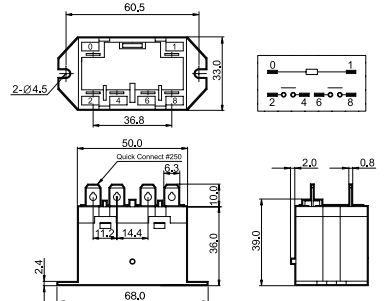

* Min. Switching requirement: If load require low current, you may consider a troubleshooting for operation. For a proper operation, a dummy resistance should be added in parallel on the load to provide current more than min. Switching requirement (100mA 5VDC)